



YOUR SMART
SOLUTION

CATALOGO GENERALE

GENERAL CATALOGUE

20
20

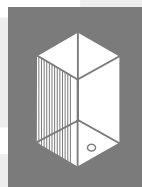
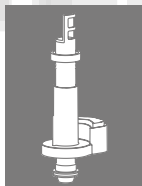
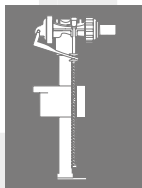
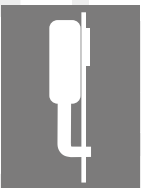

40th
YEARS
ANNIVERSARY



YOUR SMART
SOLUTION

Beta[®]

NANOTEK

AMPHORA

PROFESSIONAL
Line

*"Soluzioni per il tuo bagno,
alla portata di tutti"*

*"Solutions for your bathroom,
accessible to everyone"*



40 anni di storia: oltre 500 milioni di prodotti venduti ed installati in più di 60 paesi nel mondo

40 years of history: over 500 million products sold and installed in more than 60 countries worldwide



CR nasce nel 1980, ponendo le sue radici nella tradizione industriale sviluppata e tramandata dalle famiglie Reggiani e Cavani. Il frutto di questa collaborazione risiede nella mutuale ricerca dinamica di eccellenza tecnologica in progettazione e automatizzazione oltre al continuo sviluppo di know-how tecnico e commerciale.

La realtà CR è altamente specializzata nella produzione a ciclo completo di sistemi di scarico e articoli idrosanitari in plastica, garantendo vitale attenzione alle componenti del design, qualità e funzionalità della propria offerta.

Ad oggi CR si inquadra in un'ottica internazionale di Gruppo (CR GROUP) avvalendosi dei propri stabilimenti produttivi e logistici in Italia e all'estero.

Coesione, sinergia e investimenti in ricerca e sviluppo permettono a CR di offrire un'ampia gamma di prodotti in grado di coniugare alta qualità, efficienza tecnica ed elevato grado di soddisfazione della clientela.

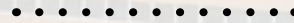

CR was founded in 1980 placing its roots in the industrial tradition developed and handed down by Reggiani and Cavani families. The result of this collaboration lies in the mutual dynamic research of technological excellence in design and automation as well as the continuous development of technical and commercial know-how.

The CR reality is highly specialized in the production of complete cycle of exhaust systems and hydro-sanitary plastic articles, ensuring vital attention to design components, quality and functionality of its offer.

Today CR is part of an international Group approach (CR GROUP), making use of its production plants and logistics in Italy and abroad.

Cohesion, synergy and investments in research and development allow CR to offer a wide range of products able to combine high quality, technical efficiency and high customer satisfaction.



Castelfranco Emilia

MODENA, ITALY



GESTIONE E CONTROLLO



Esperienza industriale e maturità tecnologica hanno permesso a CR di sviluppare un processo di gestione e controllo centralizzato. Oggi l'azienda è caratterizzata da una filiera produttiva precisa e dinamica avente come obiettivo l'equilibrio gestionale tra componente umana e meccanica.

The industrial experience and technological maturity have allowed CR to develop a centralised management and control process. Today the company is characterized by a precise and dynamic production chain having the purpose to maintain an efficient balance between the human and mechanical component.

KNOW-HOW E CAPACITA' PRODUTTIVA



Dislocandosi in diversi impianti industriali di stampaggio a ciclo continuo, CR garantisce al mercato una capacità produttiva di ampia portata distinguendosi, allo stesso tempo, per l'accurata attenzione rivolta all'ecosostenibilità. Gli stabilimenti produttivi di ultima generazione si avvalgono di sorgenti fotovoltaiche e processi di riciclaggio dei materiali al fine di ridurre al minimo l'impatto ambientale.

Being located in several continuous cycle industrial molding plants, CR guarantees a large production capacity to the market, distinguishing itself, at the same time, for the attention addressed to the eco-sustainability. The latest generation production plants carry out photovoltaic sources and materials recycling processes in order to minimise the environmental impact.



AUTOMAZIONE INDUSTRIALE



Gli stabilimenti produttivi e logistici di CR rispecchiano la filosofia dell' "automatismo snello", declinata in robotizzazione antropomorfa dedicata e logistica intelligente adattiva. Razionalizzare la struttura industriale di stampaggio ha come finalità l'efficiamento dei processi produttivi, la riduzione marginale di sprechi e la prontezza di risposta alle variazioni stagionali di capacità richiesta.

The production and logistics plants of CR reflect the philosophy of the "light automatism" concept, declined in dedicated anthropomorphic robotization and adaptive intelligent logistics. The aim of rationalising the industrial moulding structure is the efficiency of the production process, the marginal reduction of waste and the readiness to respond to seasonal variations in required capacity.

SERVIZIO E LOGISTICA



La logistica riveste un ruolo chiave nella struttura dinamica della filiera CR, adattandosi alle esigenze della clientela in termini di rapidità di consegna e personalizzazione del servizio richiesto.

Logistics plays a key role in the dynamic structure of the CR industry, fitting customer needs in terms of fast delivery operations and customization of the required service.



CASSETTE ESTERNE - EXTERNAL WC CISTERNS

0

Concept 1 *	14	Concept pneu *	38
Concept 2 *	16	Concept monoblock 1 *	40
Delta 1 *	18	Concept monoblock 2 *	42
Delta 2 *	20	Idrocassetta *	44
Sfera 1 *	22	Polo	46
Sfera 2 *	24	Angolo	48
Plus 1	26	Concept alta *	50
Plus 2	28	Alfa	52
Smart	30	Cabrio	54
Beta	32	Ricambi cassette - Spare parts for wc cisterns ...	56
Export	34		



CASSETTE INCASSO - BUILT-IN WC CISTERNS

66

Fusion	68
Placche - Plates	74
Ricambi Fusion - Fusion spare parts	75



GALLEGGIANTI - FILLING VALVES

76

Nanotek *	78
Rambo *	82
Blue	84
1515	86
1510NF	87
1511L	88
Ricambi galleggianti - Filling valves spare parts	88
Sfere - Floating balls	89



COMPONENTI PER CASSETTE WC - COMPONENTS FOR WC CISTERNS

90

Tubi di scarico - Outlet pipes	92
Morsetti - Bowl gaskets	102
Guarnizioni - Gaskets	104
Meccanismi per cassetta alta in porcellana - Flush valves for high level vitreous-china cisterns	106
Pulsanti pneumatici + Kit di conversione - Pneumatic push-buttons + Conversion kit	108
Rubinetto a squadra e flessibile - Chromate brass tap and flexible hose	110
Porta rotolo e idrokit - Toilet paper roll-holder and idrokit	111



MECCANISMI PER MONOBLOCCO - VALVES FOR TWO-PIECE TOILET

112

Meccanismi - Flush valves	114
Ricambi meccanismi - Flush valves spare parts	119



SIFONAME - SIPHONS

120

Canaline doccia - Shower drains *	122	Sifoni a fiasco - Flask siphons	152
Pilette sifonate doccia - Shower tray drains *	124	Sifoni liberi - Free siphons	156
Colonne vasca - Bathtub siphons	129	Pilettoni - Drains 3"1/2 for kitchen	157
Chiusini gravitazionali per interno - Floor drains*	130	Pilette per lavello - Drains for kitchen	158
Ricambi linea gravitazionale - Spare parts	132	Sifoni lavatrice - Washing-machine siphons	160
Sifoname lavabo/bidet - Siphons for bathroom	134	Riduzioni - Reductions	161
Tubi estensibili - Extensible pipes	136	Ricambi per sifoname - Spare parts	162
Biscione e raccordi - Flexible pipe roll	140	Chiusini per esterno - Outdoor floor drains	166
Sifoni a U - U siphons	144	Tubi uscita wc e manicotti - Outlets for wc	167
Sifoni a bottiglia - Bottle siphons	148		



SEDILI WC - TOILET SEATS

168

Everest (soft close) *	170
Java (soft close) *	171
Malaga (soft close) *	172
Creta (soft close) *	173
Komodo	174
Boxer	175
K2 Evo	176
K2 classic	177
Atlantic	178
Z3	179
Baby	180
Legno	181
Ricambi sedili - Toilet seats spare parts	182



PILOZZI - UTILITY SINKS

186

Pilozzi e griglie - Utility sinks and grids	188
Mobili abbinabili a pilozzi - Furnitures for utility sinks	192
Ricambi - Utility sinks spare parts	193



AMPHORA

LINEA LAVANDERIA - LAUNDRY LINE

194

Pangea	196
Futura	200
Queen	204
Ontario	206
Pratika	210
Basic	214
Rocky	216
Kubo	220
Junior	222
Pensili Junior e Simpaty - Junior cabinets and Simpaty	226
Compact	228
Micro	232
Slim	233
Lavatoi coprilavatrice con lavatrice a vista	236
Lavatoi coprilavatrice chiusi	240
Proteggilavatrice	242
Sottoceramica	246
Ricambi e accessori lavatoi - Spare parts and accessories	247



BOX DOCCIA E VASCA - SHOWER AND BATH CABIN

254

Superbruco doccia - Superbruco shower	256
Superbruco vasca - Superbruco bathtub	258
Bruco doccia - Bruco shower	260
Bruco vasca - Bruco bathtub	262



INDICE ARTICOLI - ARTICLE INDEX

264

Espositori - Displays	272
-----------------------	-----



*

PROFESSIONAL Line

Linea di prodotti di ultima generazione, prettamente dedicata ai professionisti dell'installazione, distinta per la ricerca di performance, funzionalità e design.



LEGENDA



Installazione in posizione a zaino o media posizione
Low or medium level installation



Installazione in posizione alta
High level installation



Installazione in posizione monoblocco
Monoblock installation



Tasto economizzatore d'acqua start/stop
Single button with water-saving start/stop



Doppio scarico
Double flush



Scarico singolo
Single flush



Isolamento anti-condensa ed insonorizzante
Anti-condensate and soundproofing insulation



Attacco idrico destro, sinistro
e posteriore centrale
*Water connection right, left
and central back*

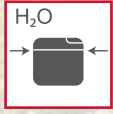

Attacco idrico destro o sinistro
Water connection right or left



Risparmio acqua
Water saving



Funzionamento silenzioso
Silent functioning



Conforme alla normativa CE EN 14055
Comply to CE standard EN 14055



Montaggio semplice e veloce
Easy and fast mounting









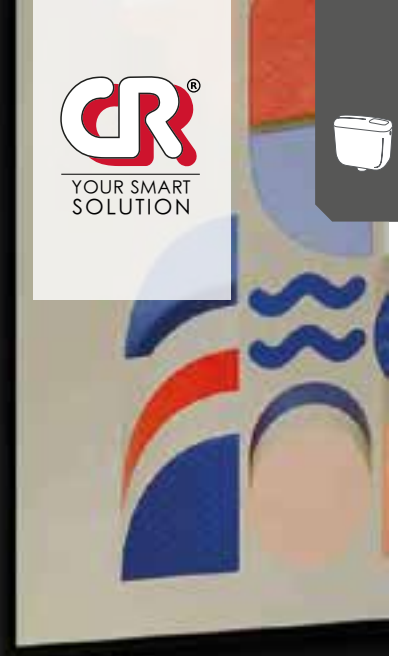





















































CASSETTE ESTERNE EXTERNAL WC CISTERNS

La linea di cassette di scarico a zaino CR, da 40 anni core-business aziendale, equilibrio perfetto tra tecnica, tradizione e modernità





























The range of CR exposed wc-cisterns, for 40 years the company's core business, the perfect balance between technique, tradition and modernity































	CONCEPT 1  Pag. 12,13	CONCEPT 2  Pag. 14,15	DELTA 1  Pag. 16,17	DELTA 2  Pag. 18,19	SFERA 1  Pag. 20,21
Tipo di installazione <i>Type of installation</i>	 Zaino o media posizione <i>Low or medium position</i>	 Zaino o media posizione <i>Low or medium position</i>	 Zaino o media posizione <i>Low or medium position</i>	 Zaino o media posizione <i>Low or medium position</i>	 Zaino o media posizione <i>Low or medium position</i>
Tipo di scarico <i>Type of outlet</i>	 Start-stop	 Doppio scarico <i>Double flush</i>	 Start-stop	 Doppio scarico <i>Double flush</i>	 Start-stop
Tipo di azionamento <i>Type of mechanism</i>	 Meccanica e pneumatica <i>Mechanical and pneumatic</i>	 Meccanica <i>Mechanical</i>	 Meccanica <i>Mechanical</i>	 Meccanica <i>Mechanical</i>	 Meccanica <i>Mechanical</i>
Attacchi idrici <i>Water connection</i>	 Tre attacchi idrici <i>Three water connections</i>	 Tre attacchi idrici <i>Three water connections</i>	 Tre attacchi idrici <i>Three water connections</i>	 Tre attacchi idrici <i>Three water connections</i>	 Tre attacchi idrici <i>Three water connections</i>
Isolamento anticondensa <i>Anti insulation</i>	 Isolamento anti-condensa <i>Anti-condensate insulation</i>	 Isolamento anti-condensa <i>Anti-condensate insulation</i>	 Isolamento anti-condensa <i>Anti-condensate insulation</i>	 Isolamento anti-condensa <i>Anti-condensate insulation</i>	 Isolamento anti-condensa <i>Anti-condensate insulation</i>

	EXPORT  Pag. 32,33	CONCEPT PNEU  Pag. 36,37	CONCEPT MONOBLOCK 1  Pag. 38,39	CONCEPT MONOBLOCK 2  Pag. 40,41	IDROCASSETTA CONCEPT 2  Pag. 42,43
Tipo di installazione <i>Type of installation</i>	 Zaino o media posizione <i>Low or medium position</i>	 Zaino o media posizione <i>Low or medium position</i>	 Posizione monoblocco <i>Monoblock position</i>	 Posizione monoblocco <i>Monoblock position</i>	 Zaino o media posizione <i>Low or medium position</i>
Tipo di scarico <i>Type of outlet</i>	 Start-stop	 Start-stop	 Start-stop	 Doppio scarico <i>Double flush</i>	 Doppio scarico <i>Double flush</i>
Tipo di azionamento <i>Type of mechanism</i>	 Meccanica <i>Mechanical</i>	 Pneumatica <i>Pneumatic</i>	 Meccanica <i>Mechanical</i>	 Meccanica <i>Mechanical</i>	 Meccanica <i>Mechanical</i>
Attacchi idrici <i>Water connection</i>	 Due attacchi idrici <i>Two water connections</i>	 Tre attacchi idrici <i>Three water connections</i>	 Tre attacchi idrici <i>Three water connections</i>	 Tre attacchi idrici <i>Three water connections</i>	 Tre attacchi idrici <i>Three water connections</i>
Isolamento anticondensa <i>Anti insulation</i>	 Isolamento anti-condensa <i>Anti-condensate insulation</i>	 Isolamento anti-condensa <i>Anti-condensate insulation</i>	 Isolamento anti-condensa <i>Anti-condensate insulation</i>	 Isolamento anti-condensa <i>Anti-condensate insulation</i>	 Isolamento anti-condensa <i>Anti-condensate insulation</i>



	SFERA 2  Pag. 22,23	PLUS 1  Pag. 24,25	PLUS 2  Pag. 26,27	SMART  Pag. 28,29	BETA  Pag. 30,31
Tipo di installazione <i>Type of installation</i>	 Zaino o media posizione <i>Low or medium position</i>	 Zaino o media posizione <i>Low or medium position</i>	 Zaino o media posizione <i>Low or medium position</i>	 Zaino o media posizione <i>Low or medium position</i>	 Zaino o media posizione <i>Low or medium position</i>
Tipo di scarico <i>Type of outlet</i>	 Doppio scarico <i>Double flush</i>	 Start-stop	 Doppio scarico <i>Double flush</i>	 Start-stop	 Start-stop
Tipo di azionamento <i>Type of mechanism</i>	 Meccanica <i>Mechanical</i>	 Meccanica <i>Mechanical</i>	 Meccanica <i>Mechanical</i>	 Meccanica <i>Mechanical</i>	 Meccanica <i>Mechanical</i>
Attacchi idrici <i>Water connection</i>	 Tre attacchi idrici <i>Three water connections</i>	 Tre attacchi idrici <i>Three water connections</i>	 Tre attacchi idrici <i>Three water connections</i>	 Tre attacchi idrici <i>Three water connections</i>	 Tre attacchi idrici <i>Three water connections</i>
Isolamento anticondensa <i>Anti insulation</i>	 Isolamento anti-condensa <i>Anti-condensate insulation</i>	 Isolamento anti-condensa <i>Anti-condensate insulation</i>	 Isolamento anti-condensa <i>Anti-condensate insulation</i>	 Isolamento anti-condensa <i>Anti-condensate insulation</i>	

	POLO  Pag. 44,45	ANGOLO  Pag. 46,47	CONCEPT ALTA  Pag. 48,49	ALFA  Pag. 50,51	CABRIO  Pag. 52,53
Tipo di installazione <i>Type of installation</i>	 Zaino o media posizione <i>Low or medium position</i>	 Zaino o media posizione <i>Low or medium position</i>	 Posizione alta <i>High position</i>	 Posizione alta <i>High position</i>	 Posizione alta <i>High position</i>
Tipo di scarico <i>Type of outlet</i>	 Start-stop	 Start-stop	 Scarico singolo <i>Single flush</i>	 Scarico singolo <i>Single flush</i>	 Scarico singolo <i>Single flush</i>
Tipo di azionamento <i>Type of mechanism</i>	 Meccanica <i>Mechanical</i>	 Meccanica <i>Mechanical</i>	 A tirare <i>Pull functioning</i>	 A tirare <i>Pull functioning</i>	 A tirare <i>Pull functioning</i>
Attacchi idrici <i>Water connection</i>	 Due attacchi idrici <i>Two water connections</i>	 Due attacchi idrici <i>Two water connections</i>	 Tre attacchi idrici <i>Three water connections</i>	 Due attacchi idrici <i>Two water connections</i>	 Due attacchi idrici <i>Two water connections</i>
Isolamento anticondensa <i>Anti insulation</i>	 Isolamento anti-condensa <i>Anti-condensate insulation</i>	 Isolamento anti-condensa <i>Anti-condensate insulation</i>	 Isolamento anti-condensa <i>Anti-condensate insulation</i>		

CONCEPT 1

Scarico singolo - Single flush



Caratteristiche tecniche

- Installazione bassa a zaino o media posizione
- Predisposizione a funzionamento pneumatico
- Scocca in ABS con trattamento anti invecchiamento
- Capacità 8 litri con possibilità di regolazione
- Omologazione 7 litri per normativa CE EN 14055
- Tasto economizzatore d'acqua start/stop
- Coibentazione anticondensa ed insonorizzante
- Allacciamento idrico destro, sinistro o posteriore centrale
- Galleggiante 3/8" compatto, rapido e silenzioso
- Accessoriata di tubo

Technical features

- For low or medium level installation
- Predisposition to pneumatic functioning
- ABS body with anti-age treatment
- 8 liters capacity with the possibility to adjust the amount of water
- 7 liters homologation according to CE standard EN 14055
- Single button with water-saving start/stop
- Anti-condensate and soundproofing insulation
- Water connection right, left or central back
- 3/8" compact filling valve, safe, quick and silent
- Equipped with pipe



DOWNLOAD

Vedi scheda tecnica
View technical sheet



La linea di cassette wc "Concept" può essere accessoriata con **PORTA-ROTOLO**, installabile lateralmente nel fusto della cassetta (vedi pag. 111)

"Concept" wc cistern line can be equipped with **TOILET PAPER ROLL-HOLDER**, installable in the sides of the cisterns' body (see page 111)

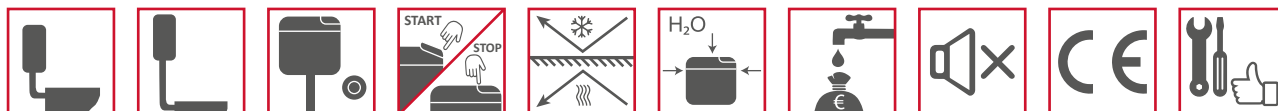

Art. / Item

Descrizione / Models

EAN

1000C1	CONCEPT 1 bianca start/stop, con predisposizione pneumatica e rubinetto CONCEPT 1 start/stop system, with pneumatic predisposition and tap, white	8029954080007
1185N/01	Porta-rotolo cromato per cassette wc Toilet paper roll-holder for wc cisterns	8029954005260

Equipaggiamento - Equipment



Galleggiante 3/8"
Rambo, codolo ottone
Filling valve Rambo,
with 3/8" brass tang

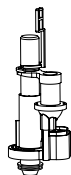

Meccanismo di scarico
Flushing valve

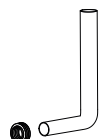

Tubo di scarico
Outlet pipe



Isolamento anti-condensa
Anti-condensation insulation



Kit di fissaggio
Fixing kit



Rubinetto a squadra
Chromate tap



Pulsante pneu e tubetto 300 cm
Pneu push-button and pipe 300 cm



Canalina rigida e fissaggi /
Guaina da incasso
Fixing kit with rigid tube /
Sheath

1000C1





PROFESSIONAL

Line

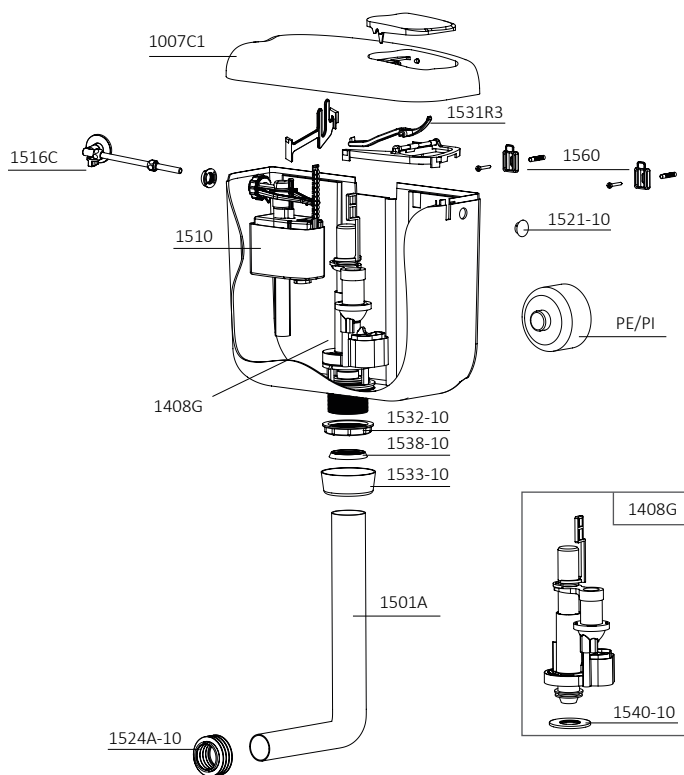





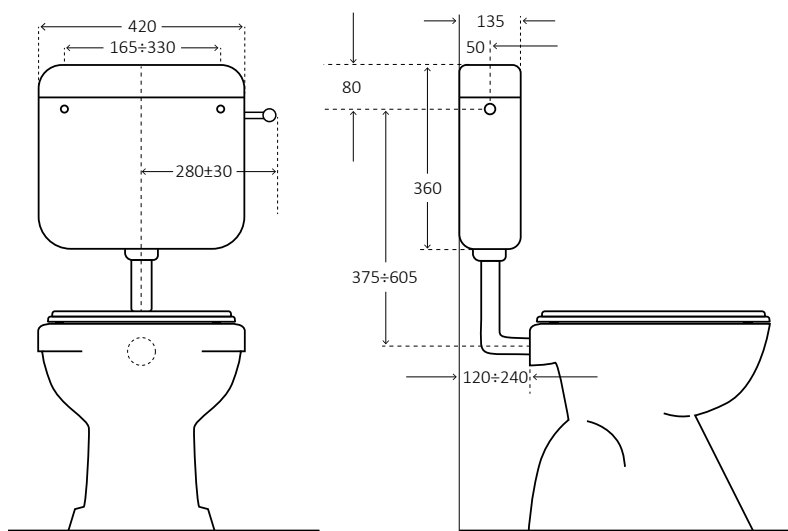

Ricambi - Spare parts (Dettagli - Details pag. 56)

1007C1	Coperchio completo di pulsante <i>Cover complete with push button</i>
1408G	Meccanismo di scarico pneumatico <i>Pneumatic outlet valve</i>
1501A	Tubo di scarico Ø 50x40 lunghezza mm 350x245 <i>Pipe for wall low-level cistern Ø 50x40 mm 350x245</i>
1510	Galleggiante Rambo 3/8" codolo ottone <i>Rambo filling valve 3/8" brass tang</i>
1516C	Rubinetto a squadra 1/2" ottone cromato per galleggianti 3/8" <i>1/2" chromate brass tap for 3/8" filling valves</i>
1521-10	Set 10 tappini laterali <i>Set 10 side plugs</i>
1524A-10	Set 10 morsetti per vaso Ø esterno 55/60 Ø interno 40 <i>Set 10 bowl gaskets external Ø 55/60, internal Ø 40</i>
1531R3	Gruppo ponte con leve Concept 1 <i>Bridge with levers for Concept 1</i>
1532-10	Set 10 dadi per fissaggio meccanismo <i>Set 10 outlet valve nuts</i>
1533-10	Set 10 controdadi bianchi per fissaggio tubo Ø 50 <i>Set 10 fixing pipe back nuts Ø 50</i>
1535-10	Set 10 guarnizioni piane base meccanismo <i>Set 10 outlet valve flat gaskets</i>
1538-10	Set 10 guarnizioni coniche per tubo Ø 50 <i>Set 10 conical pipe gaskets Ø 50</i>
1540-10	Set 10 guarnizioni di tenuta meccanismo <i>Set 10 outlet valve gasket</i>
1560	Kit per fissaggio muro <i>Wall fixing kit</i>
PE	Pulsante esterno completo di tubetto e canalina <i>External push-button complete with pipe and tube</i>
PI	Pulsante incasso completo di tubetto e guaina <i>Built-in push-button complete with pipe and sheath</i>



Info packing

 Dimensioni imballo singolo <i>Single box dimensions</i>	48x14x41
 Peso imballo singolo <i>Weight single box</i>	2,74
 N° scatole singole su pallet <i>N° single box on a pallet</i>	60
 Dimensioni pallet <i>Pallet dimensions</i>	80x120x220
 N° scatole singole in cartone master <i>N° single box in a master box</i>	5
 Dimensioni cartone master <i>Master box dimensions</i>	72x48,5x43

CONCEPT 2

Doppio scarico - Double flush



Caratteristiche tecniche

- Installazione bassa a zaino o media posizione
- Scocca in ABS con trattamento anti invecchiamento
- Capacità 8 litri con possibilità di regolazione
- Omologazione 7 litri per normativa CE EN 14055
- Scarico parziale regolabile
- Coibentazione anticondensa ed insonorizzante
- Allacciamento idrico destro, sinistro o posteriore centrale
- Galleggiante 3/8" compatto, rapido e silenzioso
- Accessoriata di tubo

Technical features

- For low or medium level installation
- ABS body with anti-age treatment
- 8 liters capacity with the possibility to adjust the amount of water
- 7 liters homologation according to CE standard EN 14055
- Adjustable partial flush
- Anti-condensate and soundproofing insulation
- Water connection right, left or central back
- 3/8" compact filling valve, safe, quick and silent
- Equipped with pipe

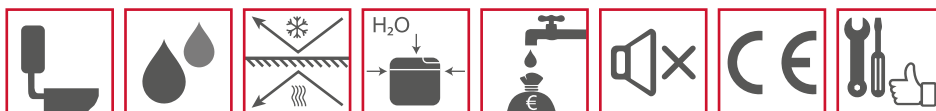

Art. / Item	Descrizione / Models	Colore / Colour		EAN
1000C2	CONCEPT 2 bianca doppio scarico, con rubinetto CONCEPT 2 double flush, with tap, white			8029954080014
1000C2CH	CONCEPT 2 champagne doppio scarico, con rubinetto CONCEPT 2 double flush, with tap, champagne			8029954000081
1000C2/07	CONCEPT 2 bianca doppio scarico, senza rubinetto CONCEPT 2 double flush, without tap, white			8029954010851

Equipaggiamento - Equipment



Galleggiante 3/8"
Rambo, codolo ottone
Filling valve Rambo,
with 3/8" brass tang



Meccanismo di
scarico
Flushing valve



Tubo di scarico
Outlet pipe



Isolamento
anti-condensa
Anti-condensation
insulation



Kit di fissaggio
Fixing kit

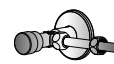

Rubinetto a squadra
Chromate tap

1000C2	✓	✓	✓	✓	✓	✓
1000C2CH	✓	✓	✓	✓	✓	✓
1000C2/07	✓	✓	✓	✓	✓	✓



PROFESSIONAL





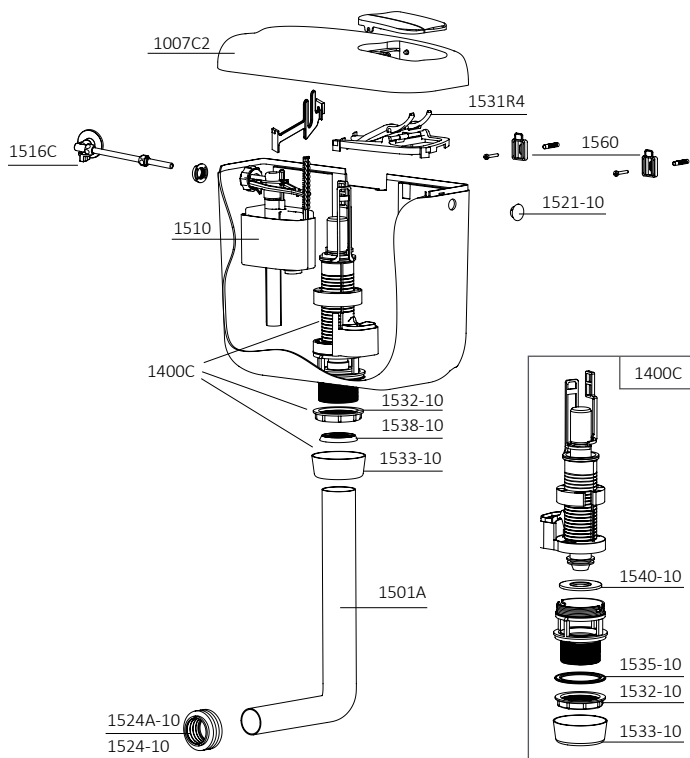

Line

Ricambi - Spare parts (Dettagli - Details pag. 56)

1007C2	Coperchio completo di pulsanti Cover complete with push buttons
1400C	Meccanismo di scarico con dado e controdado Outlet valve with nut and back nut
1501A	Tubo di scarico Ø 50x40 lunghezza mm 350x245 Pipe for wall low-level cistern Ø 50x40 mm 350x245
1510	Galleggiante Rambo 3/8" codolo ottone Rambo filling valve 3/8" brass tang
1516C	Rubinetto a squadra 1/2" ottone cromato per galleggianti 3/8" 1/2" chromate brass tap for 3/8" filling valves
1521-10	Set 10 tappini laterali Set 10 side plugs
1524A-10	Set 10 morsetti per vaso Ø esterno 55/60 Ø interno 40 Set 10 bowl gaskets external Ø 55/60, internal Ø 40
1524-10	Set 10 morsetti per vaso Ø esterno 55/60 Ø interno 32 Set 10 bowl gaskets external Ø 55/60, internal Ø 32
1531R4	Gruppo ponte con leve Concept 2 Bridge with levers for Concept 2
1532-10	Set 10 dadi per fissaggio meccanismo Set 10 outlet valve nuts
1533-10	Set 10 controdadi bianchi per fissaggio tubo Ø 50 Set 10 fixing pipe back nuts Ø 50
1535-10	Set 10 guarnizioni piane base meccanismo Set 10 outlet valve flat gaskets
1538-10	Set 10 guarnizioni coniche per tubo Ø 50 Set 10 conical pipe gaskets Ø 50
1540-10	Set 10 guarnizioni di tenuta meccanismo Set 10 outlet valve gasket
1560	Kit per fissaggio muro Wall fixing kit



Info packing

	Dimensioni imballo singolo Single box dimensions	48x14x41	
		Peso imballo singolo Weight single box	1000C2
			1000C2/07
	N° scatole singole su pallet N° single box on a pallet	60	
		Dimensioni pallet Pallet dimensions	80x120x220
		N° scatole singole in cartone master N° single box in a master box	5
		Dimensioni cartone master Master box dimensions	72x48,5x43

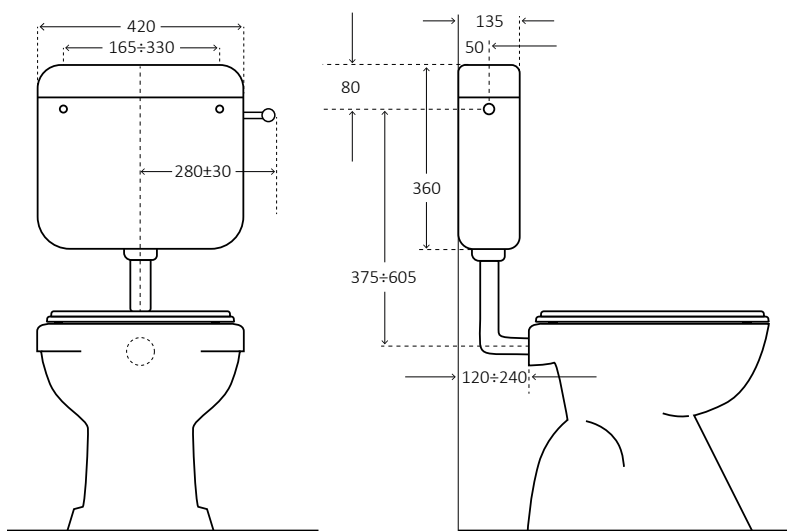

DELTA 1

Scarico singolo - Single flush



Caratteristiche tecniche

- Ultra-piatta
- Installazione bassa a zaino o media posizione
- Scocca in ABS con trattamento anti invecchiamento
- Capacità 8 litri con possibilità di regolazione
- Omologazione 7 litri per normativa CE EN 14055
- Tasto economizzatore d'acqua start/stop
- Coibentazione anticondensa ed insonorizzante
- Allacciamento idrico destro, sinistro o posteriore centrale
- Galleggiante 3/8" compatto, rapido e silenzioso
- Accessoriata di tubo

Technical features

- Super flat body
- For low or medium level installation
- ABS body with anti-age treatment
- 8 liters capacity with the possibility to adjust the amount of water
- 7 liters homologation for ce adjustment for CE standard EN 14055
- Single button with water-saving start/stop
- Anti-condensate and soundproofing insulation
- Water connection right, left or central back
- 3/8" compact filling valve, safe, quick and silent
- Equipped with pipe



Art. / Item	Descrizione / Models	EAN
1085	DELTA 1 bianca start/stop, senza rubinetto DELTA 1 start/stop system, without tap, white	8029954001095
1086	DELTA 1 bianca start/stop, con rubinetto DELTA 1 start/stop system, with tap, white	8029954001552

Equipaggiamento - Equipment



Galleggiante 3/8"
Rambo, codolo ottone
Filling valve Rambo, with
3/8" brass tang

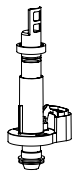

Meccanismo di
scarico
Flushing valve

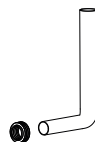

Tubo di scarico
Outlet pipe



Isolamento
anti-condensa
Anti-condensation
insulation

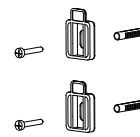

Kit di fissaggio
Fixing kit

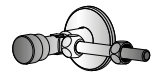

Rubinetto a squadra
Chromate tap

1085	✓	✓	✓	✓	✓	
1086	✓	✓	✓	✓	✓	✓



PROFESSIONAL

Line

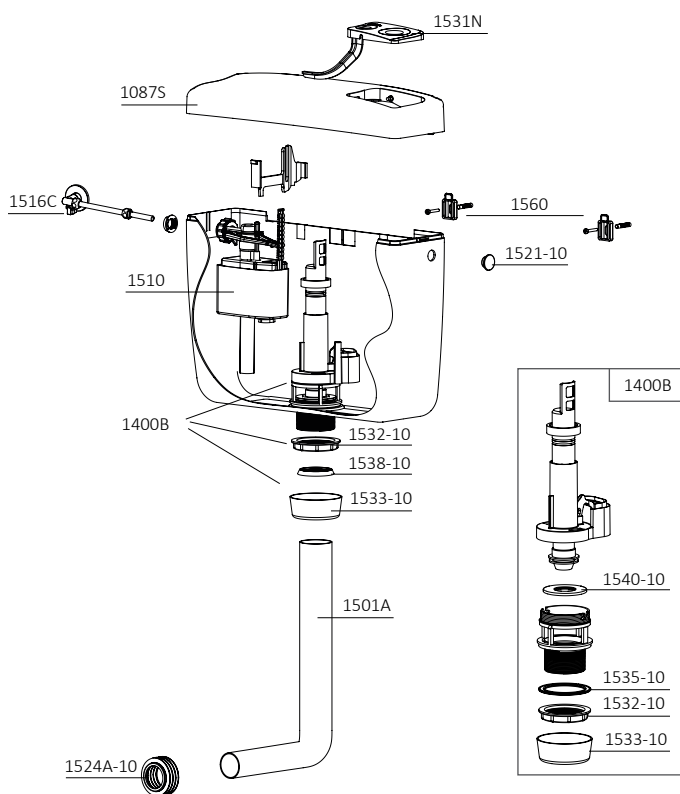





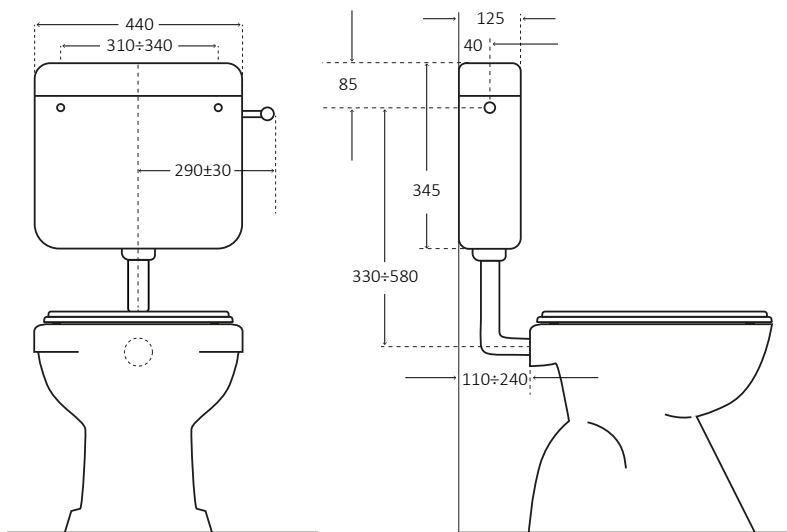

Ricambi - Spare parts (Dettagli - Details pag. 57)

1087S	Coperchio completo di pulsante Cover complete with push button
1400B	Meccanismo di scarico con dado e controdado Outlet valve with nut and back nut
1501A	Tubo di scarico Ø 50x40 lunghezza mm 350x245 Pipe for wall low-level cistern Ø 50x40 mm 350x245
1510	Galleggiante Rambo 3/8" codolo ottone Rambo filling valve 3/8" brass tang
1516C	Rubinetto a squadra 1/2" ottone cromato per galleggianti 3/8" 1/2" chromate brass tap for 3/8" filling valves
1521-10	Set 10 tappini laterali Set 10 side plugs
1524A-10	Set 10 morsetti per vaso Ø esterno 55/60 Ø interno 40 Set 10 bowl gasket external Ø 55/60, internal Ø 40
1531N	Tasto singolo con leva Single push button with lever
1532-10	Set 10 dadi per fissaggio meccanismo Set 10 outlet valve nuts
1533-10	Set 10 controdadi bianchi per fissaggio tubo Ø 50 Set 10 fixing pipe back nuts Ø 50
1535-10	Set 10 guarnizioni piane base meccanismo Set 10 outlet valve flat gaskets
1538-10	Set 10 guarnizioni coniche per tubo Ø 50 Set 10 conical pipe gaskets Ø 50
1540-10	Set 10 guarnizioni di tenuta meccanismo Set 10 outlet valve gasket
1560	Kit per fissaggio muro Wall fixing kit

Info packing



 Dimensioni imballo singolo Single box dimensions cm	44x13,5x38	
	 Peso imballo singolo Weight single box	1085
1086		2,34
 N° scatole singole su pallet N° single box on a pallet	85	
 Dimensioni pallet Pallet dimensions cm	80x120x236	
 N° scatole singole in cartone master N° single box in a master box	5	
 Dimensioni cartone master Master box dimensions cm	70x45x39	

DELTA 2

Doppio scarico - Double flush



Caratteristiche tecniche

- Ultra-piatta
- Installazione bassa a zaino o media posizione
- Scocca in ABS con trattamento anti invecchiamento
- Capacità 8 litri con possibilità di regolazione
- Omologazione 7 litri per normativa CE EN 14055
- Scarico parziale regolabile
- Coibentazione anticondensa ed insonorizzante
- Allacciamento idrico destro, sinistro o posteriore centrale
- Galleggiante 3/8" compatto, rapido e silenzioso
- Accessoriata di tubo

Technical features

- Super flat body
- For low or medium level installation
- ABS body with anti-age treatment
- 8 liters capacity with the possibility to adjust the amount of water
- 7 liters homologation according to CE standard EN 14055
- Adjustable partial flush
- Anti-condensate and soundproofing insulation
- Water connection right, left or central back
- 3/8" compact filling valve, safe, quick and silent
- Equipped with pipe

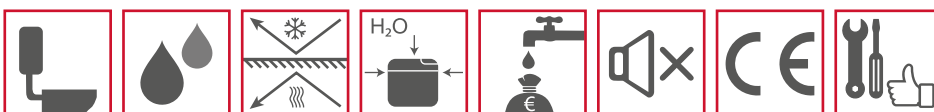

Art. / Item	Descrizione / Models	EAN
1083	DELTA 2 bianca doppio scarico, senza rubinetto DELTA 2 double flush system, without tap, white	8029954004782
1084	DELTA 2 bianca doppio scarico, con rubinetto DELTA 2 double flush system, with tap, white	8029954004805

Equipaggiamento - Equipment



Galleggiante 3/8"
Rambo, codolo ottone
Filling valve Rambo, with
3/8" brass tang

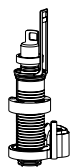

Meccanismo
di scarico
Flushing valve

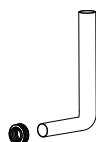

Tubo di scarico
Outlet pipe



Isolamento
anti-condensa
Anti-condensa-
tion insulation

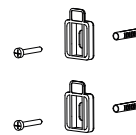

Kit di fissaggio
Fixing kit



Rubinetto a squadra
Chromate tap

1083	✓	✓	✓	✓	✓	
1084	✓	✓	✓	✓	✓	✓



PROFESSIONAL



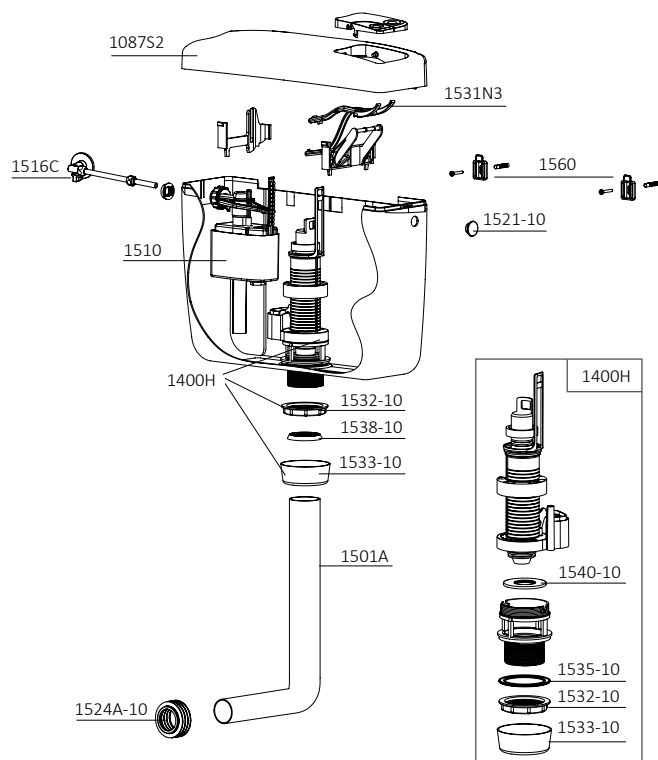



Line



Ricambi - Spare parts (Dettagli - Details pag. 57)

1087S2	Coperchio completo di pulsanti Cover complete with push buttons
1400H	Meccanismo di scarico con dado e controdado Outlet valve with nut and back nut
1501A	Tubo di scarico Ø 50x40 lunghezza mm 350x245 Pipe for wall low-level cistern Ø 50x40 mm 350x245
1510	Galleggiante Rambo 3/8" codolo ottone Rambo filling valve 3/8" brass tang
1516C	Rubinetto a squadra 1/2" ottone cromato per galleggianti 3/8" 1/2" chromate brass tap for 3/8" filling valves
1521-10	Set 10 tappini laterali Set 10 side plugs
1524A-10	Set 10 morsetti per vaso Ø esterno 55/60 Ø interno 40 Set 10 bowl gaskets external Ø 55/60, internal Ø 40
1531N3	Gruppo ponte con leve Delta 2 Bridge with levers for Delta 2
1532-10	Set 10 dadi per fissaggio meccanismo Set 10 outlet valve nuts
1533-10	Set 10 controdadi bianchi per fissaggio tubo Ø 50 Set 10 fixing pipe back nuts Ø 50
1535-10	Set 10 guarnizioni piane base meccanismo Set 10 outlet valve flat gaskets
1538-10	Set 10 guarnizioni coniche per tubo Ø 50 Set 10 conical pipe gaskets Ø 50
1540-10	Set 10 guarnizioni di tenuta meccanismo Set 10 outlet valve gasket
1560	Kit per fissaggio muro Wall fixing kit

Info packing

 Dimensioni imballo singolo Single box dimensions cm	44x13,5x38		
	 Peso imballo singolo Weight single box	1083	2,28
		1084	2,46
 N° scatole singole su pallet N° single box on a pallet	85		
 Dimensioni pallet Pallet dimensions cm	80x120x236		
 N° scatole singole in cartone master N° single box in a master box	5		
 Dimensioni cartone master Master box dimensions cm	70x45x39		

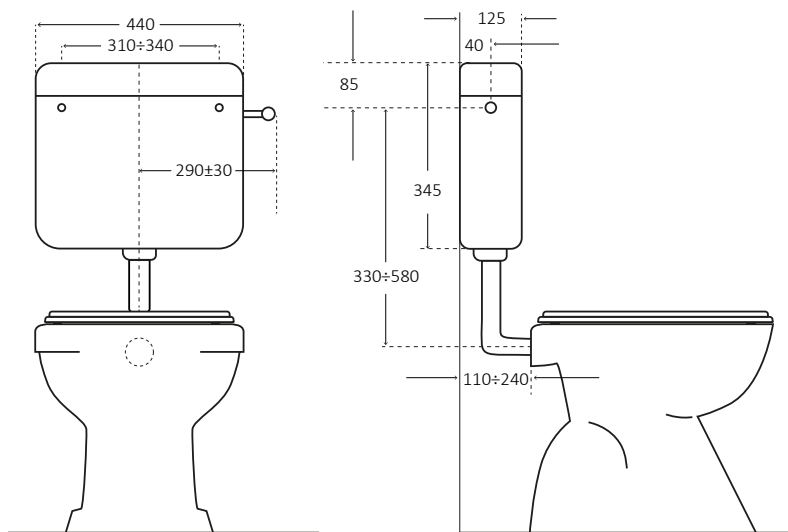

SFERA 1

Scarico singolo - Single flush



Caratteristiche tecniche

- Installazione bassa a zaino o media posizione
- Scocca in ABS con trattamento anti invecchiamento
- Capacità 8 litri con possibilità di regolazione
- Omologazione 7 litri per normativa CE EN 14055
- Tasto economizzatore d'acqua start/stop
- Coibentazione anticondensa ed insonorizzante
- Allacciamento idrico destro, sinistro o posteriore centrale
- Galleggiante 3/8" compatto, rapido e silenzioso
- Accessoriata di tubo

Technical features

- For low or medium level installation
- ABS body with anti-age treatment
- 8 liters capacity with the possibility to adjust the amount of water
- 7 liters homologation according to CE standard EN 14055
- Single button with water-saving start/stop
- Anti-condensate and soundproofing insulation
- Water connection right, left or central back
- 3/8" compact filling valve, safe, quick and silent
- Equipped with pipe



La linea di cassette wc "Sfera" può essere accessoriata con **PORTA-ROTOLO**, installabile lateralmente nel fusto della cassetta (vedi pag. 111)

"Sfera" wc cistern line can be equipped with **TOILET PAPER ROLL-HOLDER**, installable in the sides of the cisterns' body (see page 111)

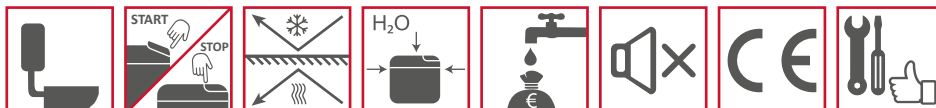

Art. / Item	Descrizione / Models	EAN
1000S1	SFERA 1 bianca start/stop, senza rubinetto SFERA 1 start/stop system, without tap, white	8029954000579
1001S1	SFERA 1 bianca start/stop, con rubinetto SFERA 1 start/stop system, with tap, white	8029954000593
1185N/01	Porta-rotolo cromato per cassette wc Toilet paper roll-holder for wc cisterns	8029954005260

Equipaggiamento - Equipment



Galleggiante 3/8" Rambo, codolo ottone
Filling valve Rambo, with 3/8" brass tang



Meccanismo di scarico
Flushing valve

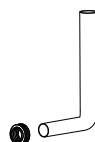

Tubo di scarico
Outlet pipe



Isolamento anti-condensa
Anti-condensation insulation

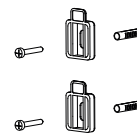

Kit di fissaggio
Fixing kit



Rubinetto a squadra
Chromate tap

1000S1	✓	✓	✓	✓	✓	
1001S1	✓	✓	✓	✓	✓	✓



PROFESSIONAL

Line

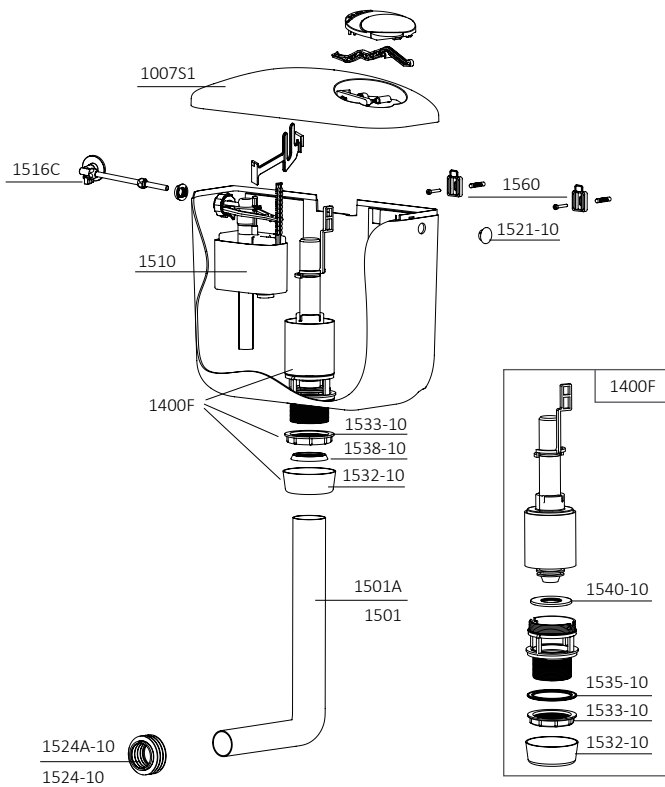





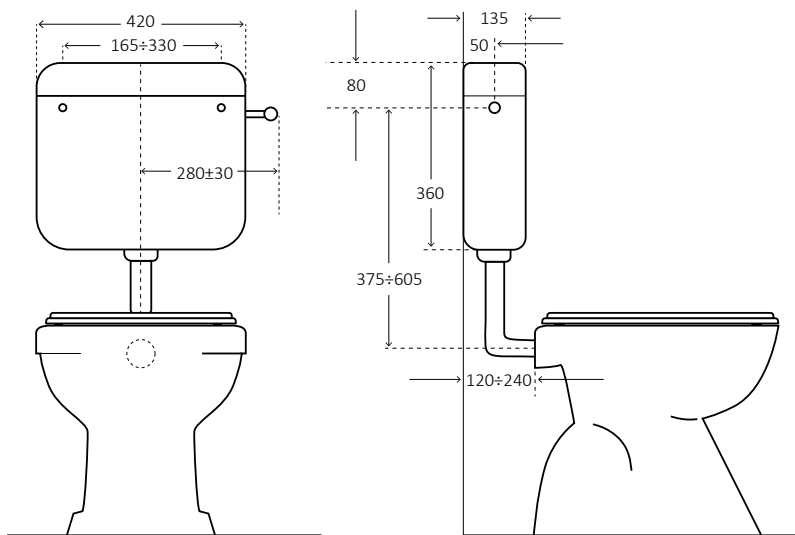

Ricambi - Spare parts (Dettagli - Details pag. 58)

1007S1	Coperchio completo di pulsante Cover complete with push button
1400F	Meccanismo di scarico con dado e controdado Outlet valve with nut and back nut
1501A	Tubo di scarico Ø 50x40 lunghezza mm 350x245 Pipe for wall low-level cistern Ø 50x40 mm 350x245
1501	Tubo di scarico Ø 50x32 lunghezza mm 346x225 Pipe for wall low-level cistern Ø 50x32 mm 346x225
1510	Galleggiante Rambo 3/8" codolo ottone Rambo filling valve 3/8" brass tang
1516C	Rubinetto a squadra 1/2" ottone cromato per galleggianti 3/8" 1/2" chromate brass tap for 3/8" filling valves
1521-10	Set 10 tappini laterali Set 10 side plugs
1524A-10	Set 10 morsetti per vaso Ø esterno 55/60 Ø interno 40 Set 10 bowl gaskets external Ø 55/60, internal Ø 40
1524-10	Set 10 morsetti per vaso Ø esterno 55/60 Ø interno 32 Set 10 bowl gaskets external Ø 55/60, internal Ø 32
1532-10	Set 10 dadi per fissaggio meccanismo Set 10 outlet valve nuts
1533-10	Set 10 controdadi bianchi per fissaggio tubo Ø 50 Set 10 fixing pipe back nuts Ø 50
1535-10	Set 10 guarnizioni piane base meccanismo Set 10 outlet valve flat gaskets
1538-10	Set 10 guarnizioni coniche per tubo Ø 50 Set 10 conical pipe gaskets Ø 50
1540-10	Set 10 guarnizioni di tenuta meccanismo Set 10 outlet valve gasket
1560	Kit per fissaggio muro Wall fixing kit

Info packing



 Dimensioni imballo singolo Single box dimensions cm	48x14x41	
	 Peso imballo singolo Weight single box	1000S1
1001S1		2,66
 N° scatole singole su pallet N° single box on a pallet	60	
 Dimensioni pallet Pallet dimensions cm	80x120x220	
 N° scatole singole in cartone master N° single box in a master box	5	
 Dimensioni cartone master Master box dimensions cm	72x48,5x43	

SFERA 2

Doppio scarico - Double flush



Caratteristiche tecniche

- Installazione bassa a zaino o media posizione
- Scocca in ABS con trattamento anti invecchiamento
- Capacità 8 litri con possibilità di regolazione
- Omologazione 7 litri per normativa CE EN 14055
- Scarico parziale regolabile
- Coibentazione anticondensa ed insonorizzante
- Allacciamento idrico destro, sinistro o posteriore centrale
- Galleggiante 3/8" compatto, rapido e silenzioso
- Accessoriata di tubo

Technical features

- For low or medium level installation
- ABS body with anti-age treatment
- 8 liters capacity with the possibility to adjust the amount of water
- 7 liters homologation according to CE standard EN 14055
- Partial flush adjustable
- Anti-condensate and soundproofing insulation
- Water connection right, left or central back
- 3/8" compact filling valve, safe, quick and silent
- Equipped with pipe

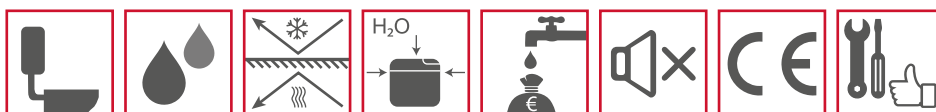

Art. / Item	Descrizione / Models	EAN
1000S2	SFERA 2 bianca a doppio scarico, senza rubinetto <i>SFERA 2 double flush system, without tap, white</i>	8029954000586
1001S2	SFERA 2 bianca a doppio scarico, con rubinetto <i>SFERA 2 double flush system, with tap, white</i>	8029954000609

Equipaggiamento - Equipment



Galleggiante 3/8"
Rambo, codolo ottone
*Filling valve Rambo, with
3/8" brass tang*

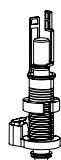

Meccanismo di
scarico
Flushing valve

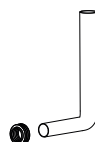

Tubo di scarico
Outlet pipe



Isolamento
anti-condensa
*Anti-condensa-
tion insulation*



Kit di fissaggio
Fixing kit



Rubinetto a squadra
Chromate tap

1000S2	✓	✓	✓	✓	✓	
1001S2	✓	✓	✓	✓	✓	✓



PROFESSIONAL

Line

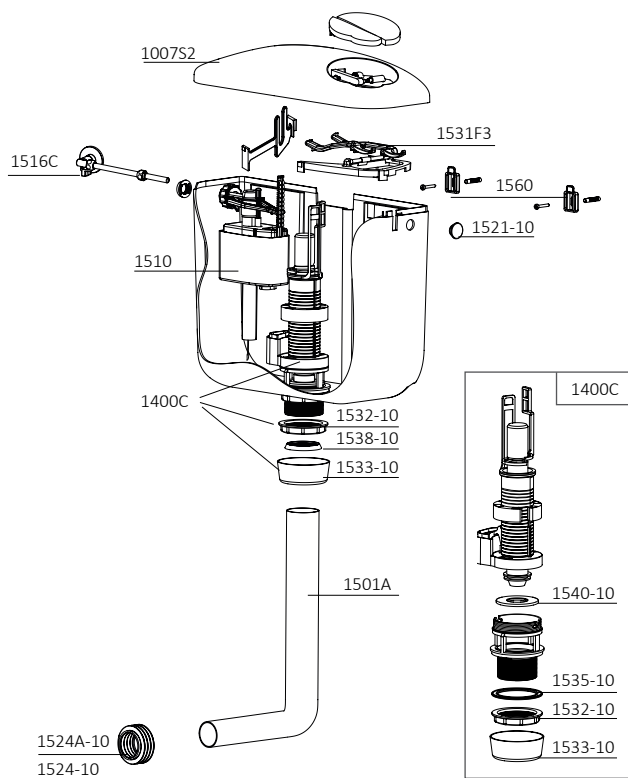





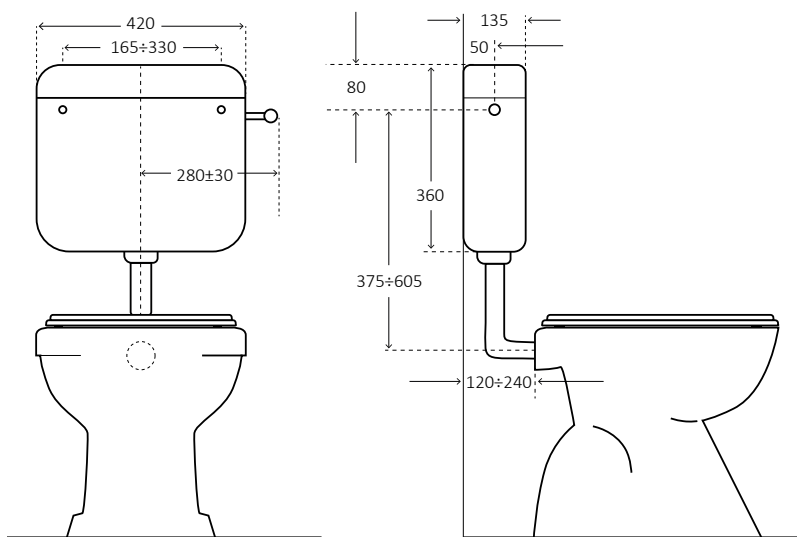

Ricambi - Spare parts (Dettagli - Details pag. 58)

1007S2	Coperchio completo di pulsanti Cover complete with push buttons
1400C	Meccanismo di scarico con dado e controdado Outlet valve with nut and back nut
1501A	Tubo di scarico Ø 50x40 lunghezza mm 350x245 Pipe for wall low-level cistern Ø 50x40 mm 350x245
1510	Galleggiante Rambo 3/8" codolo ottone Rambo filling valve 3/8" brass tang
1516C	Rubinetto a squadra 1/2" ottone cromato per galleggianti 3/8" 1/2" chromate brass tap for 3/8" filling valves
1521-10	Set 10 tappini laterali Set 10 side plugs
1524A-10	Set 10 morsetti per vaso Ø esterno 55/60 Ø interno 40 Set 10 bowl gaskets external Ø 55/60, internal Ø 40
1524-10	Set 10 morsetti per vaso Ø esterno 55/60 Ø interno 32 Set 10 bowl gaskets external Ø 55/60, internal Ø 32
1531F3	Gruppo ponte con leve Sfera 2 Bridge with levers for Sfera 2
1532-10	Set 10 dadi per fissaggio meccanismo Set 10 outlet valve nuts
1533-10	Set 10 controdadi bianchi per fissaggio tubo Ø 50 Set 10 fixing pipe back nuts Ø 50
1535-10	Set 10 guarnizioni piane base meccanismo Set 10 outlet valve flat gaskets
1538-10	Set 10 guarnizioni coniche per tubo Ø 50 Set 10 conical pipe gaskets Ø 50
1540-10	Set 10 guarnizioni di tenuta meccanismo Set 10 outlet valve gasket
1560	Kit per fissaggio muro Wall fixing kit

Info packing



 Dimensioni imballo singolo Single box dimensions cm	48x14x41	
	 Peso imballo singolo Weight single box	1000S2
1001S2		2,76
 N° scatole singole su pallet N° single box on a pallet	60	
 Dimensioni pallet Pallet dimensions cm	80x120x220	
 N° scatole singole in cartone master N° single box in a master box	5	
 Dimensioni cartone master Master box dimensions cm	72x48,5x43	

PLUS 1

Scarico singolo - Single flush



Caratteristiche tecniche

- Ultra-piatta
- Installazione bassa a zaino o media posizione
- Scocca in ABS con trattamento anti invecchiamento
- Capacità 8 litri con possibilità di regolazione
- Omologazione 7 litri per normativa CE EN 14055
- Tasto economizzatore d'acqua start/stop
- Coibentazione anticondensa ed insonorizzante
- Allacciamento idrico destro, sinistro o posteriore centrale
- Galleggiante 3/8" compatto, rapido e silenzioso
- Accessoriata di tubo

Technical features

- Super flat body
- For low or medium level installation
- ABS body with anti-age treatment
- 8 liters capacity with the possibility to adjust the amount of water
- 7 liters homologation according to CE standard EN 14055
- Single button with water-saving start/stop
- Anti-condensate and soundproofing insulation
- Water connection right, left or central back
- 3/8" compact filling valve, safe, quick and silent
- Equipped with pipe

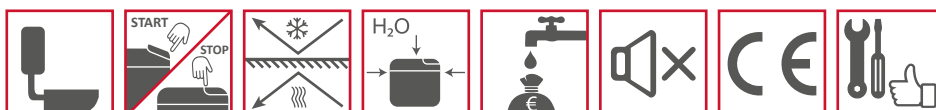

Art. / Item	Descrizione / Models	EAN
1030S	PLUS 1 bianca start/stop, senza rubinetto PLUS 1 start/stop system, without tap, white	8029954000241
1031S	PLUS 1 bianca start/stop, con rubinetto PLUS 1 start/stop system, with tap, white	8029954000388

Equipaggiamento - Equipment



Galleggiante 3/8"
Rambo, codolo ottone
Filling valve Rambo, with
3/8" brass tang

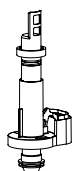

Meccanismo di
scarico
Flushing valve

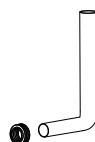

Tubo di scarico
Outlet pipe



Isolamento
anti-condensa
Anti-condensa-
tion insulation

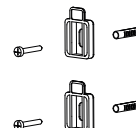

Kit di fissaggio
Fixing kit



Rubinetto a squadra
Chromate tap

1030S	✓	✓	✓	✓	✓	
1031S	✓	✓	✓	✓	✓	✓





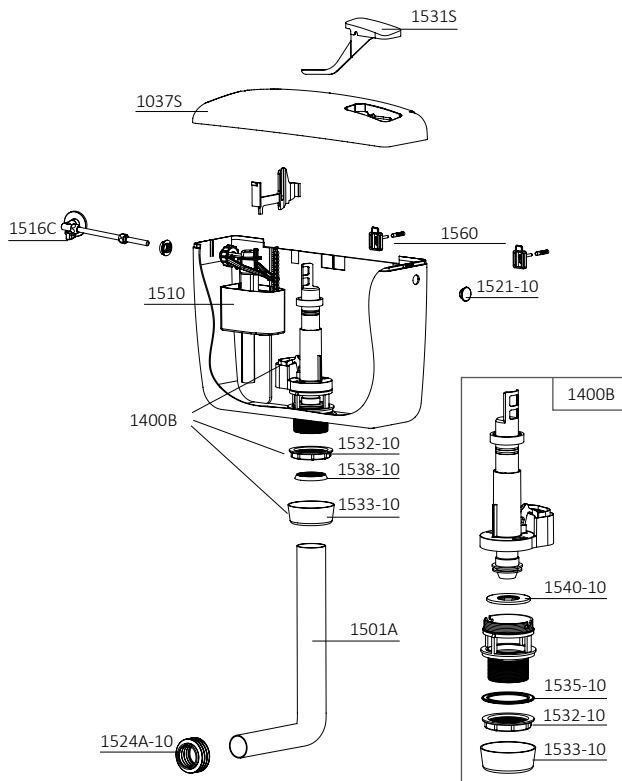



Ricambi - Spare parts (Dettagli - Details pag. 59)

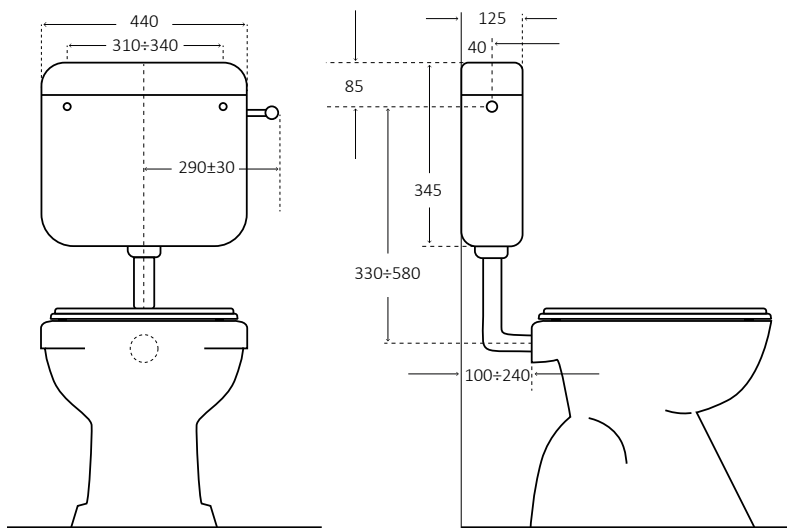

1037S	Coperchio completo di pulsante Cover complete with push button
1400B	Meccanismo di scarico con dado e controdado Outlet valve with nut and back nut
1501A	Tubo di scarico Ø 50x40 lunghezza mm 350x245 Pipe for wall low-level cistern Ø 50x40 mm 350x245
1510	Galleggiante Rambo 3/8" codolo ottone Rambo filling valve 3/8" brass tang
1516C	Rubinetto a squadra 1/2" ottone cromato per galleggianti 3/8" 1/2" chromate brass tap for 3/8" filling valves
1521-10	Set 10 tappini laterali Set 10 side plugs
1524A-10	Set 10 morsetti per vaso Ø esterno 55/60 Ø interno 40 Set 10 bowl gaskets external Ø 55/60, internal Ø 40
1531S	Pulsante Push-button
1532-10	Set 10 dadi per fissaggio meccanismo Set 10 outlet valve nuts
1533-10	Set 10 controdadi bianchi per fissaggio tubo Ø 50 Set 10 fixing pipe back nuts Ø 50
1535-10	Set 10 guarnizioni piane base meccanismo Set 10 outlet valve flat gaskets
1538-10	Set 10 guarnizioni coniche per tubo Ø 50 Set 10 conical pipe gaskets Ø 50
1540-10	Set 10 guarnizioni di tenuta meccanismo Set 10 outlet valve gasket
1560	Kit per fissaggio muro Wall fixing kit

Info packing



 Dimensioni imballo singolo Single box dimensions cm	44x13,5x38	
	 Peso imballo singolo Weight single box	1030S
1031S		2,38
 N° scatole singole su pallet N° single box on a pallet	85	
 Dimensioni pallet Pallet dimensions cm	80x120x236	
 N° scatole singole in cartone master N° single box in a master box	5	
 Dimensioni cartone master Master box dimensions cm	70x45x39	

PLUS 2

Doppio scarico - Double flush



Caratteristiche tecniche

- Ultra-piatta
- Installazione bassa a zaino o media posizione
- Scocca in ABS con trattamento anti invecchiamento
- Capacità 8 litri con possibilità di regolazione
- Omologazione 7 litri per normativa CE EN 14055
- Scarico parziale regolabile
- Coibentazione anticondensa ed insonorizzante
- Allacciamento idrico destro, sinistro o posteriore centrale
- Galleggiante 3/8" compatto, rapido e silenzioso
- Accessoriata di tubo

Technical features

- Super flat body
- For low or medium level installation
- ABS body with anti-age treatment
- 8 liters capacity with the possibility to adjust the amount of water
- 7 liters homologation according to CE standard EN 14055
- Partial flush adjustable
- Anti-condensate and soundproofing insulation
- Water connection right, left or central back
- 3/8" compact filling valve, safe, quick and silent
- Equipped with pipe

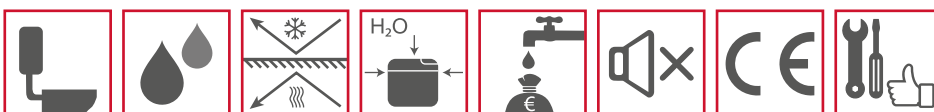

Art. / Item	Descrizione / Models	EAN
1030S2	PLUS 2 bianca doppio scarico, senza rubinetto PLUS 2 double flush system, without tap, white	8029954000968
1031S2	PLUS 2 bianca doppio scarico, con rubinetto PLUS 2 double flush system, with tap, white	8029954000975

Equipaggiamento - Equipment



Galleggiante 3/8"
Rambo, codolo ottone
Filling valve Rambo, with
3/8" brass tang

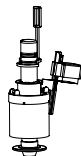

Meccanismo di
scarico
Flushing valve

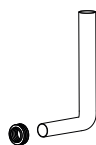

Tubo di scarico
Outlet pipe



Isolamento
anti-condensa
Anti-condensa-
tion insulation

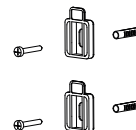

Kit di fissaggio
Fixing kit



Rubinetto a squadra
Chromate tap

1030S2	✓	✓	✓	✓	✓	
1031S2	✓	✓	✓	✓	✓	✓





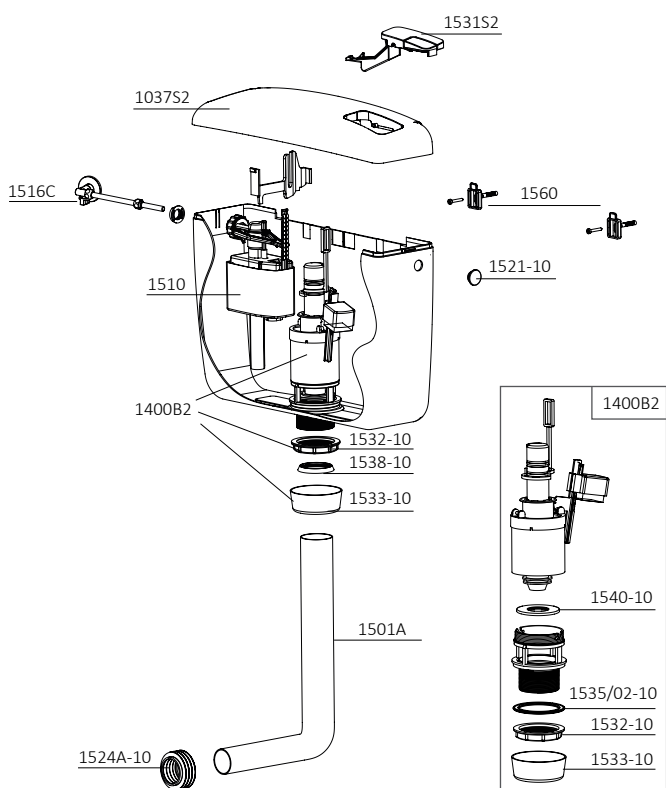



Ricambi - Spare parts (Dettagli - Details pag. 59)

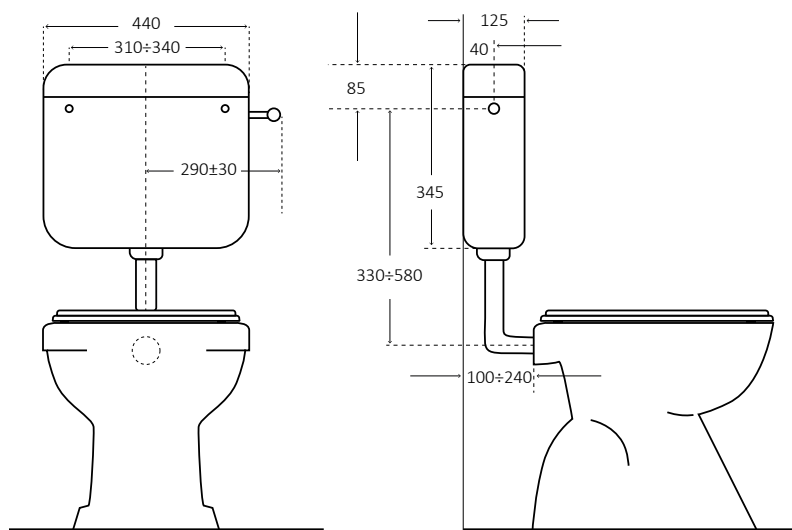

1037S2	Coperchio completo di pulsanti <i>Cover complete with push buttons</i>
1400B2	Meccanismo di scarico con dado e controdado <i>Outlet valve with nut and back nut</i>
1501A	Tubo di scarico Ø 50x40 lunghezza mm 350x245 <i>Pipe for wall low-level cistern Ø 50x40 mm 350x245</i>
1510	Galleggiante Rambo 3/8" codolo ottone <i>Rambo filling valve 3/8" brass tang</i>
1516C	Rubinetto a squadra 1/2" ottone cromato per galleggianti 3/8" <i>1/2" chromate brass tap for 3/8" filling valves</i>
1521-10	Set 10 tappini laterali <i>Set 10 side plugs</i>
1524A-10	Set 10 morsetti per vaso Ø esterno 55/60 Ø interno 40 <i>Set 10 bowl gaskets external Ø 55/60, internal Ø 40</i>
1531S2	Doppio pulsante <i>Double push-button</i>
1532-10	Set 10 dadi per fissaggio meccanismo <i>Set 10 outlet valve nuts</i>
1533-10	Set 10 controdadi bianchi per fissaggio tubo Ø 50 <i>Set 10 fixing pipe back nuts Ø 50</i>
1535/02-10	Set 10 guarnizioni piane base meccanismo <i>Set 10 outlet valve flat gaskets</i>
1538-10	Set 10 guarnizioni coniche per tubo Ø 50 <i>Set 10 conical pipe gaskets Ø 50</i>
1540-10	Set 10 guarnizioni di tenuta meccanismo <i>Set 10 outlet valve gasket</i>
1560	Kit per fissaggio muro <i>Wall fixing kit</i>

Info packing



	Dimensioni imballo singolo <i>Single box dimensions</i>	44x13,5x38	
		Peso imballo singolo <i>Weight single box</i>	1030S2
			1031S2
	N° scatole singole su pallet <i>N° single box on a pallet</i>	85	
	Dimensioni pallet <i>Pallet dimensions</i>	80x120x236	
	N° scatole singole in cartone master <i>N° single box in a master box</i>	5	
	Dimensioni cartone master <i>Master box dimensions</i>	70x45x39	

SMART

Scarico singolo - Single flush



Caratteristiche tecniche

- Ultra piatta
- Installazione bassa a zaino o media posizione
- Scocca in ABS con trattamento anti invecchiamento
- Capacità 8 litri con possibilità di regolazione
- Omologazione 7 litri per normativa CE EN 14055
- Tasto economizzatore d'acqua start/stop
- Coibentazione anticondensa ed insonorizzante
- Allacciamento idrico destro, sinistro o posteriore centrale
- Galleggiante 3/8" compatto, rapido e silenzioso
- Accessoriata di tubo

Technical features

- Super flat body
- For low or medium level installation
- ABS body with anti-age treatment
- 8 liters capacity with the possibility to adjust the amount of water
- 7 liters homologation according to CE standard EN 14055
- Single button with water-saving start/stop
- Anti-condensate and soundproofing insulation
- Water connection right, left or central back
- 3/8" compact filling valve, safe, quick and silent
- Equipped with pipe



Art. / Item	Descrizione / Models	EAN
1080	SMART bianca start/stop, senza rubinetto SMART start/stop system, without tap, white	8029954001026
1081	SMART bianca start/stop, con rubinetto SMART start/stop system, with tap, white	8029954001033

Equipaggiamento - Equipment



Galleggiante 3/8"
Rambo, codolo ottone
Filling valve Rambo, with
3/8" brass tang

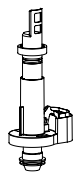

Meccanismo di
scarico
Flushing valve



Tubo di scarico
Outlet pipe



Isolamento
anti-condensa
Anti-condensa-
tion insulation

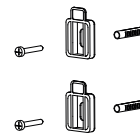

Kit di fissaggio
Fixing kit

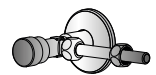

Rubinetto a squadra
Chromate tap

1080	✓	✓	✓	✓	✓	
1081	✓	✓	✓	✓	✓	✓





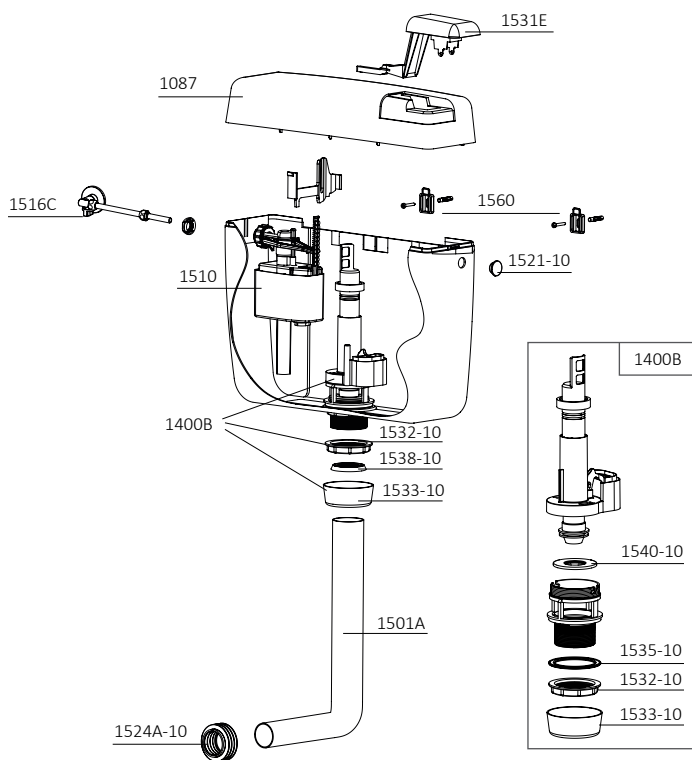



Ricambi - Spare parts (Dettagli - Details pag. 60)

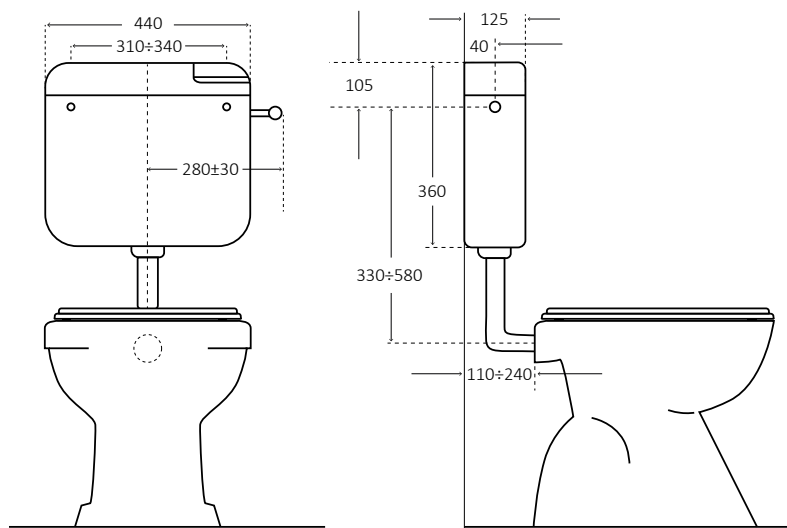

1087	Coperchio completo di pulsante <i>Cover complete with push button</i>
1400B	Meccanismo di scarico con dado e controdado <i>Outlet valve with nut and back nut</i>
1501A	Tubo di scarico Ø 50x40 lunghezza mm 350x245 <i>Pipe for wall low-level cistern Ø 50x40 mm 350x245</i>
1510	Galleggiante Rambo 3/8" codolo ottone <i>Rambo filling valve 3/8" brass tang</i>
1516C	Rubinetto a squadra 1/2" ottone cromato per galleggianti 3/8" <i>1/2" chromate brass tap for 3/8" filling valves</i>
1521-10	Set 10 tappini laterali <i>Set 10 side plugs</i>
1524A-10	Set 10 morsetti per vaso Ø esterno 55/60 Ø interno 40 <i>Set 10 bowl gaskets external Ø 55/60, internal Ø 40</i>
1531E	Pulsante <i>Push-button</i>
1532-10	Set 10 dadi per fissaggio meccanismo <i>Set 10 outlet valve nuts</i>
1533-10	Set 10 controdadi bianchi per fissaggio tubo Ø 50 <i>Set 10 fixing pipe back nuts Ø 50</i>
1535-10	Set 10 guarnizioni piane base meccanismo <i>Set 10 outlet valve flat gaskets</i>
1538-10	Set 10 guarnizioni coniche per tubo Ø 50 <i>Set 10 conical pipe gaskets Ø 50</i>
1540-10	Set 10 guarnizioni di tenuta meccanismo <i>Set 10 outlet valve gasket</i>
1560	Kit per fissaggio muro <i>Wall fixing kit</i>

Info packing



 Dimensioni imballo singolo <i>Single box dimensions</i>	44x13,5x40	
 Peso imballo singolo <i>Weight single box</i>	1080	2,14
	1081	2,32
 N° scatole singole su pallet <i>N° single box on a pallet</i>	80	
 Dimensioni pallet <i>Pallet dimensions</i>	80x120x236	
 N° scatole singole in cartone master <i>N° single box in a master box</i>	5	
 Dimensioni cartone master <i>Master box dimensions</i>	70x45x41	

BETA

Scarico singolo - Single flush



Caratteristiche tecniche

- Ultra piatta
- Installazione bassa a zaino o media posizione
- Scocca in ABS con trattamento anti invecchiamento
- Capacità 8 litri con possibilità di regolazione
- Tasto economizzatore d'acqua start/stop
- Allacciamento idrico destro o sinistro
- Galleggiante 3/8" compatto, rapido e silenzioso
- Accessoriata di tubo

Technical features

- Super flat body
- For low or medium level installation
- ABS body with anti-age treatment
- 8 liters capacity with the possibility to adjust the amount of water
- Single button with water-saving start/stop
- Water connection right or left
- 3/8" compact filling valve, safe, quick and silent
- Equipped with pipe

Beta®



DOWNLOAD

Vedi scheda tecnica
View technical sheet

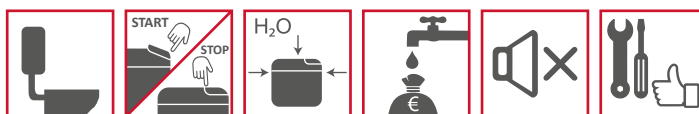

Art. / Item	Descrizione / Models	Colore / Colour	EAN
1030	BETA bianca start/stop, senza rubinetto BETA start/stop system, without tap, white		8029954000265
1030CH	BETA champagne start/stop, senza rubinetto BETA start/stop system, without tap, champagne		8029954000302

Equipaggiamento - Equipment



Galleggiante 3/8"
Rambo, codolo ottone
Filling valve Rambo, with
3/8" brass tang

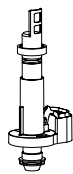

Meccanismo di
scarico
Flushing valve



Tubo di scarico
Outlet pipe

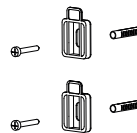

Kit di fissaggio
Fixing kit



Rubinetto a squadra
Chromate tap

1030	✓	✓	✓	✓
1030CH	✓	✓	✓	✓





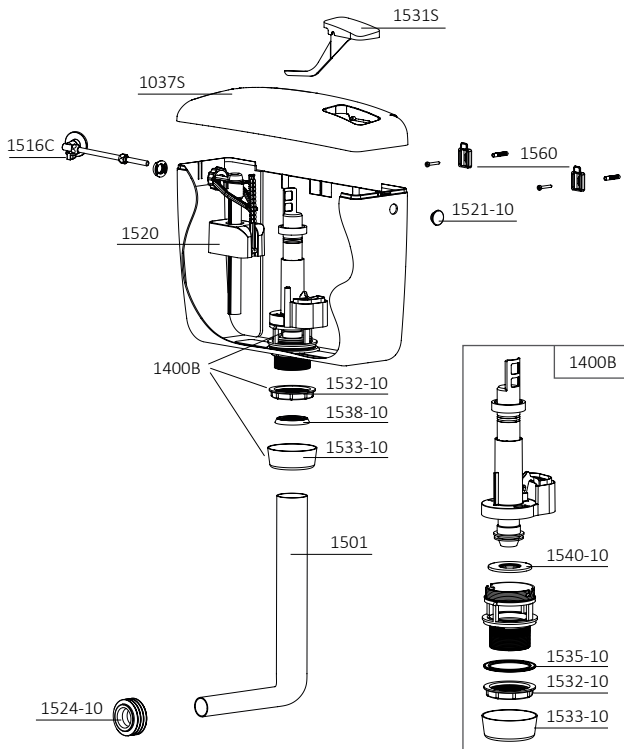



Ricambi - Spare parts (Dettagli - Details pag. 60)

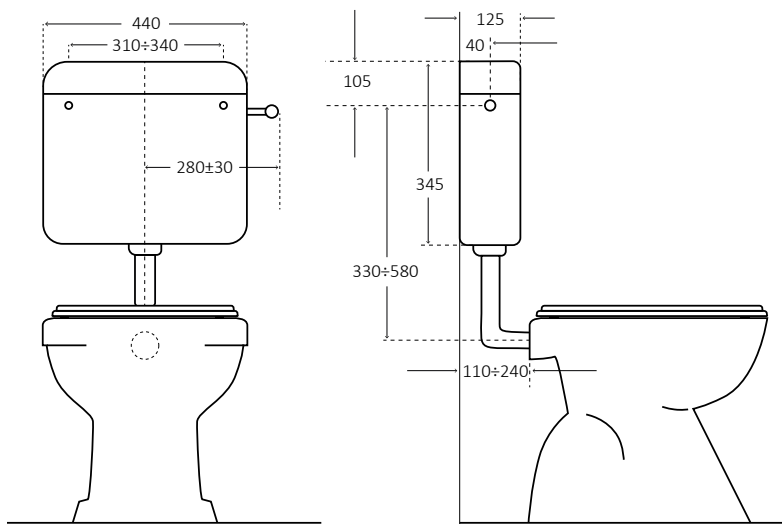

10375	Coperchio completo di pulsante Cover complete with push button
1400B	Meccanismo di scarico con dado e controdado Outlet valve with nut and back nut
1501	Tubo di scarico Ø 50x32 lunghezza mm 346x225 Pipe for wall low-level cistern Ø 50x32 mm 346x225
1520	Galleggiante Blue 3/8" codolo ottone Blue filling valve 3/8" brass tang
1516C	Rubinetto a squadra 1/2" ottone cromato per galleggianti 3/8" 1/2" chromate brass tap for 3/8" filling valves
1521-10	Set 10 tappini laterali Set 10 side plugs
1524-10	Set 10 morsetti per vaso Ø esterno 55/60 Ø interno 32 Set 10 bowl gaskets external Ø 55/60, internal Ø 32
15315	Pulsante Push-button
1532-10	Set 10 dadi per fissaggio meccanismo Set 10 outlet valve nuts
1533-10	Set 10 controdadi bianchi per fissaggio tubo Ø 50 Set 10 fixing pipe back nuts Ø 50
1535-10	Set 10 guarnizioni piane base meccanismo Set 10 outlet valve flat gaskets
1538-10	Set 10 guarnizioni coniche per tubo Ø 50 Set 10 conical pipe gaskets Ø 50
1540-10	Set 10 guarnizioni di tenuta meccanismo Set 10 outlet valve gasket
1560	Kit per fissaggio muro Wall fixing kit

Info packing



 Dimensioni imballo singolo Single box dimensions	44x13,5x38
 Peso imballo singolo Weight single box	2,04
 N° scatole singole su pallet N° single box on a pallet	85
 Dimensioni pallet Pallet dimensions	80x120x236
 N° scatole singole in cartone master N° single box in a master box	5
 Dimensioni cartone master Master box dimensions	70x45x39

EXPORT

Scarico singolo - Single flush



Caratteristiche tecniche

- Ultra piatta
- Installazione bassa a zaino o media posizione
- Scocca in ABS con trattamento anti invecchiamento
- Capacità 8 litri con possibilità di regolazione
- Tasto economizzatore d'acqua start/stop
- Allacciamento idrico destro o sinistro
- Galleggiante 3/8" compatto, rapido e silenzioso
- Accessoriata di tubo

Technical features

- Super flat body
- For low or medium level installation
- ABS body with anti-age treatment
- 8 liters capacity with the possibility to adjust the amount of water
- Single button with water-saving start/stop
- Water connection right or left
- 3/8" compact filling valve, safe, quick and silent
- Equipped with pipe



DOWNLOAD

Vedi scheda tecnica
View technical sheet



Art. / Item	Descrizione / Models	EAN
1034	EXPORT bianca start/stop, senza rubinetto EXPORT start/stop system, without tap, white	8029954000340

Equipaggiamento - Equipment



Galleggiante 3/8"
Blue, codolo plastica
Filling valve Blue,
with 3/8" pom tang

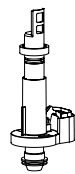

Meccanismo di
scarico
Flushing valve



Tubo di scarico
Outlet pipe

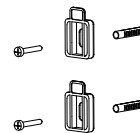

Kit di fissaggio
Fixing kit

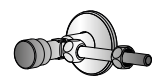

Rubinetto a squadra
Chromate tap

1034	✓	✓	✓	✓
------	---	---	---	---





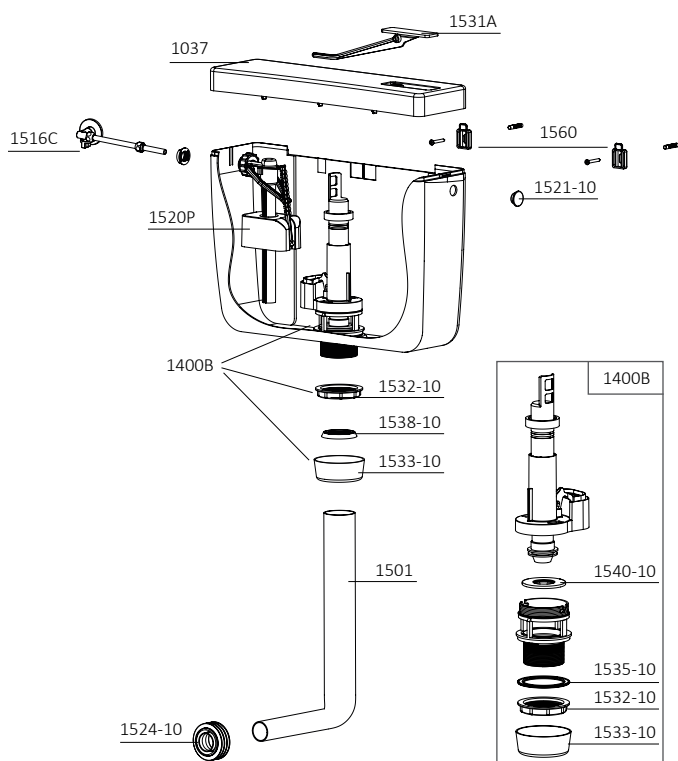

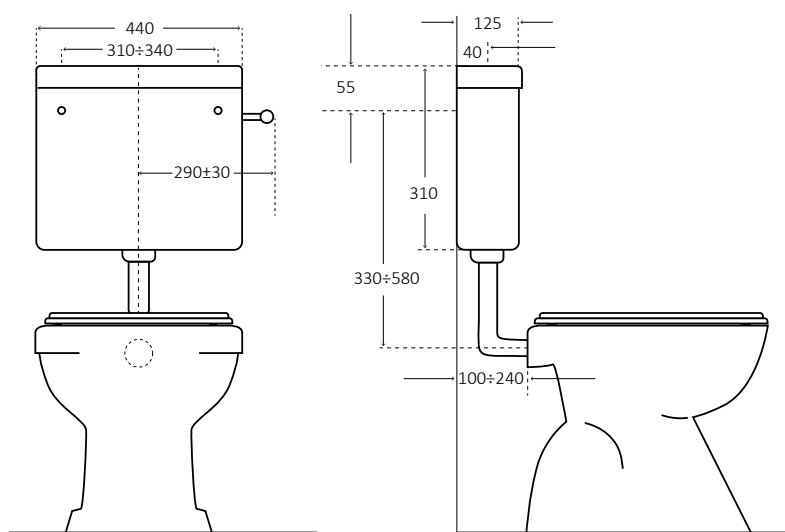

Ricambi - Spare parts (Dettagli - Details pag. 61)



1037	Coperchio completo di pulsante Cover complete with push button
1400B	Meccanismo di scarico con dado e controdado Outlet valve with nut and back nut
1501	Tubo di scarico Ø 50x32 lunghezza mm 346x225 Pipe for wall low-level cistern Ø 50x32 mm 346x225
1516C	Rubinetto a squadra 1/2" ottone cromato per galleggianti 3/8" 1/2" chromate brass tap for 3/8" filling valves
1520P	Galleggiante Blue 3/8" codolo plastica Blue filling valve 3/8" pom tang
1521-10	Set 10 tappini laterali Set 10 side plugs
1524-10	Set 10 morsetti per vaso Ø esterno 55/60 Ø interno 32 Set 10 bowl gaskets external Ø 55/60, internal Ø 32
1531A	Pulsante Push-button
1532-10	Set 10 dadi per fissaggio meccanismo Set 10 outlet valve nuts
1533-10	Set 10 controdadi bianchi per fissaggio tubo Ø 50 Set 10 fixing pipe back nuts Ø 50
1535-10	Set 10 guarnizioni piane base meccanismo Set 10 outlet valve flat gaskets
1538-10	Set 10 guarnizioni coniche per tubo Ø 50 Set 10 conical pipe gaskets Ø 50
1540-10	Set 10 guarnizioni di tenuta meccanismo Set 10 outlet valve gasket
1560	Kit per fissaggio muro Wall fixing kit



Info packing

 Dimensioni imballo singolo Single box dimensions	44x13,5x35
 Peso imballo singolo Weight single box	2,00
 N° scatole singole su pallet N° single box on a pallet	90
 Dimensioni pallet Pallet dimensions	80x120x236
 N° scatole singole in cartone master N° single box in a master box	5
 Dimensioni cartone master Master box dimensions	70x45x36

LEGENDA



Installazione in posizione alta
High level installation



Installazione in posizione monoblocco
Monoblock installation



Tasto economizzatore d'acqua start/stop
Single button with water-saving start/stop



Doppio scarico
Double flush



Scarico singolo
Single flush



Possibilità di azionamento da remoto
Possibility to remote functioning



Isolamento anti-condensa ed insonorizzante
Anti-condensate and soundproofing insulation



Attacco idrico destro, sinistro
e posteriore centrale
*Water connection right, left
and central back*

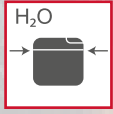

Attacco idrico destro o sinistro
Water connection right or left



Risparmio acqua
Water saving



Funzionamento silenzioso
Silent functioning



Conforme alla normativa CE EN 14055
Comply to CE standard EN 14055



Montaggio semplice e veloce
Easy and fast mounting

CASSETTE SPECIALI SPECIAL WC CISTERNS

La linea di cassette speciali CR: know-how, ricerca e perfezionamento tecnico a disposizione delle tue esigenze di installazione

The range of CR special wc cisterns : know-how, research and technical improvement available for your installation needs



Concept
Monoblock

Pneumatic
button



CONCEPT PNEU

Pulsante pneumatico - Pneumatic flush



Caratteristiche tecniche

- Installazione bassa a zaino o media posizione
- Scocca in ABS con trattamento anti invecchiamento
- Funzionamento ibrido sia con PE/PI che con pulsante a coperchio
- Capacità 8 litri con possibilità di regolazione
- Omologazione 7 litri per normativa CE EN 14055
- Tasto economizzatore d'acqua start/stop
- Coibentazione anticondensa ed insonorizzante
- Allacciamento idrico destro, sinistro o posteriore centrale
- Galleggiante 3/8" compatto, rapido e silenzioso
- Accessoriata di tubo
- Completa di riduzione per eventuale collegamento a tubi ø32
- Completa di pulsante pneumatico

Technical features

- For low or medium level installation
- ABS body with anti-age treatment
- Hybrid functioning both with PE/PI and with push button on the cover
- 8 liters capacity with the possibility to adjust the amount of water
- 7 liters homologation according to CE standard EN 14055
- Single button with water-saving start/stop
- Anti-condensate and soundproofing insulation
- Water connection right, left or central back
- 3/8" compact filling valve, safe, quick and silent
- Equipped with pipe
- Equipped with reduction ø32 for connection to high level pipes
- Equipped with pneumatic push-button

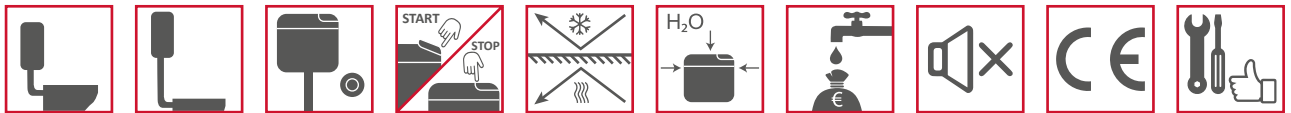

Art. / Item	Descrizione / Models	EAN
1000C1PE	CONCEPT 1 bianca start/stop, con pulsante pneumatico esterno, con rubinetto CONCEPT 1 start/stop system, with external push-button, with tap, white	8029954080045
1000C1PI	CONCEPT 1 bianca start/stop, con pulsante pneumatico a incasso, con rubinetto CONCEPT 1 start/stop system, with built-in push-button, with tap, white	8029954080052

Equipaggiamento - Equipment

	Galleggiante 3/8" Rambo, codolo ottone Filling valve Rambo, with 3/8" brass tang	Meccanismo di scarico e riduzione ø32 Flushing valve and reduction ø32	Tubo di scarico Outlet pipe	Isolamento anti-condensa Anti-condensation insulation	Kit di fissaggio Fixing kit	Rubinetto a squadra Chromate tap	Pulsante pneu e tubetto 300 cm Pneu push-button and pipe 300 cm	Canalina rigida e fissaggi / Guaina da incasso Fixing kit with rigid tube / Sheath
1000C1PE	✓	✓	✓	✓	✓	✓	✓	✓
1000C1PI	✓	✓	✓	✓	✓	✓	✓	✓



PROFESSIONAL

Line

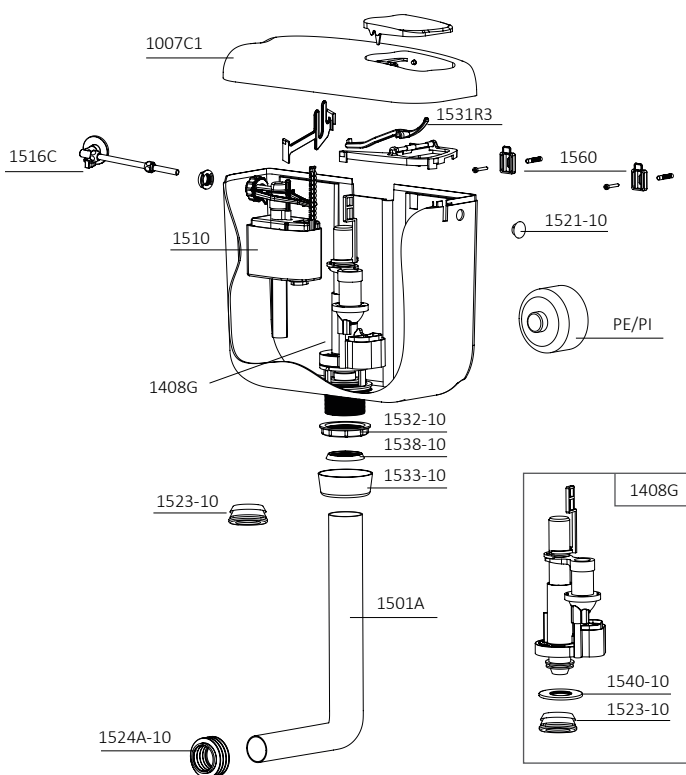





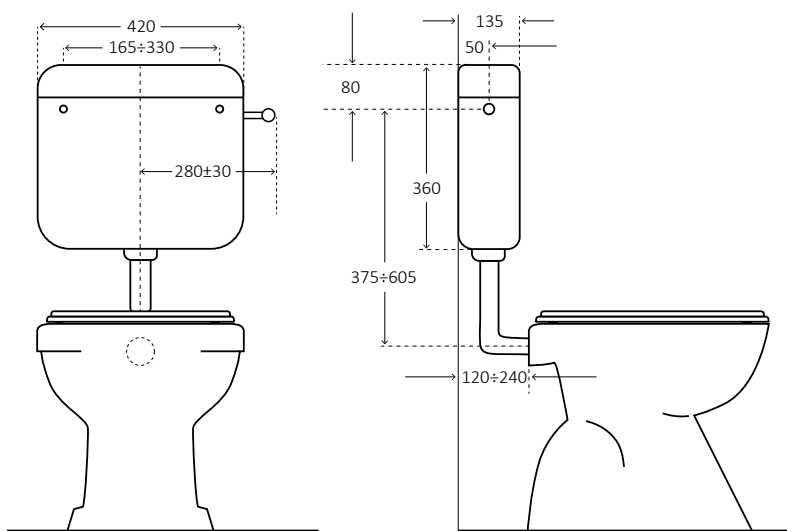

Ricambi - Spare parts (Dettagli - Details pag. 62)

1007C1	Coperchio completo di pulsante Cover complete with push button
1408G	Meccanismo di scarico pneu con dado e controdado Pneumatic outlet valve with nut and back nut
1501A	Tubo di scarico Ø 50x40 lunghezza mm 350x245 Pipe for wall low-level cistern Ø 50x40 mm 350x245
1510	Galleggiante Rambo 3/8" codolo ottone Rambo filling valve 3/8" brass tang
1516C	Rubinetto a squadra 1/2" ottone cromato per galleggianti 3/8" 1/2" chromate brass tap for 3/8" filling valves
1521-10	Set 10 tappini laterali Set 10 side plugs
1523-10	Set 10 morsetti per vaso Ø esterno 48/50 Ø interno 32 Set 10 bowl gaskets external Ø 48/50, internal Ø 32
1524A-10	Set 10 morsetti per vaso Ø esterno 55/60 Ø interno 40 Set 10 bowl gaskets external Ø 55/60, internal Ø 40
1531R3	Gruppo ponte con leve Concept 1 Bridge with levers for Concept 1
1532-10	Set 10 dadi per fissaggio meccanismo Set 10 outlet valve nuts
1533-10	Set 10 controdadi bianchi per fissaggio tubo Ø 50 Set 10 fixing pipe back nuts Ø 50
1535-10	Set 10 guarnizioni piane base meccanismo Set 10 outlet valve flat gaskets
1538-10	Set 10 guarnizioni coniche per tubo Ø 50 Set 10 conical pipe gaskets Ø 50
1540-10	Set 10 guarnizioni di tenuta meccanismo Set 10 outlet valve gasket
1560	Kit per fissaggio muro Wall fixing kit
PE	Pulsante esterno completo di tubetto e canalina External push-button complete with pipe and tube
PI	Pulsante incasso completo di tubetto e guaina Built-in push-button complete with pipe and sheath

Info packing



 Dimensioni imballo singolo Single box dimensions cm			48x14x41
	 Peso imballo singolo Weight single box	1000C1PE	3,10
1000C1PI		3,12	
 N° scatole singole su pallet N° single box on a pallet			60
	 Dimensioni pallet Pallet dimensions cm		
 N° scatole singole in cartone master N° single box in a master box			
	 Dimensioni cartone master Master box dimensions cm		

CONCEPT MONOBLOCK 1

Scarico singolo - Single flush



Caratteristiche tecniche

- Installazione in posizione monoblocco
- Scocca in ABS con trattamento anti invecchiamento
- Capacità 8 litri con possibilità di regolazione
- Omologazione 7 litri per normativa CE EN 14055
- Tasto economizzatore d'acqua start/stop
- Coibentazione anticondensa ed insonorizzante
- Allacciamento idrico destro, sinistro o posteriore centrale
- Galleggiante 3/8" compatto, rapido e silenzioso

Technical features

- For monoblock installation
- ABS body with anti-age treatment
- 8 liters capacity with the possibility to adjust the amount of water
- 7 liters homologation according to CE standard EN 14055
- Single button with water-saving start/stop
- Anti-condensate and soundproofing insulation
- Water connection right, left or central back
- 3/8" compact filling valve, safe, quick and silent

Adatta anche alla sostituzione di cassette in porcellana pre-esistenti

Also suitable for the replacement of the pre-existing vitreous china cisterns

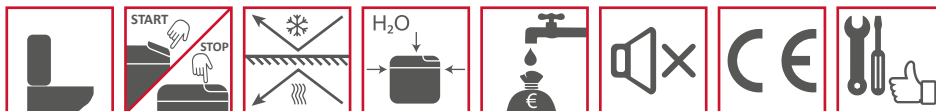

Art. / Item

Descrizione / Models

EAN

1000MC1

CONCEPT MONOBLOCK 1 bianca start/stop, senza rubinetto
CONCEPT MONOBLOCK 1 start/stop system, without tap, white

8029954080021

Equipaggiamento - Equipment



Galleggiante 3/8"
Rambo, codolo ottone
Filling valve Rambo,
with 3/8" brass tang

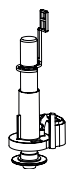

Meccanismo di scarico
Flushing valve



Piastra monoblocco
attacco universale
Monoblock base
universal fixing

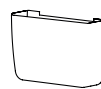

Isolamento
anti-condensa
Anti-condensation
insulation

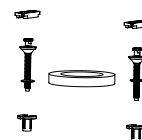

Kit di fissaggio per
vaso monoblocco
Fixing kit for
monoblock bowl

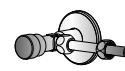

Rubinetto a squadra
Chromate tap

1000MC1





PROFESSIONAL

Line

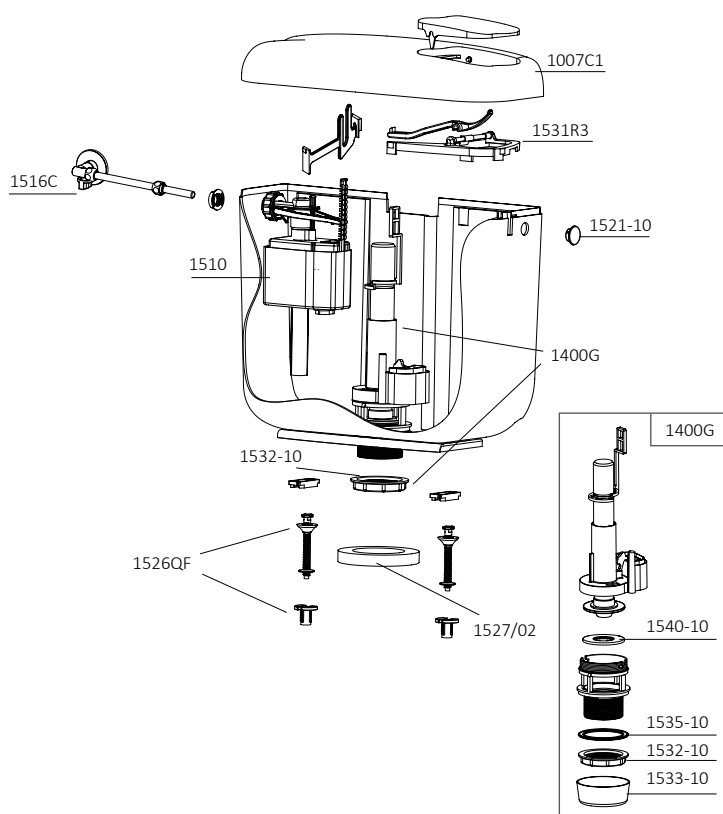

Ricambi - Spare parts (Dettagli - Details pag. 62)

1007C1	Coperchio completo di pulsante <i>Cover complete with push button</i>
1400G	Meccanismo di scarico con dado e controdado <i>Outlet valve with nut and back nut</i>
1510	Galleggiante Rambo 3/8" codolo ottone <i>Rambo filling valve 3/8" brass tang</i>
1516C	Rubinetto a squadra 1/2" ottone cromato per galleggianti 3/8" <i>1/2" chromate brass tap for 3/8" filling valves</i>
1521-10	Set 10 tappini laterali <i>Set 10 side plugs</i>
1526QF	Kit per fissaggio cassetta su vaso wc <i>Bowl fixing kit</i>
1527/02	Guarnizione gomma spugna in mousse epdm <i>Mousse epdm rubber gasket</i>
1531R3	Gruppo ponte con leve Concept 1 <i>Bridge with levers for Concept 1</i>
1532-10	Set 10 dadi per fissaggio meccanismo <i>Set 10 outlet valve nuts</i>
1533-10	Set 10 controdadi bianchi per fissaggio tubo Ø 50 <i>Set 10 fixing pipe back nuts Ø 50</i>
1535-10	Set 10 guarnizioni piane base meccanismo <i>Set 10 outlet valve flat gaskets</i>
1540-10	Set 10 guarnizioni di tenuta meccanismo <i>Set 10 outlet valve gasket</i>

Info packing

	Dimensioni imballo singolo <i>Single box dimensions</i>	48x14x41
	Peso imballo singolo <i>Weight single box</i>	2,50
	N° scatole singole su pallet <i>N° single box on a pallet</i>	60
	Dimensioni pallet <i>Pallet dimensions</i>	80x120x220
	N° scatole singole in cartone master <i>N° single box in a master box</i>	5
	Dimensioni cartone master <i>Master box dimensions</i>	72x48,5x43

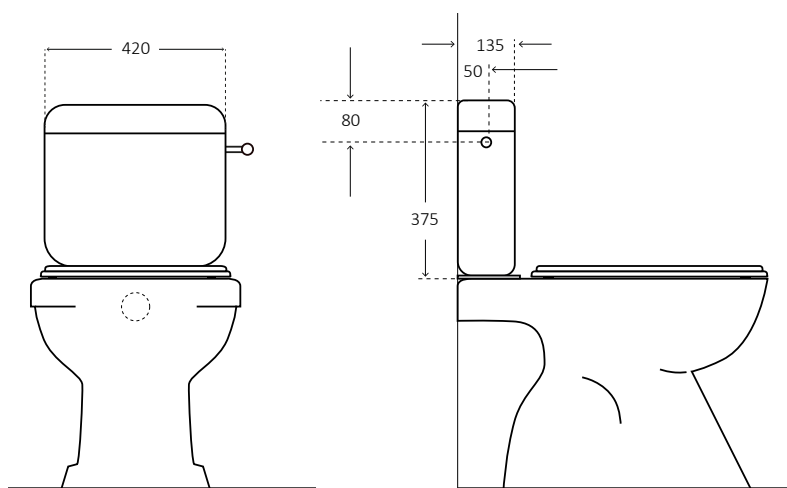

CONCEPT MONOBLOCK 2

Doppio scarico - Double flush



Caratteristiche tecniche

- Installazione in posizione monoblocco
- Scocca in ABS con trattamento anti invecchiamento
- Capacità 8 litri con possibilità di regolazione
- Omologazione 7 litri per normativa CE EN 14055
- Scarico parziale regolabile
- Coibentazione anticondensa ed insonorizzante
- Allacciamento idrico destro, sinistro o posteriore centrale
- Galleggiante 3/8" compatto, rapido e silenzioso

Technical features

- For monoblock installation
- ABS body with anti-age treatment
- 8 liters capacity with the possibility to adjust the amount of water
- 7 liters homologation according to CE standard EN 14055
- Adjustable partial flush
- Anti-condensate and soundproofing insulation
- Water connection right, left or central back
- 3/8" compact filling valve, safe, quick and silent

Adatta anche alla sostituzione di cassette in porcellana pre-esistenti

Also suitable for the replacement of the pre-existing vitreous china cisterns



DOWNLOAD
Vedi scheda tecnica
View technical sheet

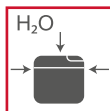

Art. / Item

Descrizione / Models

EAN

1000MC2

CONCEPT MONOBLOCK 2 bianca doppio scarico, senza rubinetto
CONCEPT MONOBLOCK 2 double flush, without tap, white

8029954080038

Equipaggiamento - Equipment



Galleggiante 3/8"
Rambo, codolo ottone
Filling valve Rambo,
with 3/8" brass tang



Meccanismo di scarico
Flushing valve



Piastra monoblocco
attacco universale
Monoblock base
universal fixing

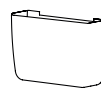

Isolamento
anti-condensa
Anti-condensation
insulation

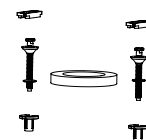

Kit di fissaggio per
vaso monoblocco
Fixing kit for
monoblock bowl

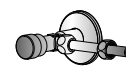

Rubinetto a squadra
Chromate tap

1000MC2





PROFESSIONAL



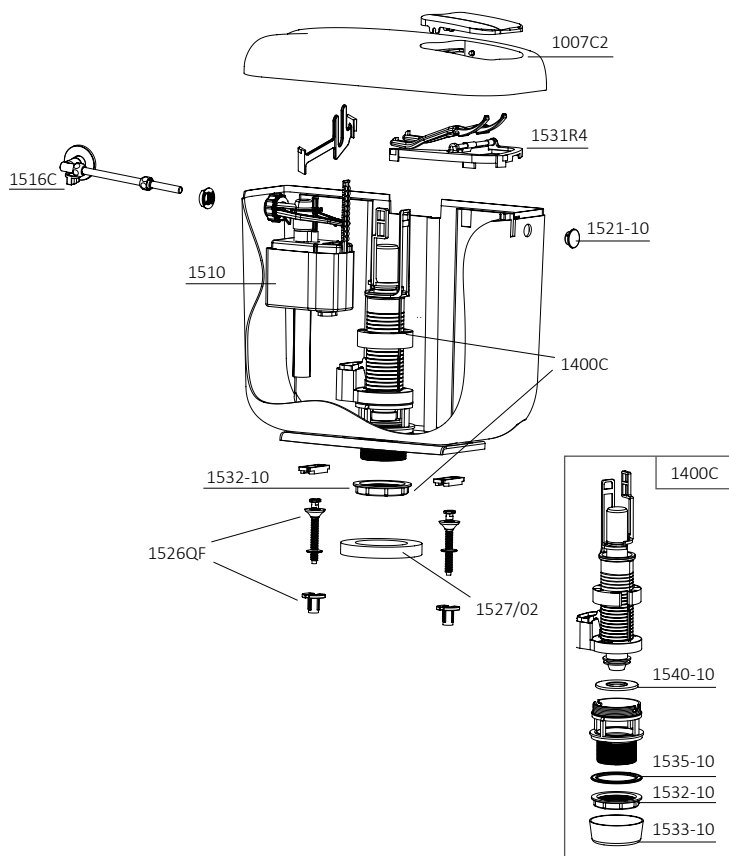



Line



Ricambi - Spare parts (Dettagli - Details pag. 63)

1007C2	Coperchio completo di pulsanti <i>Cover complete with push buttons</i>
1400C	Meccanismo di scarico con dado e controdado <i>Outlet valve with nut and back nut</i>
1510	Galleggiante Rambo 3/8" codolo ottone <i>Rambo filling valve 3/8" brass tang</i>
1516C	Rubinetto a squadra 1/2" ottone cromato per galleggianti 3/8" <i>1/2" chromate brass tap for 3/8" filling valves</i>
1521-10	Set 10 tappini laterali <i>Set 10 side plugs</i>
1526QF	Kit per fissaggio cassetta su vaso wc <i>Bowl fixing kit</i>
1527/02	Guarnizione gomma spugna in mousse epdm <i>Mousse epdm rubber gasket</i>
1531R4	Gruppo ponte con leve Concept 2 <i>Bridge with levers for Concept 2</i>
1532-10	Set 10 dadi per fissaggio meccanismo <i>Set 10 outlet valve nuts</i>
1533-10	Set 10 controdadi bianchi per fissaggio tubo Ø 50 <i>Set 10 fixing pipe back nuts Ø 50</i>
1535-10	Set 10 guarnizioni piane base meccanismo <i>Set 10 outlet valve flat gaskets</i>
1540-10	Set 10 guarnizioni di tenuta meccanismo <i>Set 10 outlet valve gasket</i>

Info packing

	Dimensioni imballo singolo <i>Single box dimensions</i>	48x14x41
	Peso imballo singolo <i>Weight single box</i>	2,54
	N° scatole singole su pallet <i>N° single box on a pallet</i>	60
	Dimensioni pallet <i>Pallet dimensions</i>	80x120x220
	N° scatole singole in cartone master <i>N° single box in a master box</i>	5
	Dimensioni cartone master <i>Master box dimensions</i>	72x48,5x43

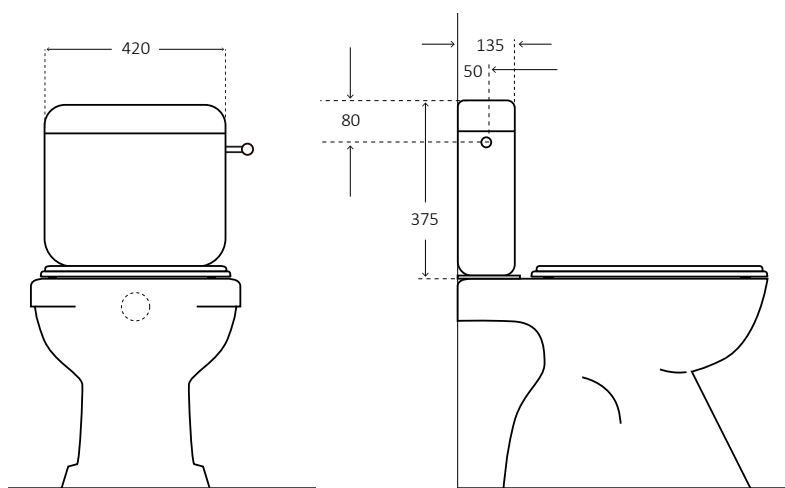

IDROCASSETTA CONCEPT 2

Doppio scarico - Double flush



PROFESSIONAL
Line

Caratteristiche tecniche

- Installazione bassa a zaino o media posizione
- Scocca in ABS con trattamento anti invecchiamento
- Capacità 8 litri con possibilità di regolazione
- Omologazione 7 litri per normativa CE EN 14055
- Scarico parziale regolabile
- Coibentazione anticondensa ed insonorizzante
- Allacciamento idrico destro, sinistro o posteriore centrale
- Galleggiante 3/8" compatto, rapido e silenzioso
- Accessoriata di tubo

Technical features

- For low or medium level installation
- ABS body with anti-age treatment
- 8 liters capacity with the possibility to adjust the amount of water
- 7 liters homologation according to CE standard EN 14055
- Adjustable partial flush
- Anti-condensate and soundproofing insulation
- Water connection right, left or central back
- 3/8" compact filling valve, safe, quick and silent
- Equipped with pipe

Ricambi - Spare parts

Vedi ricambi Concept 2 (pag. 56)
See spare parts of Concept 2 (pag. 56)

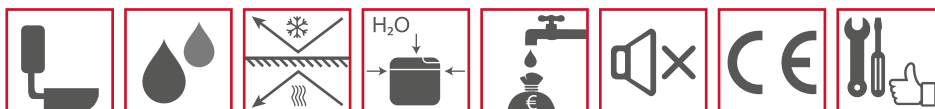

Art. / Item	Descrizione / Models	EAN
1000C2IDRO	IDROCASSETTA CONCEPT 2 bianca doppio scarico, con rubinetto CONCEPT HYDROCISTERN 2 double flush, with tap, white	8029954012565

Equipaggiamento - Equipment



Galleggiante 3/8"
Rambo, codolo ottone
Filling valve Rambo,
with 3/8" brass tang



Meccanismo di scarico e riduzione ø32
Flushing valve
and reduction ø32

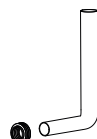

Tubo di scarico
Outlet pipe

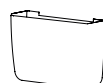

Isolamento anti-condensa
Anti-condensation insulation



Kit di fissaggio
Fixing kit

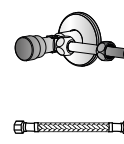

Rubinetto e tubo flessibile
Chromate tap
and flexible hose

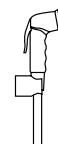

Doccetta shut-off
Shut-off shower

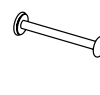

Portacarta cromato
Toilet paper
roll holder

1000C2IDRO



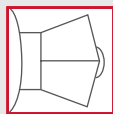

Attacco RUBINETTO per regolazione del flusso d'acqua
Rubinetto per regolare la pressione dell'acqua nella doccia

*TAP fitting for regulate water flow
Tap as pressure regulator of water in the shut-off shower*

DOCETTA SHUT-OFF cromata per una perfetta pulizia del vaso e per l'igiene personale (evitando l'uso del bidet)
Permette un attacco rubinetto multi uso per la pulizia del bagno

*SHOWER SHUT-OFF allows a perfect cleaning of toilet bowl
Usable for personal hygiene (avoiding usage of the bidet bowl)*

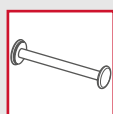





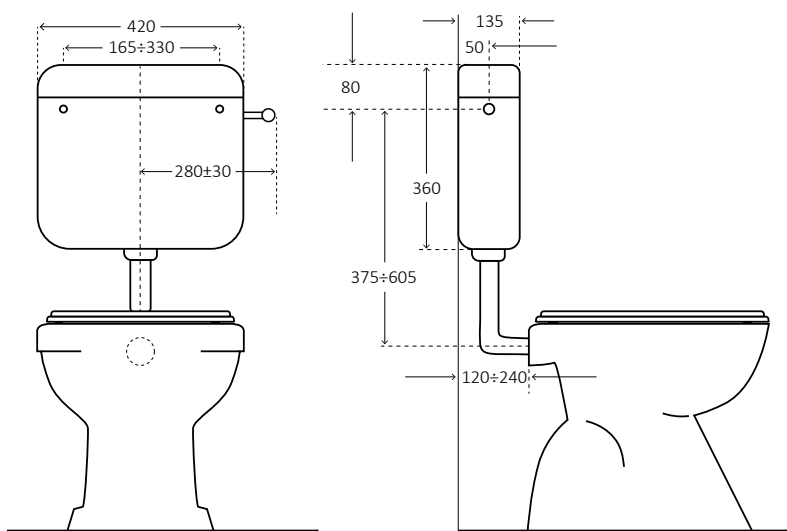

Cassetta equipaggiata di PORTACARTA CROMATO laterale per evitare inutili attacchi a parete, utilizzabile anche per asciugamano igienico
Sporgenza 14 cm

*Wc cistern equipped of TOILET PAPER ROLL HOLDER to avoid useless wall fixing, useless also for personal towel
Lenght 14 cm*

Info packing



 Dimensioni imballo singolo <i>Single box dimensions</i>	48x14x41
 Peso imballo singolo <i>Weight single box</i>	3,00
 N° scatole singole su pallet <i>N° single box on a pallet</i>	60
 Dimensioni pallet <i>Pallet dimensions</i>	80x120x220
 N° scatole singole in cartone master <i>N° single box in a master box</i>	5
 Dimensioni cartone master <i>Master box dimensions</i>	72x48,5x43

POLO

Scarico singolo - Single flush



Caratteristiche tecniche

- Dimensioni ridotte
- Installazione bassa a zaino o media posizione
- Scocca in ABS con trattamento anti invecchiamento
- Capacità 6 litri con possibilità di regolazione
- Tasto economizzatore d'acqua start/stop
- Coibentazione anticondensa ed insonorizzante
- Allacciamento idrico destro e sinistro
- Galleggiante 3/8" compatto, rapido e silenzioso
- Accessoriata di tubo

Technical features

- Extra small
- For low or medium level installation
- ABS body with anti-age treatment
- 6 liters capacity with the possibility to adjust the amount of water
- Single button with water-saving start/stop
- Anti-condensate and soundproofing insulation
- Water connection right, left or central back
- 3/8" compact filling valve, safe, quick and silent
- Equipped with pipe



Cassetta compatta per **risparmio acqua**
(16000 litri annui)

Compact wc cistern for **water saving**
(16000 liters per year)

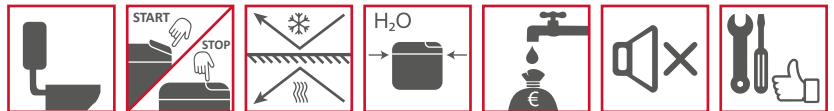

Art. / Item	Descrizione / Models	EAN
1070	POLO bianca start/stop, senza rubinetto POLO start/stop system, without tap, white	8029954000920

Equipaggiamento - Equipment



Galleggiante 3/8"
Blue, codolo ottone
Filling valve Blue,
with 3/8" brass tang

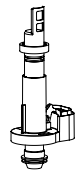

Meccanismo di scarico
Flushing valve

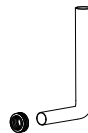

Tubo di scarico
Outlet pipe

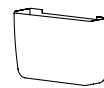

Isolamento anti-condensa
Anti-condensation insulation

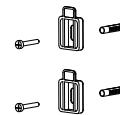

Kit di fissaggio
Fixing kit



Rubinetto a squadra
Chromate tap

1070	✓	✓	✓	✓	✓
------	---	---	---	---	---





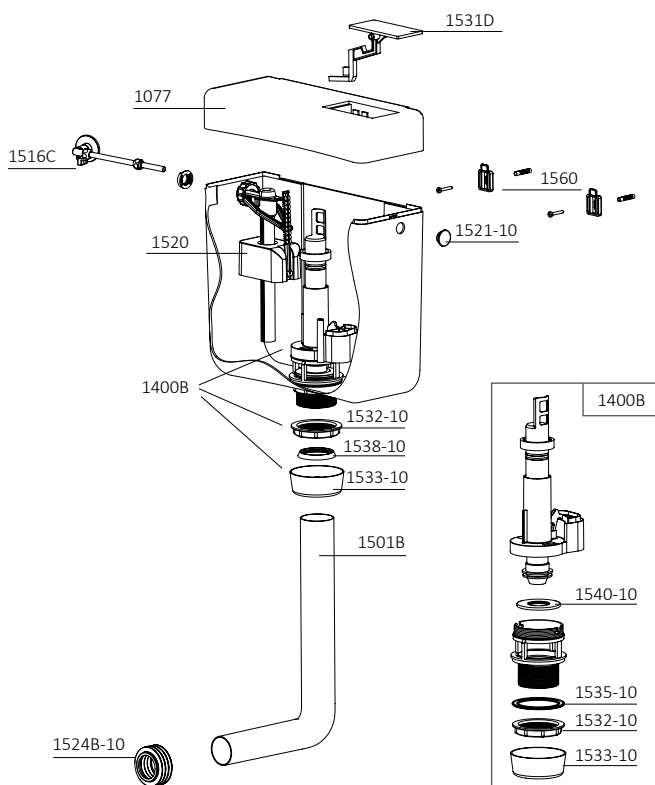



Ricambi - Spare parts (Dettagli - Details pag. 63)

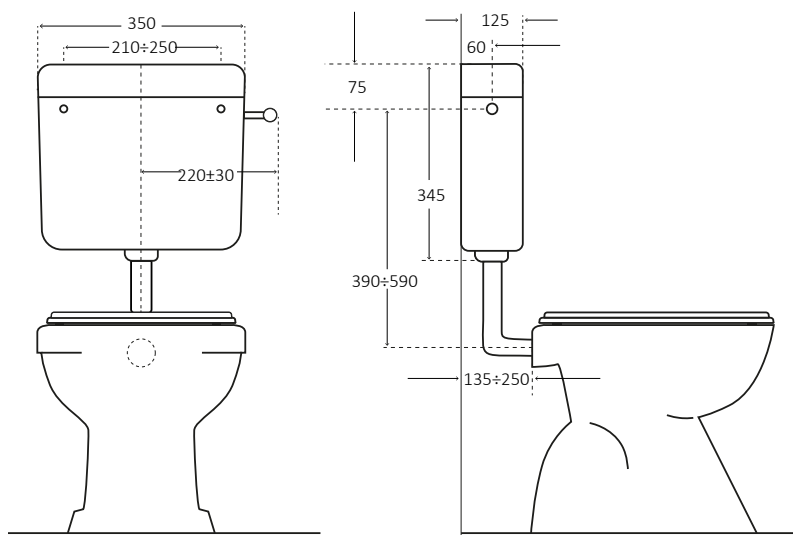

1077	Coperchio completo di pulsante <i>Cover complete with push button</i>
1400B	Meccanismo di scarico con dado e controdado <i>Outlet valve with nut and back nut</i>
1501B	Tubo di scarico Ø 50x44 lunghezza mm 346x225 <i>Pipe for wall low-level cistern Ø 50x44 mm 346x225</i>
1516C	Rubinetto a squadra 1/2" ottone cromato per galleggianti 3/8" <i>1/2" chromate brass tap for 3/8" filling valves</i>
1520	Galleggiante Blue 3/8" codolo ottone <i>Blue filling valve 3/8" brass tang</i>
1521-10	Set 10 tappini laterali <i>Set 10 side plugs</i>
1524B-10	Set 10 morsetti per vaso Ø esterno 55/60 Ø interno 44 <i>Set 10 bowl gaskets external Ø 55/60, internal Ø 44</i>
1531D	Pulsante <i>Push-button</i>
1532-10	Set 10 dadi per fissaggio meccanismo <i>Set 10 outlet valve nuts</i>
1533-10	Set 10 controdadi bianchi per fissaggio tubo Ø 50 <i>Set 10 fixing pipe back nuts Ø 50</i>
1535-10	Set 10 guarnizioni piane base meccanismo <i>Set 10 outlet valve flat gaskets</i>
1538-10	Set 10 guarnizioni coniche per tubo Ø 50 <i>Set 10 conical pipe gaskets Ø 50</i>
1540-10	Set 10 guarnizioni di tenuta meccanismo <i>Set 10 outlet valve gasket</i>
1560	Kit per fissaggio muro <i>Wall fixing kit</i>

Info packing



 Dimensioni imballo singolo <i>Single box dimensions</i>	40x15x39
 Peso imballo singolo <i>Weight single box</i>	2,20
 N° scatole singole su pallet <i>N° single box on a pallet</i>	80
 Dimensioni pallet <i>Pallet dimensions</i>	80x120x210
 N° scatole singole in cartone master <i>N° single box in a master box</i>	-
 Dimensioni cartone master <i>Master box dimensions</i>	-

ANGOLO

Scarico singolo - Single flush



Caratteristiche tecniche

- Installazione bassa a zaino o media posizione in angolo
- Scocca in ABS con trattamento anti invecchiamento
- Capacità 8 litri con possibilità di regolazione
- Omologazione 7 litri per normativa CE EN 14055
- Tasto economizzatore d'acqua start/stop
- Coibentazione anticondensa ed insonorizzante
- Allacciamento idrico destro o sinistro
- Galleggiante 3/8" compatto, rapido e silenzioso
- Accessoriata di tubo

Technical features

- For low or medium level installation in corner position
- ABS body with anti-age treatment
- 8 liters capacity with the possibility to adjust the amount of water
- 7 liters homologation according to CE standard EN 14055
- Single button with water-saving start/stop
- Anti-condensate and soundproofing insulation
- Water connection right or left
- 3/8" compact filling valve, safe, quick and silent
- Equipped with pipe

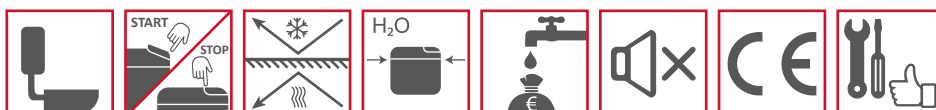

Art. / Item	Descrizione / Models	EAN
1050	ANGOLO bianca start/stop, senza rubinetto ANGOLO start/stop system, without tap, white	8029954000685
1051	ANGOLO bianca start/stop, con rubinetto ANGOLO start/stop system, with tap, white	8029954000692

Equipaggiamento - Equipment



Galleggiante 3/8"
Rambo, codolo ottone
Filling valve Rambo, with
3/8" brass tang

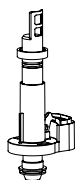

Meccanismo di
scarico
Flushing valve

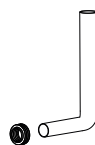

Tubo di scarico
Outlet pipe



Isolamento
anti-condensa
Anti-condensa-
tion insulation

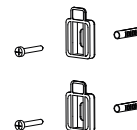

Kit di fissaggio
Fixing kit



Rubinetto a squadra
Chromate tap

1050	✓	✓	✓	✓	✓	
1051	✓	✓	✓	✓	✓	✓

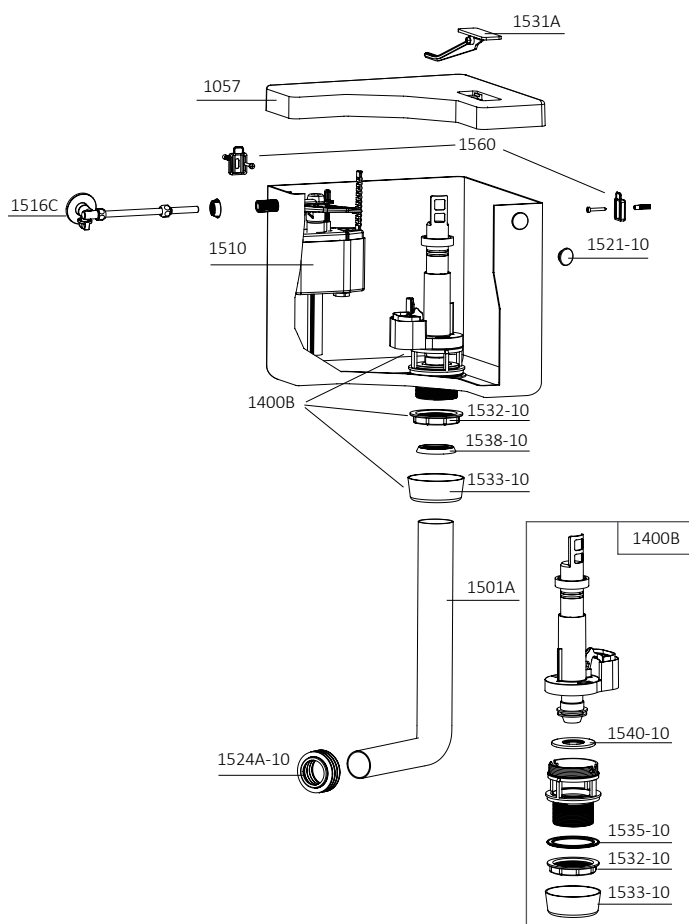





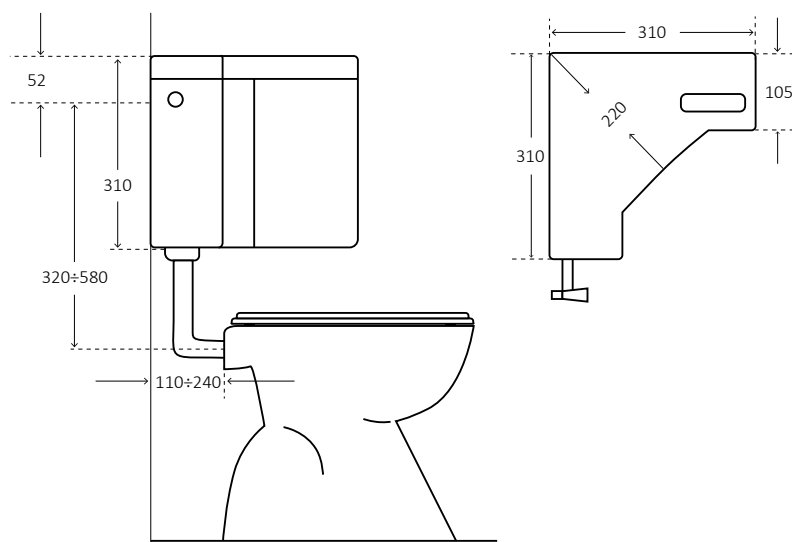

Ricambi - Spare parts (Dettagli - Details pag. 64)

1057	Coperchio completo di pulsante Cover complete with push button
1400B	Meccanismo di scarico con dado e controdado Outlet valve with nut and back nut
1501A	Tubo di scarico Ø 50x40 lunghezza mm 350x245 Pipe for wall low-level cistern Ø 50x40 mm 350x245
1510	Galleggiante Rambo 3/8" codolo ottone Rambo filling valve 3/8" brass tang
1516C	Rubinetto a squadra 1/2" ottone cromato per galleggianti 3/8" 1/2" chromate brass tap for 3/8" filling valves
1521-10	Set 10 tappini laterali Set 10 side plugs
1524A-10	Set 10 morsetti per vaso Ø esterno 55/60 Ø interno 40 Set 10 bowl gaskets external Ø 55/60, internal Ø 40
1531A	Pulsante Push-button
1532-10	Set 10 dadi per fissaggio meccanismo Set 10 outlet valve nuts
1533-10	Set 10 controdadi bianchi per fissaggio tubo Ø 50 Set 10 fixing pipe back nuts Ø 50
1535-10	Set 10 guarnizioni piane base meccanismo Set 10 outlet valve flat gaskets
1538-10	Set 10 guarnizioni coniche per tubo Ø 50 Set 10 conical pipe gaskets Ø 50
1540-10	Set 10 guarnizioni di tenuta meccanismo Set 10 outlet valve gasket
1560	Kit per fissaggio muro Wall fixing kit

Info packing



 Dimensioni imballo singolo Single box dimensions cm	32x32x36		
	 Peso imballo singolo Weight single box	1050	2,36
		1051	2,54
 N° scatole singole su pallet N° single box on a pallet	50		
 Dimensioni pallet Pallet dimensions cm	80x120x200		
 N° scatole singole in cartone master N° single box in a master box	-		
 Dimensioni cartone master Master box dimensions cm	-		

CONCEPT ALTA

Scarico singolo - Single flush



Caratteristiche tecniche

- Installazione in posizione alta
- Scocca in ABS con trattamento anti invecchiamento
- Capacità 8 litri con possibilità di regolazione
- Omologazione 7 litri per normativa CE EN 14055
- Tasto economizzatore d'acqua start/stop
- Coibentazione anticondensa ed insonorizzante
- Allacciamento idrico destro, sinistro o posteriore centrale
- Galleggiante 3/8" compatto, rapido e silenzioso
- Scarico con riduzione ø32 per tubi cassette alte
- Pull a perlina

Technical features

- For high level installation
- ABS body with anti-age treatment
- 8 liters capacity with the possibility to adjust the amount of water
- 7 liters homologation according to CE standard EN 14055
- Single button with water-saving start/stop
- Anti-condensate and soundproofing insulation
- Water connection right, left or central back
- 3/8" compact filling valve, safe, quick and silent
- Outlet with reduction ø32 for high level pipes
- Equipped with metal pull chain



DOWNLOAD

Vedi scheda tecnica
View technical sheet

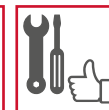
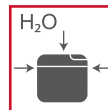
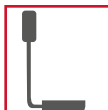

Art. / Item

Descrizione / Models

EAN

1000AC

CONCEPT 1 alta bianca start/stop, senza rubinetto
CONCEPT 1 high level cistern start/stop system, without tap, white

8029954080069

Equipaggiamento - Equipment



Galleggiante 3/8"
Rambo, codolo ottone
Filling valve Rambo,
with 3/8" brass tang

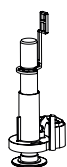

Meccanismo di
scarico
Flushing valve



Tubo di scarico
Outlet pipe



Isolamento
anti-condensa
Anti-condensation
insulation

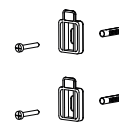

Kit di fissaggio
Fixing kit



Rubinetto a squadra
Chromate tap

1000AC





PROFESSIONAL

Line

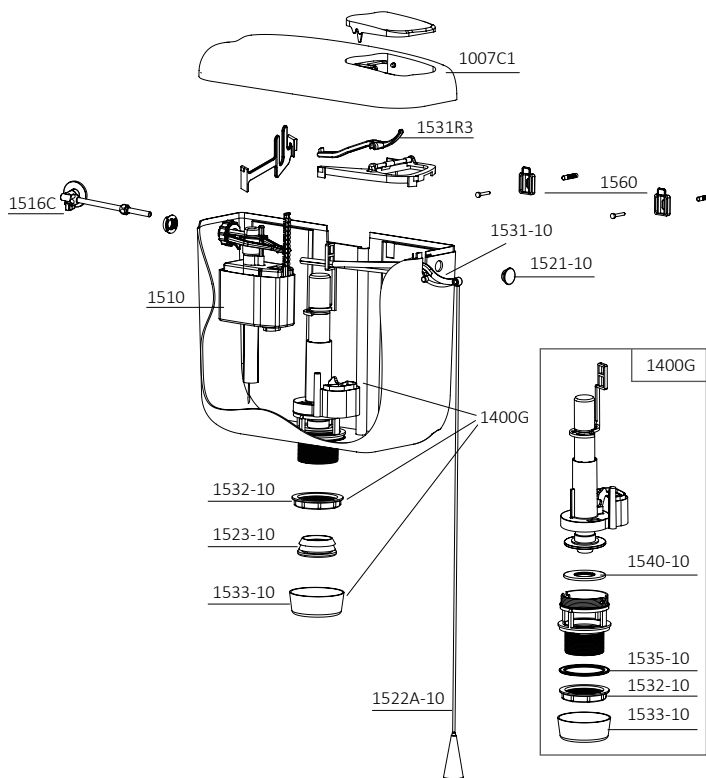





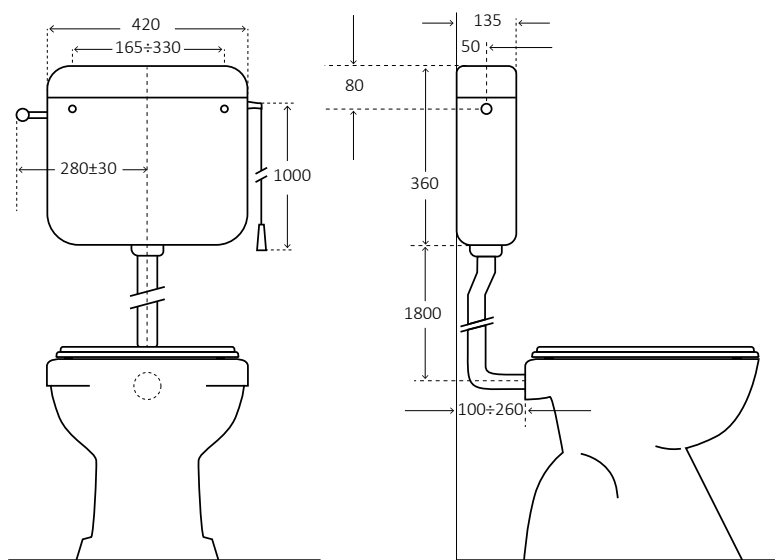

Ricambi - Spare parts (Dettagli - Details pag. 64)

1007C1	Coperchio completo di pulsante <i>Cover complete with push button</i>
1400G	Meccanismo di scarico con dado e controdado <i>Outlet valve with nut and back nut</i>
1510	Galleggiante Rambo 3/8" codolo ottone <i>Rambo filling valve 3/8" brass tang</i>
1516C	Rubinetto a squadra 1/2" ottone cromato per galleggianti 3/8" <i>1/2" chromate brass tap for 3/8" filling valves</i>
1521-10	Set 10 tappini laterali <i>Set 10 side plugs</i>
1522A-10	Set 10 pull a perlina <i>Set 10 metal pull chain</i>
1523-10	Set 10 morsetti per vaso Ø esterno 48/50 Ø interno 32 <i>Set 10 bowl gaskets external Ø 48/50, internal Ø 32</i>
1531-10	Set 10 leve per cassetta alta <i>Set 10 levers for high level cistern</i>
1531R3	Gruppo ponte con leve Concept 1 <i>Bridge with levers for Concept 1</i>
1532-10	Set 10 dadi per fissaggio meccanismo <i>Set 10 outlet valve nuts</i>
1533-10	Set 10 controdadi bianchi per fissaggio tubo Ø 50 <i>Set 10 fixing pipe back nuts Ø 50</i>
1535-10	Set 10 guarnizioni piane base meccanismo <i>Set 10 outlet valve flat gaskets</i>
1540-10	Set 10 guarnizioni di tenuta meccanismo <i>Set 10 outlet valve gasket</i>
1560	Kit per fissaggio muro <i>Wall fixing kit</i>

Info packing



 Dimensioni imballo singolo <i>Single box dimensions</i>	48x14x41
 Peso imballo singolo <i>Weight single box</i>	2,46
 N° scatole singole su pallet <i>N° single box on a pallet</i>	60
 Dimensioni pallet <i>Pallet dimensions</i>	80x120x220
 N° scatole singole in cartone master <i>N° single box in a master box</i>	5
 Dimensioni cartone master <i>Master box dimensions</i>	72x48,5x43

Scarico singolo - Single flush



Caratteristiche tecniche

- Installazione alta
- Scocca in ABS con trattamento anti invecchiamento
- Capacità 8 litri con possibilità di regolazione
- Allacciamento idrico destro o sinistro
- Galleggiante 3/8" compatto, rapido e silenzioso
- Coperchio a richiesta (art. 1041S)

Technical features

- For high level installation
- ABS body with anti-age treatment
- 8 liters capacity with the possibility to adjust the amount of water
- Water connection right or left
- 3/8" compact filling valve, safe, quick and silent
- Cover by request (art. 1041S)



DOWNLOAD

Vedi scheda tecnica
View technical sheet

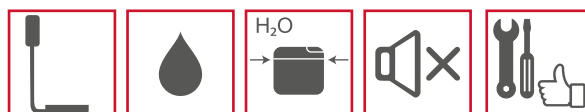

Art. / Item	Descrizione / Models	EAN
1041	ALFA bianca completa, senza coperchio ALFA without cover, white	8029954000456
1041S	ALFA bianca completa, con coperchio e imballo singolo ALFA with cover and single packing, white	8029954000517

Equipaggiamento - Equipment



Galleggiante 3/8"
Blue, codolo plastica
Filling valve Blue,
with 3/8" pom tang

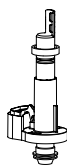

Meccanismo di
scarico
Flushing valve



Tubo di scarico
Outlet pipe



Isolamento
anti-condensa
Anti-condensa-
tion insulation

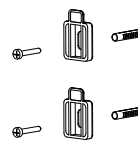

Kit di fissaggio
Fixing kit



Coperchio
Cover

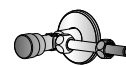

Rubinetto a squadra
Chromate tap

1041	✓	✓			✓		
1041S	✓	✓			✓	✓	





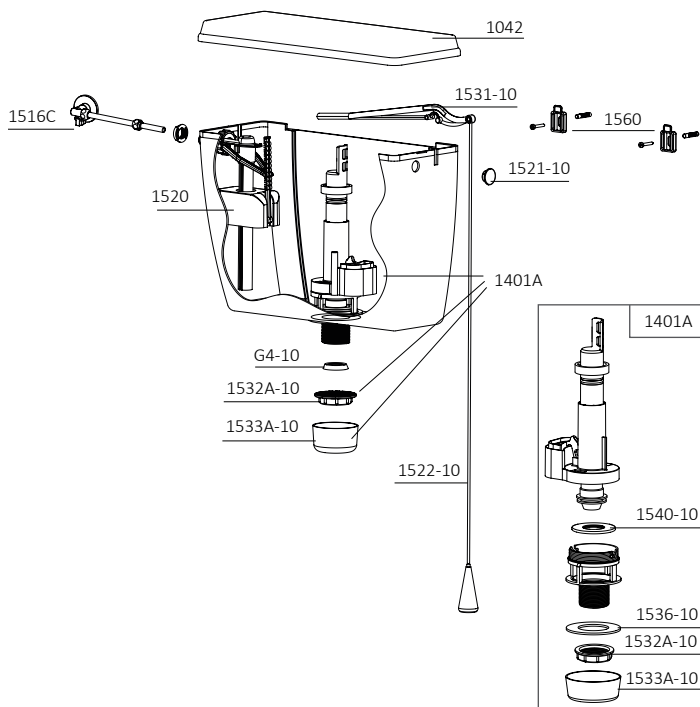

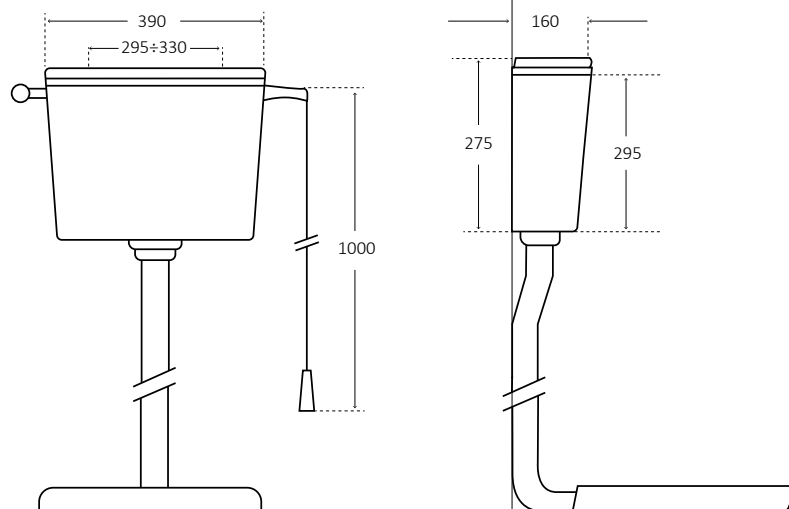

Ricambi - Spare parts (Dettagli - Details pag. 65)



1042	Coperchio Cover
1401A	Meccanismo di scarico con dado e controdado Outlet valve with nut and back nut
1516C	Rubinetto a squadra 1/2" ottone cromato per galleggianti 3/8" 1/2" chromate brass tap for 3/8" filling valves
1520	Galleggiante Blue 3/8" codolo ottone Blue filling valve 3/8" brass tang
1521-10	Set 10 tappini laterali Set 10 side plugs
1522-10	Set 10 pull a cordina Set 10 rope pull
1531-10	Set 10 leve per cassetta alta Set 10 levers for high level cistern
1532A-10	Set 10 dadi per fissaggio meccanismo Set 10 outlet valve nuts
1533A-10	Set 10 controdadi bianchi per fissaggio tubo Ø 32 Set 10 fixing pipe back nuts Ø 32
1536-10	Set 10 guarnizioni piane base meccanismo Set 10 outlet valve flat gaskets
1540-10	Set 10 guarnizioni di tenuta meccanismo Set 10 outlet valve gaskets
1560	Kit per fissaggio muro Wall fixing kit
G4-10	Set 10 guarnizioni coniche per tubo Ø 32 Set 10 conical pipe gasket Ø 32



Info packing

 Dimensioni imballo singolo Single box dimensions	1041	39,5x16x27,5
	1041S	40,5x17x29,5
 Peso imballo singolo Weight single box	1041	1,36
	1041S	1,92
 N° scatole singole su pallet N° single box on a pallet	1041	-
	1041S	84
 Dimensioni pallet Pallet dimensions	80x120x255	
 N° scatole singole in cartone master N° single box in a master box	1041	10
	1041S	6
 Dimensioni cartone master Master box dimensions	1041	72x41,5x33
	1041S	60,5x42x53

CABRIO

Scarico singolo - Single flush



Caratteristiche tecniche

- Installazione alta
- Capacità 8 litri con possibilità di regolazione
- Allacciamento idrico destro o sinistro
- Galleggiante 3/8" compatto, rapido e silenzioso (art. 1046)

Technical features

- For high level installation
- 8 liters capacity with the possibility to adjust the amount of water
- Water connection right or left
- 3/8" compact filling valve, safe, quick and silent (art.1046)



DOWNLOAD

Vedi scheda tecnica
View technical sheet

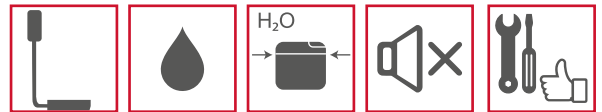

Art. / Item	Descrizione / Models	EAN
1046	CABRIO completa, senza coperchio, bianca CABRIO complete, without cover, white	8029954000616

Equipaggiamento - Equipment



Galleggiante 3/8"
Blue, codolo ottone
Filling valve Blue,
with 3/8" brass tang

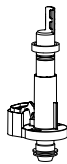

Meccanismo di
scarico
Flushing valve



Tubo di scarico
Outlet pipe

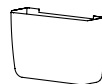

Isolamento
anti-condensa
Anti-condensa-
tion insulation

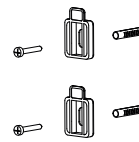

Kit di fissaggio
Fixing kit

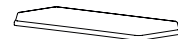

Coperchio
Cover

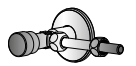

Rubinetto a squadra
Chromate tap

1046



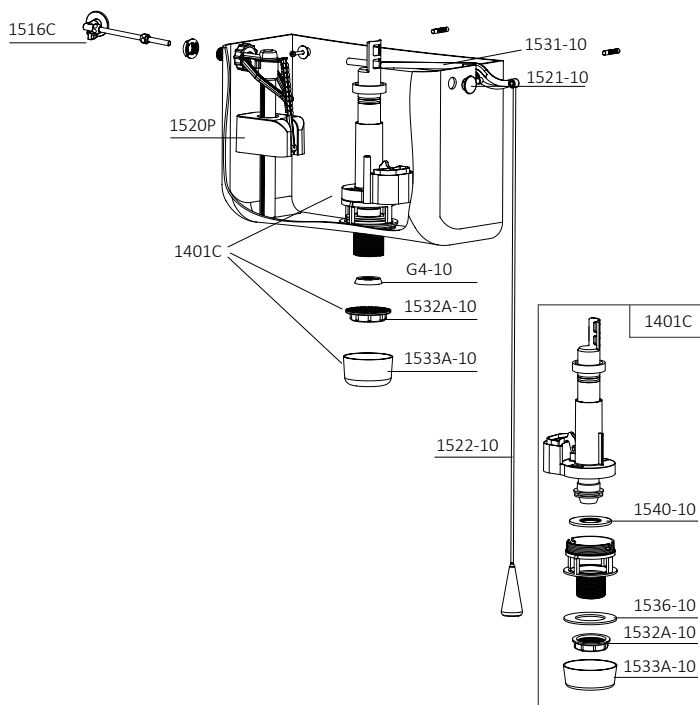





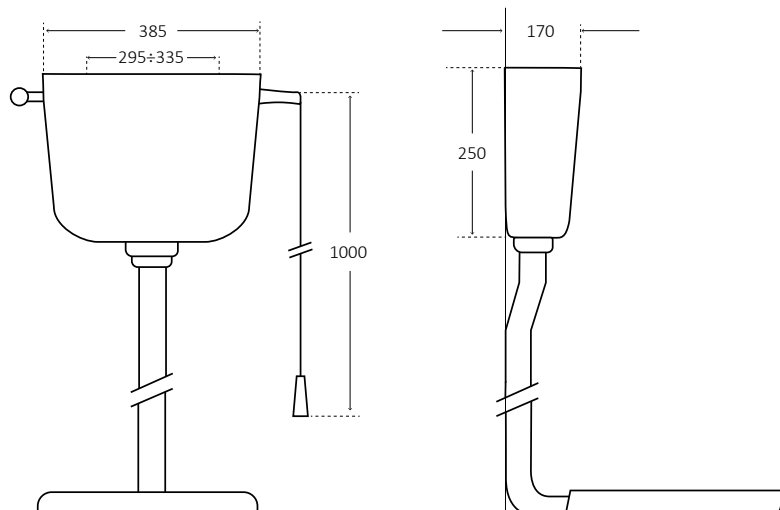

Ricambi - Spare parts (Dettagli - Details pag. 65)

1401C	Meccanismo di scarico con dado e controdado <i>Outlet valve with nut and back nut</i>
1516C	Rubinetto a squadra 1/2" ottone cromato per galleggianti 3/8" <i>1/2" chromate brass tap for 3/8" filling valves</i>
1520P	Galleggiante Blue 3/8" codolo plastica <i>Blue filling valve 3/8" pom tang</i>
1521-10	Set 10 tappini laterali <i>Set 10 side plugs</i>
1522-10	Set 10 pull a cordina <i>Set 10 rope pull</i>
1531-10	Set 10 leve per cassetta alta <i>Set 10 levers for high level cistern</i>
1532A-10	Set 10 dadi per fissaggio meccanismo <i>Set 10 outlet valve nuts</i>
1533A-10	Set 10 controdadi bianchi per fissaggio tubo Ø 32 <i>Set 10 fixing pipe back nuts Ø 32</i>
1536-10	Set 10 guarnizioni piane base meccanismo <i>Set 10 outlet valve flat gaskets</i>
1540-10	Set 10 guarnizioni di tenuta meccanismo <i>Set 10 outlet valve gaskets</i>
G4-10	Set 10 guarnizioni coniche per tubo Ø 32 <i>Set 10 conical pipe gasket Ø 32</i>

Info packing



 Dimensioni prodotto singolo <i>Single product dimensions</i>	38,5x17x25
 Peso pezzo singolo <i>Weight single piece</i>	1,14
 N° scatole singole su pallet <i>N° single box on a pallet</i>	-
 Dimensioni pallet <i>Pallet dimensions</i>	-
 N° pezzi singoli in cartone master <i>N° single pieces in a master box</i>	12
 Dimensioni cartone master <i>Master box dimensions</i>	80x40x36



Concept 1

Art. / Item	Descrizione / Models	EAN
1007C1	Coperchio completo di pulsante <i>Cover complete with push button</i>	8029954080076
1408G	Meccanismo di scarico pneumatico <i>Pneumatic outlet valve</i>	8029954004416
1501A	Tubo di scarico Ø 50x40 lunghezza mm 350x245 <i>Pipe for wall low-level cistern Ø 50x40 mm 350x245</i>	8029954004041
1510	Galleggiante Rambo 3/8" codolo ottone <i>Rambo floating valve 3/8" brass tang</i>	8029954003709
1516C	Rubinetto a squadra 1/2" ottone cromato per galleggianti 3/8" <i>1/2" chromate brass tap for 3/8" filling valves</i>	8029954005246
1521-10	Set 10 tappini laterali <i>Set 10 side plugs</i>	8029954008827
1524A-10	Set 10 morsetti per vaso Ø esterno 55/60 Ø interno 40 <i>Set 10 bowl gaskets external Ø 55/60, internal Ø 40</i>	8029954007875
1531R3	Gruppo ponte con leve Concept 1 <i>Bridge with levers for Concept 1</i>	8029954080205
1532-10	Set 10 dadi per fissaggio meccanismo <i>Set 10 outlet valve nut</i>	8029954008780
1533-10	Set 10 controdadi bianchi per fissaggio tubo Ø 50 <i>Set 10 fixing pipe back nuts Ø 50</i>	8029954008797
1535-10	Set 10 guarnizioni piane base meccanismo <i>Set 10 outlet valve flat gasket</i>	8029954007592
1538-10	Set 10 guarnizioni coniche per tubo Ø 50 <i>Set 10 conical pipe gaskets Ø 50</i>	8029954007878
1540-10	Set 10 guarnizioni di tenuta meccanismo <i>Set 10 outlet valve gaskets</i>	8029954007523
1560	Kit per fissaggio muro <i>Wall fixing kit</i>	8029954003518
PE	Pulsante esterno completo di tubetto e canalina <i>External push-button complete with pipe and tube</i>	8029954004324
PI	Pulsante incasso completo di tubetto e guaina <i>External push-button complete with pipe and sheath</i>	8029954004331



Concept 2

Art. / Item	Descrizione / Models	EAN
1007C2	Coperchio completo di pulsanti <i>Cover complete with push buttons</i>	8029954080083
1400C	Meccanismo di scarico con dado e controdado <i>Outlet valve with nut and back nut</i>	8029954003228
1501A	Tubo di scarico Ø 50x40 lunghezza mm 350x245 <i>Pipe for wall low-level cistern Ø 50x40 mm 350x245</i>	8029954004041
1510	Galleggiante Rambo 3/8" codolo ottone <i>Rambo floating valve 3/8" brass tang</i>	8029954003709
1516C	Rubinetto a squadra 1/2" ottone cromato per galleggianti 3/8" <i>1/2" chromate brass tap for 3/8" filling valves</i>	8029954005246
1521-10	Set 10 tappini laterali <i>Set 10 side plugs</i>	8029954008827
1524-10	Set 10 morsetti per vaso Ø esterno 55/60 Ø interno 32 <i>Set 10 bowl gaskets external Ø 55/60, internal Ø 32</i>	8029954007868
1524A-10	Set 10 morsetti per vaso Ø esterno 55/60 Ø interno 40 <i>Set 10 bowl gaskets external Ø 55/60, internal Ø 40</i>	8029954007875
1531R4	Gruppo ponte con leve Concept 2 <i>Bridge with levers for Concept 2</i>	8029954080212
1532-10	Set 10 dadi per fissaggio meccanismo <i>Set 10 outlet valve nut</i>	8029954008780
1533-10	Set 10 controdadi bianchi per fissaggio tubo Ø 50 <i>Set 10 fixing pipe back nuts Ø 50</i>	8029954008797
1535-10	Set 10 guarnizioni piane base meccanismo <i>Set 10 outlet valve flat gasket</i>	8029954007592
1538-10	Set 10 guarnizioni coniche per tubo Ø 50 <i>Set 10 conical pipe gaskets Ø 50</i>	8029954007878
1540-10	Set 10 guarnizioni di tenuta meccanismo <i>Set 10 outlet valve gaskets</i>	8029954007523
1560	Kit per fissaggio muro <i>Wall fixing kit</i>	8029954003518



Delta 1

Art. / Item	Descrizione / Models	EAN
1087S	Coperchio completo di pulsante per Delta 1 <i>Cover complete with push button for wc cistern Delta 1</i>	8029954008254
1400B	Meccanismo di scarico con dado e controdamo <i>Outlet valve with nut and back nut</i>	8029954003211
1501A	Tubo di scarico Ø 50x40 lunghezza mm 350x245 <i>Pipe for wall low-level cistern Ø 50x40 mm 350x245</i>	8029954004041
1510	Galleggiante Rambo 3/8" codolo ottone <i>Rambo floating valve 3/8" brass tang</i>	8029954003709
1516C	Rubinetto a squadra 1/2" ottone cromato per galleggianti 3/8" <i>1/2" chromate brass tap for 3/8" filling valves</i>	8029954005246
1521-10	Set 10 tappini laterali <i>Set 10 side plugs</i>	8029954008827
1524A-10	Set 10 morsetti per vaso Ø esterno 55/60 Ø interno 40 <i>Set 10 bowl gaskets external Ø 55/60, internal Ø 40</i>	8029954007875
1531N	Tasto singolo con leva <i>Single push button with lever</i>	8029954010950
1532-10	Set 10 dadi per fissaggio meccanismo <i>Set 10 outlet valve nut</i>	8029954008780
1533-10	Set 10 controdadi bianchi per fissaggio tubo Ø 50 <i>Set 10 fixing pipe back nuts Ø 50</i>	8029954008797
1535-10	Set 10 guarnizioni piane base meccanismo <i>Set 10 outlet valve flat gasket</i>	8029954007592
1538-10	Set 10 guarnizioni coniche per tubo Ø 50 <i>Set 10 conical pipe gaskets Ø 50</i>	8029954007878
1540-10	Set 10 guarnizioni di tenuta meccanismo <i>Set 10 outlet valve gaskets</i>	8029954007523
1560	Kit per fissaggio muro <i>Wall fixing kit</i>	8029954003518



Delta 2

Art. / Item	Descrizione / Models	EAN
1087S2	Coperchio completo di pulsanti per Delta 2 <i>Cover complete with push buttons for wc cistern Delta 2</i>	8029954008261
1400H	Meccanismo di scarico con dado e controdamo <i>Outlet valve with nut and back nut</i>	8029954080236
1501A	Tubo di scarico Ø 50x40 lunghezza mm 350x245 <i>Pipe for wall low-level cistern Ø 50x40 mm 350x245</i>	8029954004041
1510	Galleggiante Rambo 3/8" codolo ottone <i>Rambo floating valve 3/8" brass tang</i>	8029954003709
1516C	Rubinetto a squadra 1/2" ottone cromato per galleggianti 3/8" <i>1/2" chromate brass tap for 3/8" filling valves</i>	8029954005246
1521-10	Set 10 tappini laterali <i>Set 10 side plugs</i>	8029954008827
1524A-10	Set 10 morsetti per vaso Ø esterno 55/60 Ø interno 40 <i>Set 10 bowl gaskets external Ø 55/60, internal Ø 40</i>	8029954007875
1531N3	Gruppo ponte con leve Delta 2 <i>Bridge with levers for Delta 2</i>	8029954010974
1532-10	Set 10 dadi per fissaggio meccanismo <i>Set 10 outlet valve nut</i>	8029954008780
1533-10	Set 10 controdadi bianchi per fissaggio tubo Ø 50 <i>Set 10 fixing pipe back nuts Ø 50</i>	8029954008797
1535-10	Set 10 guarnizioni piane base meccanismo <i>Set 10 outlet valve flat gasket</i>	8029954007592
1538-10	Set 10 guarnizioni coniche per tubo Ø 50 <i>Set 10 conical pipe gaskets Ø 50</i>	8029954007878
1540-10	Set 10 guarnizioni di tenuta meccanismo <i>Set 10 outlet valve gaskets</i>	8029954007523
1560	Kit per fissaggio muro <i>Wall fixing kit</i>	8029954003518



Sfera 1

Art. / Item	Descrizione / Models	EAN
1007S1	Coperchio completo di pulsante <i>Cover complete with push button</i>	8029954005239
1400F	Meccanismo di scarico con dado e controdado <i>Outlet valve with nut and back nut</i>	8029954012534
1501A	Tubo di scarico Ø 50x40 lunghezza mm 350x245 <i>Pipe for wall low-level cistern Ø 50x40 mm 350x245</i>	8029954004041
1501	Tubo di scarico Ø 50x32 lunghezza mm 346x225 <i>Pipe for wall low-level cistern Ø 50x32 mm 346x225</i>	8029954004034
1510	Galleggiante Rambo 3/8" codolo ottone <i>Rambo floating valve 3/8" brass tang</i>	8029954003709
1516C	Rubinetto a squadra 1/2" ottone cromato per galleggianti 3/8" <i>1/2" chromate brass tap for 3/8" filling valves</i>	8029954005246
1521-10	Set 10 tappini laterali <i>Set 10 side plugs</i>	8029954008827
1524A-10	Set 10 morsetti per vaso Ø esterno 55/60 Ø interno 40 <i>Set 10 bowl gaskets external Ø 55/60, internal Ø 40</i>	8029954007875
1524-10	Set 10 morsetti per vaso Ø esterno 55/60 Ø interno 32 <i>Set 10 bowl gaskets external Ø 55/60, internal Ø 32</i>	8029954007868
1532-10	Set 10 dadi per fissaggio meccanismo <i>Set 10 outlet valve nut</i>	8029954008780
1533-10	Set 10 controdadi bianchi per fissaggio tubo Ø 50 <i>Set 10 fixing pipe back nuts Ø 50</i>	8029954008797
1535-10	Set 10 guarnizioni piane base meccanismo <i>Set 10 outlet valve flat gasket</i>	8029954007592
1538-10	Set 10 guarnizioni coniche per tubo Ø 50 <i>Set 10 conical pipe gaskets Ø 50</i>	8029954007878
1540-10	Set 10 guarnizioni di tenuta meccanismo <i>Set 10 outlet valve gaskets</i>	8029954007523
1560	Kit per fissaggio muro <i>Wall fixing kit</i>	8029954003518



Sfera 2

Art. / Item	Descrizione / Models	EAN
1007S2	Coperchio completo di pulsanti <i>Cover complete with push buttons</i>	8029954000715
1400C	Meccanismo di scarico con dado e controdado <i>Outlet valve with nut and back nut</i>	8029954003228
1501A	Tubo di scarico Ø 50x40 lunghezza mm 350x245 <i>Pipe for wall low-level cistern Ø 50x40 mm 350x245</i>	8029954004041
1510	Galleggiante Rambo 3/8" codolo ottone <i>Rambo floating valve 3/8" brass tang</i>	8029954003709
1516C	Rubinetto a squadra 1/2" ottone cromato per galleggianti 3/8" <i>1/2" chromate brass tap for 3/8" filling valves</i>	8029954005246
1521-10	Set 10 tappini laterali <i>Set 10 side plugs</i>	8029954008827
1524A-10	Set 10 morsetti per vaso Ø esterno 55/60 Ø interno 40 <i>Set 10 bowl gaskets external Ø 55/60, internal Ø 40</i>	8029954007875
1524-10	Set 10 morsetti per vaso Ø esterno 55/60 Ø interno 32 <i>Set 10 bowl gaskets external Ø 55/60, internal Ø 32</i>	8029954007868
1531F3	Gruppo ponte con leve Sfera 2 <i>Bridge with levers for Sfera 2</i>	8029954080199
1532-10	Set 10 dadi per fissaggio meccanismo <i>Set 10 outlet valve nut</i>	8029954008780
1533-10	Set 10 controdadi bianchi per fissaggio tubo Ø 50 <i>Set 10 fixing pipe back nuts Ø 50</i>	8029954008797
1535-10	Set 10 guarnizioni piane base meccanismo <i>Set 10 outlet valve flat gasket</i>	8029954007592
1538-10	Set 10 guarnizioni coniche per tubo Ø 50 <i>Set 10 conical pipe gaskets Ø 50</i>	8029954007878
1540-10	Set 10 guarnizioni di tenuta meccanismo <i>Set 10 outlet valve gaskets</i>	8029954007523
1560	Kit per fissaggio muro <i>Wall fixing kit</i>	8029954003518



Plus 1

Art. / Item	Descrizione / Models	EAN
1037S	Coperchio completo di pulsante <i>Cover complete with push button</i>	8029954000401
1400B	Meccanismo di scarico con dado e controdamo <i>Outlet valve with nut and back nut</i>	8029954003211
1501A	Tubo di scarico Ø 50x40 lunghezza mm 350x245 <i>Pipe for wall low-level cistern Ø 50x40 mm 350x245</i>	8029954004041
1510	Galleggiante Rambo 3/8" codolo ottone <i>Rambo floating valve 3/8" brass tang</i>	8029954003709
1516C	Rubinetto a squadra 1/2" ottone cromato per galleggianti 3/8" <i>1/2" chromate brass tap for 3/8" filling valves</i>	8029954005246
1521-10	Set 10 tappini laterali <i>Set 10 side plugs</i>	8029954008827
1524A-10	Set 10 morsetti per vaso Ø esterno 55/60 Ø interno 40 <i>Set 10 bowl gaskets external Ø 55/60, internal Ø 40</i>	8029954007875
1531S	Tasto singolo con leva <i>Single push button with lever</i>	8029954003655
1532-10	Set 10 dadi per fissaggio meccanismo <i>Set 10 outlet valve nut</i>	8029954008780
1533-10	Set 10 controdadi bianchi per fissaggio tubo Ø 50 <i>Set 10 fixing pipe back nuts Ø 50</i>	8029954008797
1535-10	Set 10 guarnizioni piane base meccanismo <i>Set 10 outlet valve flat gasket</i>	8029954007592
1538-10	Set 10 guarnizioni coniche per tubo Ø 50 <i>Set 10 conical pipe gaskets Ø 50</i>	8029954007878
1540-10	Set 10 guarnizioni di tenuta meccanismo <i>Set 10 outlet valve gaskets</i>	8029954007523
1560	Kit per fissaggio muro <i>Wall fixing kit</i>	8029954003518



Plus 2

Art. / Item	Descrizione / Models	EAN
1037S2	Coperchio completo di pulsanti <i>Cover complete with push buttons</i>	8029954000401
1400B2	Meccanismo di scarico con dado e controdamo <i>Outlet valve with nut and back nut</i>	8029954003273
1501A	Tubo di scarico Ø 50x40 lunghezza mm 350x245 <i>Pipe for wall low-level cistern Ø 50x40 mm 350x245</i>	8029954004041
1510	Galleggiante Rambo 3/8" codolo ottone <i>Rambo floating valve 3/8" brass tang</i>	8029954003709
1516C	Rubinetto a squadra 1/2" ottone cromato per galleggianti 3/8" <i>1/2" chromate brass tap for 3/8" filling valves</i>	8029954005246
1521-10	Set 10 tappini laterali <i>Set 10 side plugs</i>	8029954008827
1524A-10	Set 10 morsetti per vaso Ø esterno 55/60 Ø interno 40 <i>Set 10 bowl gaskets external Ø 55/60, internal Ø 40</i>	8029954007875
1531S2	Doppio tasto con leva <i>Double push button with lever</i>	8029954001002
1532-10	Set 10 dadi per fissaggio meccanismo <i>Set 10 outlet valve nut</i>	8029954008780
1533-10	Set 10 controdadi bianchi per fissaggio tubo Ø 50 <i>Set 10 fixing pipe back nuts Ø 50</i>	8029954008797
1535/02-10	Set 10 guarnizioni piane base meccanismo <i>Set 10 outlet valve flat gasket</i>	8029954007592
1538-10	Set 10 guarnizioni coniche per tubo Ø 50 <i>Set 10 conical pipe gaskets Ø 50</i>	8029954007878
1540-10	Set 10 guarnizioni di tenuta meccanismo <i>Set 10 outlet valve gaskets</i>	8029954007523
1560	Kit per fissaggio muro <i>Wall fixing kit</i>	8029954003518



Smart

Art. / Item	Descrizione / Models	EAN
1087	Coperchio completo di pulsante <i>Cover complete with push button</i>	8029954001101
1400B	Meccanismo di scarico con dado e controdado <i>Outlet valve with nut and back nut</i>	8029954003211
1501A	Tubo di scarico Ø 50x40 lunghezza mm 350x245 <i>Pipe for wall low-level cistern Ø 50x40 mm 350x245</i>	8029954004041
1510	Galleggiante Rambo 3/8" codolo ottone <i>Rambo floating valve 3/8" brass tang</i>	8029954003709
1516C	Rubinetto a squadra 1/2" ottone cromato per galleggianti 3/8" <i>1/2" chromate brass tap for 3/8" filling valves</i>	8029954005246
1521-10	Set 10 tappini laterali <i>Set 10 side plugs</i>	8029954008827
1524A-10	Set 10 morsetti per vaso Ø esterno 55/60 Ø interno 40 <i>Set 10 bowl gaskets external Ø 55/60, internal Ø 40</i>	8029954007875
1531E	Tasto singolo con leva <i>Single push button with lever</i>	8029954003600
1532-10	Set 10 dadi per fissaggio meccanismo <i>Set 10 outlet valve nut</i>	8029954008780
1533-10	Set 10 controdadi bianchi per fissaggio tubo Ø 50 <i>Set 10 fixing pipe back nuts Ø 50</i>	8029954008797
1535-10	Set 10 guarnizioni piane base meccanismo <i>Set 10 outlet valve flat gasket</i>	8029954007592
1538-10	Set 10 guarnizioni coniche per tubo Ø 50 <i>Set 10 conical pipe gaskets Ø 50</i>	8029954007878
1540-10	Set 10 guarnizioni di tenuta meccanismo <i>Set 10 outlet valve gaskets</i>	8029954007523
1560	Kit per fissaggio muro <i>Wall fixing kit</i>	8029954003518



Beta

Art. / Item	Descrizione / Models	EAN
1037S	Coperchio completo di pulsante <i>Cover complete with push button</i>	8029954000401
1400B	Meccanismo di scarico con dado e controdado <i>Outlet valve with nut and back nut</i>	8029954003211
1501	Tubo di scarico Ø 50x32 lunghezza mm 346x225 <i>Pipe for wall low-level cistern Ø 50x32 mm 346x225</i>	8029954004034
1520	Galleggiante Blue 3/8" codolo ottone <i>Blue floating valve 3/8" brass tang</i>	8029954003709
1516C	Rubinetto a squadra 1/2" ottone cromato per galleggianti 3/8" <i>1/2" chromate brass tap for 3/8" filling valves</i>	8029954005246
1521-10	Set 10 tappini laterali <i>Set 10 side plugs</i>	8029954008827
1524-10	Set 10 morsetti per vaso Ø esterno 55/60 Ø interno 32 <i>Set 10 bowl gaskets external Ø 55/60, internal Ø 32</i>	8029954007868
1531S	Tasto singolo con leva <i>Single push button with lever</i>	8029954003655
1532-10	Set 10 dadi per fissaggio meccanismo <i>Set 10 outlet valve nut</i>	8029954008780
1533-10	Set 10 controdadi bianchi per fissaggio tubo Ø 50 <i>Set 10 fixing pipe back nuts Ø 50</i>	8029954008797
1535-10	Set 10 guarnizioni piane base meccanismo <i>Set 10 outlet valve flat gasket</i>	8029954007592
1538-10	Set 10 guarnizioni coniche per tubo Ø 50 <i>Set 10 conical pipe gaskets Ø 50</i>	8029954007878
1540-10	Set 10 guarnizioni di tenuta meccanismo <i>Set 10 outlet valve gaskets</i>	8029954007523
1560	Kit per fissaggio muro <i>Wall fixing kit</i>	8029954003518



Export

Art. / Item	Descrizione / Models	EAN
1037	Coperchio completo di pulsante <i>Cover complete with push button</i>	8029954000364
1400B	Meccanismo di scarico con dado e controdado <i>Outlet valve with nut and back nut</i>	8029954003211
1501	Tubo di scarico Ø 50x32 lunghezza mm 346x225 <i>Pipe for wall low-level cistern Ø 50x32 mm 346x225</i>	8029954004034
1516C	Rubinetto a squadra 1/2" ottone cromato per galleggianti 3/8" <i>1/2" chromate brass tap for 3/8" filling valves</i>	8029954005246
1520P	Galleggiante Blue 3/8" codolo plastica <i>Blue floating valve 3/8" pom tang</i>	8029954004300
1521-10	Set 10 tappini laterali <i>Set 10 side plugs</i>	8029954008827
1524-10	Set 10 morsetti per vaso Ø esterno 55/60 Ø interno 32 <i>Set 10 bowl gaskets external Ø 55/60, internal Ø 32</i>	8029954007868
1531A	Tasto singolo con leva <i>Single push button with lever</i>	8029954003563
1532-10	Set 10 dadi per fissaggio meccanismo <i>Set 10 outlet valve nut</i>	8029954008780
1533-10	Set 10 controdadi bianchi per fissaggio tubo Ø 50 <i>Set 10 fixing pipe back nuts Ø 50</i>	8029954008797
1535-10	Set 10 guarnizioni piane base meccanismo <i>Set 10 outlet valve flat gasket</i>	8029954007592
1538-10	Set 10 guarnizioni coniche per tubo Ø 50 <i>Set 10 conical pipe gaskets Ø 50</i>	8029954007878
1540-10	Set 10 guarnizioni di tenuta meccanismo <i>Set 10 outlet valve gaskets</i>	8029954007523
1560	Kit per fissaggio muro <i>Wall fixing kit</i>	8029954003518



Concept
Pneu

Art. / Item	Descrizione / Models	EAN
1007C1	Coperchio completo di pulsante <i>Cover complete with push button</i>	8029954080076
1408G	Meccanismo di scarico pneu con dado e controdado <i>Pneumatic outlet valve with nut and back nut</i>	8029954004416
1501A	Tubo di scarico Ø 50x40 lunghezza mm 350x245 <i>Pipe for wall low-level cistern Ø 50x40 mm 350x245</i>	8029954004041
1510	Galleggiante Rambo 3/8" codolo ottone <i>Rambo floating valve 3/8" brass tang</i>	8029954003709
1516C	Rubinetto a squadra 1/2" ottone cromato per galleggianti 3/8" <i>1/2" chromate brass tap for 3/8" filling valves</i>	8029954005246
1521-10	Set 10 tappini laterali <i>Set 10 side plugs</i>	8029954008827
1523-10	Set 10 morsetti per vaso Ø esterno 48/50 Ø interno 32 <i>Set 10 bowl gaskets external Ø 48/50, internal Ø 32</i>	8029954007844
1524A-10	Set 10 morsetti per vaso Ø esterno 55/60 Ø interno 40 <i>Set 10 bowl gaskets external Ø 55/60, internal Ø 40</i>	8029954007875
1531R3	Gruppo ponte con leve Concept 1 <i>Bridge with levers for Concept 1</i>	8029954080205
1532-10	Set 10 dadi per fissaggio meccanismo <i>Set 10 outlet valve nut</i>	8029954008780
1533-10	Set 10 controdadi bianchi per fissaggio tubo Ø 50 <i>Set 10 fixing pipe back nuts Ø 50</i>	8029954008797
1535-10	Set 10 guarnizioni piane base meccanismo <i>Set 10 outlet valve flat gasket</i>	8029954007592
1538-10	Set 10 guarnizioni coniche per tubo Ø 50 <i>Set 10 conical pipe gaskets Ø 50</i>	8029954007878
1540-10	Set 10 guarnizioni di tenuta meccanismo <i>Set 10 outlet valve gaskets</i>	8029954007523
1560	Kit per fissaggio muro <i>Wall fixing kit</i>	8029954003518
PE	Pulsante esterno completo di tubetto e canalina <i>External push-button complete with pipe and tube</i>	8029954004324
PI	Pulsante incasso completo di tubetto e guaina <i>External push-button complete with pipe and sheath</i>	8029954004331



Concept
Monoblock
1

Art. / Item	Descrizione / Models	EAN
1007C1	Coperchio completo di pulsante per Concept 1 <i>Cover complete with push button for wc cistern Concept 1</i>	8029954080076
1400G	Meccanismo di scarico con dado e controdado <i>Outlet valve with nut and back nut</i>	8029954080229
1510	Galleggiante Rambo 3/8" codolo ottone <i>Rambo floating valve 3/8" brass tang</i>	8029954003709
1516C	Rubinetto a squadra 1/2" ottone cromato per galleggianti 3/8" <i>1/2" chromate brass tap for 3/8" filling valves</i>	8029954005246
1521-10	Set 10 tappini laterali <i>Set 10 side plugs</i>	8029954008827
1526QF	Kit per fissaggio cassetta su vaso wc <i>Bowl fixing kit</i>	8029954005253
1527/02	Guarnizione in mousse epdm <i>Mousse epdm rubber gasket</i>	8029954049684
1531R3	Gruppo ponte con leve Concept 1 <i>Bridge with levers for Concept 1</i>	8029954080205
1532-10	Set 10 dadi per fissaggio meccanismo <i>Set 10 outlet valve nut</i>	8029954008780
1533-10	Set 10 controdadi bianchi per fissaggio tubo Ø 50 <i>Set 10 fixing pipe back nuts Ø 50</i>	8029954008797
1535-10	Set 10 guarnizioni piane base meccanismo <i>Set 10 outlet valve flat gasket</i>	8029954007592
1540-10	Set 10 guarnizioni di tenuta meccanismo <i>Set 10 outlet valve gaskets</i>	8029954007523



Concept Monoblock 2

Art. / Item	Descrizione / Models	EAN
1007C2	Coperchio completo di pulsante per Concept 2 <i>Cover complete with push button for wc cistern Concept 2</i>	8029954080083
1400C	Meccanismo di scarico con dado e controdado <i>Outlet valve with nut and back nut</i>	8029954003228
1510	Galleggiante Rambo 3/8" codolo ottone <i>Rambo floating valve 3/8" brass tang</i>	8029954003709
1516C	Rubinetto a squadra 1/2" ottone cromato per galleggianti 3/8" <i>1/2" chromate brass tap for 3/8" filling valves</i>	8029954005246
1521-10	Set 10 tappini laterali <i>Set 10 side plugs</i>	8029954008827
1526QF	Kit per fissaggio cassetta su vaso wc <i>Bowl fixing kit</i>	8029954005253
1527/02	Guarnizione in mousse epdm <i>Mousse epdm rubber gasket</i>	8029954049684
1531R4	Gruppo ponte con leve Concept 2 <i>Bridge with levers for Concept 2</i>	8029954080212
1532-10	Set 10 dadi per fissaggio meccanismo <i>Set 10 outlet valve nut</i>	8029954008780
1533-10	Set 10 controdadi bianchi per fissaggio tubo Ø 50 <i>Set 10 fixing pipe back nuts Ø 50</i>	8029954008797
1535-10	Set 10 guarnizioni piane base meccanismo <i>Set 10 outlet valve flat gasket</i>	8029954007592
1540-10	Set 10 guarnizioni di tenuta meccanismo <i>Set 10 outlet valve gaskets</i>	8029954007523



Polo

Art. / Item	Descrizione / Models	EAN
1077	Coperchio <i>Cover</i>	8029954000951
1400B	Meccanismo di scarico con dado e controdado <i>Outlet valve with nut and back nut</i>	8029954003211
1501B	Tubo di scarico Ø 50x44 lunghezza mm 346x225 <i>Pipe for wall low-level cistern Ø 50x44 mm 346x225</i>	8029954004058
1520	Galleggiante Blue 3/8" codolo ottone <i>Blue floating valve 3/8" brass tang</i>	8029954003709
1516C	Rubinetto a squadra 1/2" ottone cromato per galleggianti 3/8" <i>1/2" chromate brass tap for 3/8" filling valves</i>	8029954005246
1521-10	Set 10 tappini laterali <i>Set 10 side plugs</i>	8029954008827
1524B-10	Set 10 morsetti per vaso Ø esterno 55/60 Ø interno 44 <i>Set 10 bowl gaskets external Ø 55/60, internal Ø 44</i>	8029954007882
1531D	Tasto singolo con leva <i>Single push button with lever</i>	8029954003594
1532-10	Set 10 dadi per fissaggio meccanismo <i>Set 10 outlet valve nut</i>	8029954008780
1533-10	Set 10 controdadi bianchi per fissaggio tubo Ø 50 <i>Set 10 fixing pipe back nuts Ø 50</i>	8029954008797
1535-10	Set 10 guarnizioni piane base meccanismo <i>Set 10 outlet valve flat gasket</i>	8029954007592
1538-10	Set 10 guarnizioni coniche per tubo Ø 50 <i>Set 10 conical pipe gaskets Ø 50</i>	8029954007878
1540-10	Set 10 guarnizioni di tenuta meccanismo <i>Set 10 outlet valve gaskets</i>	8029954007523
1560	Kit per fissaggio muro <i>Wall fixing kit</i>	8029954003518



Concept
Alta

Art. / Item	Descrizione / Models	EAN
1007C1	Coperchio completo di pulsante <i>Cover complete with push button</i>	8029954080076
1400G	Meccanismo di scarico con dado e controdado <i>Outlet valve with nut and back nut</i>	8029954080229
1510	Galleggiante Rambo 3/8" codolo ottone <i>Rambo floating valve 3/8" brass tang</i>	8029954003709
1516C	Rubinetto a squadra 1/2" ottone cromato per galleggianti 3/8" <i>1/2" chromate brass tap for 3/8" filling valves</i>	8029954005246
1521-10	Set 10 tappini laterali <i>Set 10 side plugs</i>	8029954008827
1522A-10	Set 10 pull a perlina <i>Set 10 metal pull chain</i>	8029954008841
1523-10	Set 10 morsetti per vaso Ø esterno 48/50 Ø interno 32 <i>Set 10 bowl gaskets external Ø 48/50, internal Ø 32</i>	8029954007844
1531-10	Set 10 leve per cassetta alta <i>Set 10 levers for high level cistern</i>	8029954008391
1531R3	Gruppo ponte con leve Concept 1 <i>Bridge with levers for Concept 1</i>	8029954080205
1532-10	Set 10 dadi per fissaggio meccanismo <i>Set 10 outlet valve nut</i>	8029954008780
1533-10	Set 10 controdadi bianchi per fissaggio tubo Ø 50 <i>Set 10 fixing pipe back nuts Ø 50</i>	8029954008797
1535-10	Set 10 guarnizioni piane base meccanismo <i>Set 10 outlet valve flat gasket</i>	8029954007592
1540-10	Set 10 guarnizioni di tenuta meccanismo <i>Set 10 outlet valve gaskets</i>	8029954007523
1560	Kit per fissaggio muro <i>Wall fixing kit</i>	8029954003518



Angolo

Art. / Item	Descrizione / Models	EAN
1057	Coperchio completo di pulsante <i>Cover complete with push button</i>	8029954000708
1400B	Meccanismo di scarico con dado e controdado <i>Outlet valve with nut and back nut</i>	8029954003211
1501A	Tubo di scarico Ø 50x40 lunghezza mm 350x245 <i>Pipe for wall low-level cistern Ø 50x40 mm 350x245</i>	8029954004041
1510	Galleggiante Rambo 3/8" codolo ottone <i>Rambo floating valve 3/8" brass tang</i>	8029954003709
1516C	Rubinetto a squadra 1/2" ottone cromato per galleggianti 3/8" <i>1/2" chromate brass tap for 3/8" filling valves</i>	8029954005246
1521-10	Set 10 tappini laterali <i>Set 10 side plugs</i>	8029954008827
1524A-10	Set 10 morsetti per vaso Ø esterno 55/60 Ø interno 40 <i>Set 10 bowl gaskets external Ø 55/60, internal Ø 40</i>	8029954007875
1531A	Tasto singolo con leva <i>Single push button with lever</i>	8029954003563
1532-10	Set 10 dadi per fissaggio meccanismo <i>Set 10 outlet valve nut</i>	8029954008780
1533-10	Set 10 controdadi bianchi per fissaggio tubo Ø 50 <i>Set 10 fixing pipe back nuts Ø 50</i>	8029954008797
1535-10	Set 10 guarnizioni piane base meccanismo <i>Set 10 outlet valve flat gasket</i>	8029954007592
1538-10	Set 10 guarnizioni coniche per tubo Ø 50 <i>Set 10 conical pipe gaskets Ø 50</i>	8029954007878
1540-10	Set 10 guarnizioni di tenuta meccanismo <i>Set 10 outlet valve gaskets</i>	8029954007523
1560	Kit per fissaggio muro <i>Wall fixing kit</i>	8029954003518



Alfa

Art. / Item	Descrizione / Models	EAN
1042	Coperchio <i>Cover</i>	8029954000470
1401A	Meccanismo di scarico con dado e controdado <i>Outlet valve with nut and back nut</i>	8029954003242
1516C	Rubinetto a squadra 1/2" ottone cromato per galleggianti 3/8" <i>1/2" chromate brass tap for 3/8" filling valves</i>	8029954005246
1520	Galleggiante Blue 3/8" codolo ottone <i>Blue floating valve 3/8" brass tang</i>	8029954004270
1521-10	Set 10 tappini laterali <i>Set 10 side plugs</i>	8029954008827
1522-10	Set 10 pull a cordina <i>Set 10 rope pull</i>	8029954008834
1531-10	Set 10 leve per cassetta alta <i>Set 10 levers for high level cistern</i>	8029954008391
1532A-10	Set 10 dadi per fissaggio meccanismo <i>Set 10 outlet valve nut</i>	8029954008803
1533A-10	Set 10 controdadi bianchi per fissaggio tubo Ø 32 <i>Set 10 fixing pipe back nut Ø 32</i>	8029954008810
1536-10	Set 10 guarnizioni piane base meccanismo <i>Set 10 outlet valve flat gasket</i>	8029954007585
1540-10	Set 10 guarnizioni di tenuta meccanismo <i>Set 10 outlet valve gaskets</i>	8029954007523
1560	Kit per fissaggio muro <i>Wall fixing kit</i>	8029954003518
G4-10	Set 10 guarnizioni coniche per tubo Ø 32 <i>Set 10 conical pipe gaskets Ø 32</i>	8029954008292



Cabrio

Art. / Item	Descrizione / Models	EAN
1401C	Meccanismo di scarico con dado e controdado <i>Outlet valve with nut and back nut</i>	8029954003280
1516C	Rubinetto a squadra 1/2" ottone cromato per galleggianti 3/8" <i>1/2" chromate brass tap for 3/8" filling valves</i>	8029954005246
1520P	Galleggiante Blue 3/8" codolo plastica <i>Blue floating valve 3/8" pom tang</i>	8029954004300
1521-10	Set 10 tappini laterali <i>Set 10 side plugs</i>	8029954008827
1522-10	Set 10 pull a cordina <i>Set 10 rope pull</i>	8029954008834
1531-10	Set 10 leve per cassetta alta <i>Set 10 levers for high level cistern</i>	8029954008391
1532A-10	Set 10 dadi per fissaggio meccanismo <i>Set 10 outlet valve nut</i>	8029954008803
1533A-10	Set 10 controdadi bianchi per fissaggio tubo Ø 32 <i>Set 10 fixing pipe back nut Ø 32</i>	8029954008810
1536-10	Set 10 guarnizioni piane base meccanismo <i>Set 10 outlet valve flat gasket</i>	8029954007585
1540-10	Set 10 guarnizioni di tenuta meccanismo <i>Set 10 outlet valve gaskets</i>	8029954007523
G4-10	Set 10 guarnizioni coniche per tubo Ø 32 <i>Set 10 conical pipe gaskets Ø 32</i>	8029954008292

LEGENDA



Tasto economizzatore d'acqua start/stop
Single button with water-saving start/stop



Doppio scarico regolabile
Adjustable double flush



Possibilità di azionamento da remoto
Possibility to remote functioning



Isolamento anticondensa
Insulation against condensation



Risparmio acqua
Water saving



Facile accesso ai componenti interni
Easy access to internal components



Funzionamento silenzioso
Silent functioning



Montaggio semplice e veloce
Easy and fast mounting

CASSETTE INCASSO BUILT-IN WC CISTERNS

**Il perfetto connubio tra semplicità di installazione,
funzionalità e facilità di manutenzione**

*The perfect combination of easy installation, functionality
and easy maintenance*



FUSION

Cassetta da incasso per wc a pavimento - Concealed cistern for floor standing wc



Tipo di applicazione

- Installazione ad incasso in pareti di muratura

Caratteristiche tecniche

- Profondità 90 mm
- Comando frontale di attivazione scarico
- Capacità 7 litri con possibilità di regolazione
- Compatibile con placche 1 tasto e 2 tasti
- Doppio scarico regolabile
- Allacciamento rete idrica 1/2" in alto
- Isolamento anticondensa
- Rete per intonaco
- **Disponibile anche in versione pneumatica**
- Completa di materiale di fissaggio
- Placca di attivazione da ordinare separatamente

Field of application

- Built-in installation in masonry walls

Technical features

- Depth 90 mm
- Frontal flushing activation
- 7 liters capacity with the possibility to adjust the amount of water
- Compatible with plates 1 button and 2 buttons
- Adjustable double flush
- Connection 1/2" to mains water supply on top
- Insulation against condensation
- Plaster net
- **Also available in pneumatic version**
- Complete with fixing material
- Flushing plate needs to be ordered separately



Art. / Item

Descrizione / Models

EAN

Art. / Item	Descrizione / Models	EAN
1060F	FUSION incasso per installazione in muratura con vaso a pavimento <i>FUSION built-in for in-wall installation with floor standing wc bowls</i>	8029954005918
1060FP	FUSION incasso per installazione in muratura con vaso a pavimento, funzionamento pneumatico <i>FUSION built-in for in-wall installation with floor standing wc bowls, pneumatic functioning</i>	8029954005482

Equipaggiamento - Equipment

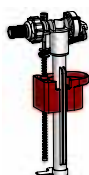

Galleggiante 3/8"
Nanotek, codolo ottone
*Filling valve Nanotek,
with 3/8" brass tang*

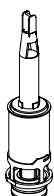

Meccanismo di scarico
Flushing valve



Tubo coibentato
Insulate pipe

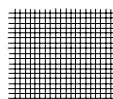

Rete per intonaco
Plaster net



Isolamento anti-condensa
Anti-condensation insulation

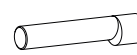

Canotto eccentrico collegamento al wc
Eccentric dinghy connection to wc



Placca
Plate



Pulsante pneumatico
Pneumatic push-button

1060F	✓	✓	✓	✓	✓	✓
1060FP	✓	✓	✓	✓	✓	✓

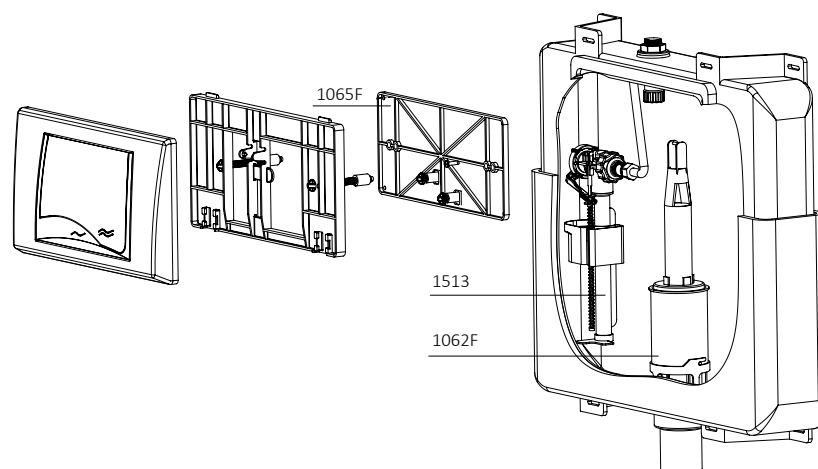





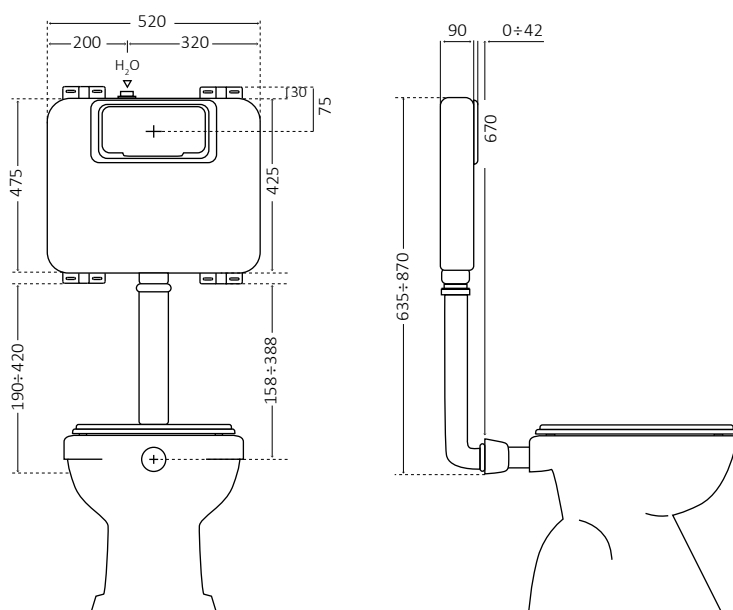
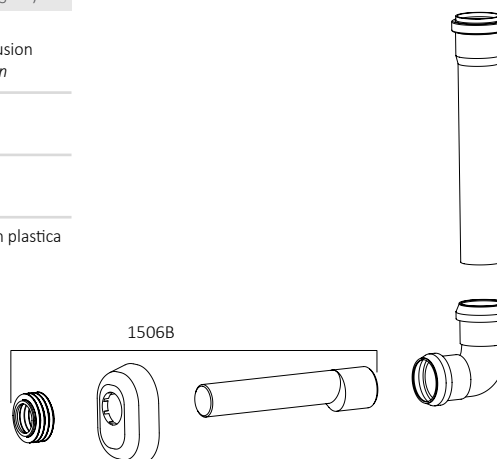

Ricambi - Spare parts (Dettagli a pag.75 - Details pag.75)

- | | |
|-------|---|
| 1062F | Meccanismo di scarico con sede estraibile per cassetta Fusion
<i>Flush valve with extractable lower part for "Fusion" cistern</i> |
| 1065F | Placca porta-leverismi per cassetta Fusion
<i>Back-plate with lever-system for "Fusion" cistern</i> |
| 1506B | Cannotto eccentrico, rosone e morsetto
<i>Eccentric pipe, rosette and bowl gasket</i> |
| 1513 | Galleggiante NANOTEK 3/8" codolo ottone per cassette in plastica
<i>Filling valve NANOTEK 3/8" brass tang for plastic cisterns</i> |



Info packing

 Dimensioni imballo singolo <i>Single box dimensions</i>	54x17x52,5	
 Peso imballo singolo <i>Weight single box</i>	1060F	3,15
	1060FP	3,50
 N° scatole singole su pallet <i>N° single box on a pallet</i>	27	
 Dimensioni pallet <i>Pallet dimensions</i>	80x120x180	
 N° scatole singole in cartone master <i>N° single box in a master box</i>	-	
 Dimensioni cartone master <i>Master box dimensions</i>	-	

FUSION

Modulo per wc sospeso - Module for wall hung pan



Tipo di applicazione

- Installazione ad incasso in pareti di muratura o davanti parete

Caratteristiche tecniche

- Profondità 92 mm
- Telaio di supporto wc sospeso con cassetta pre-assemblata
- Comando frontale di attivazione scarico
- Capacità 7 litri con possibilità di regolazione
- Compatibile con placche 1 tasto e 2 tasti
- Doppio scarico regolabile
- Allacciamento rete idrica 1/2" in alto
- Isolamento anticondensa
- Rete per intonaco
- Completa di materiale di fissaggio
- Placca di attivazione da ordinare separatamente

Field of application

- Installation on or in masonry walls

Technical features

- Depth 92 mm
- Supporting frame for wc pan with pre-assembled cistern
- Frontal flushing activation
- 7 liters capacity with the possibility to adjust the amount of water
- Compatible with plates 1 button and 2 buttons
- Adjustable double flush
- Connection 1/2" to mains water supply on top
- Insulation against condensation
- Plaster net
- Complete with fixing material
- Flushing plate needs to be ordered separately



Art. / Item

Descrizione / Models

EAN

1060FU	FUSION incasso per installazione in muratura con vaso sospeso FUSION built-in for in-wall installation with wall-hung wc bowl	8029954005925
--------	--	---------------

Equipaggiamento - Equipment



Galleggiante 3/8"
Nanotek, codolo ottone
Filling valve Nanotek,
with 3/8" brass tang

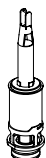

Meccanismo
di scarico
Flushing valve



Tubo di scarico
Outlet pipe

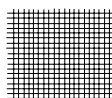

Rete per
intonaco
Plaster net

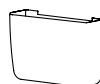

Isolamento
anti-condensa
Anti-condensa-
tion insulation



Canotto concentrico
collegamento al wc
Concentric dinghy
connection to wc

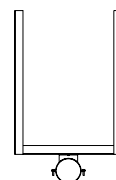

Struttura per
vaso sospeso
Module for
wall hung pan



Curva di
scarico wc
Curve for
wc outlet



Placca
Plate

1060FU	✓	✓	✓	✓	✓	✓	✓	✓
--------	---	---	---	---	---	---	---	---

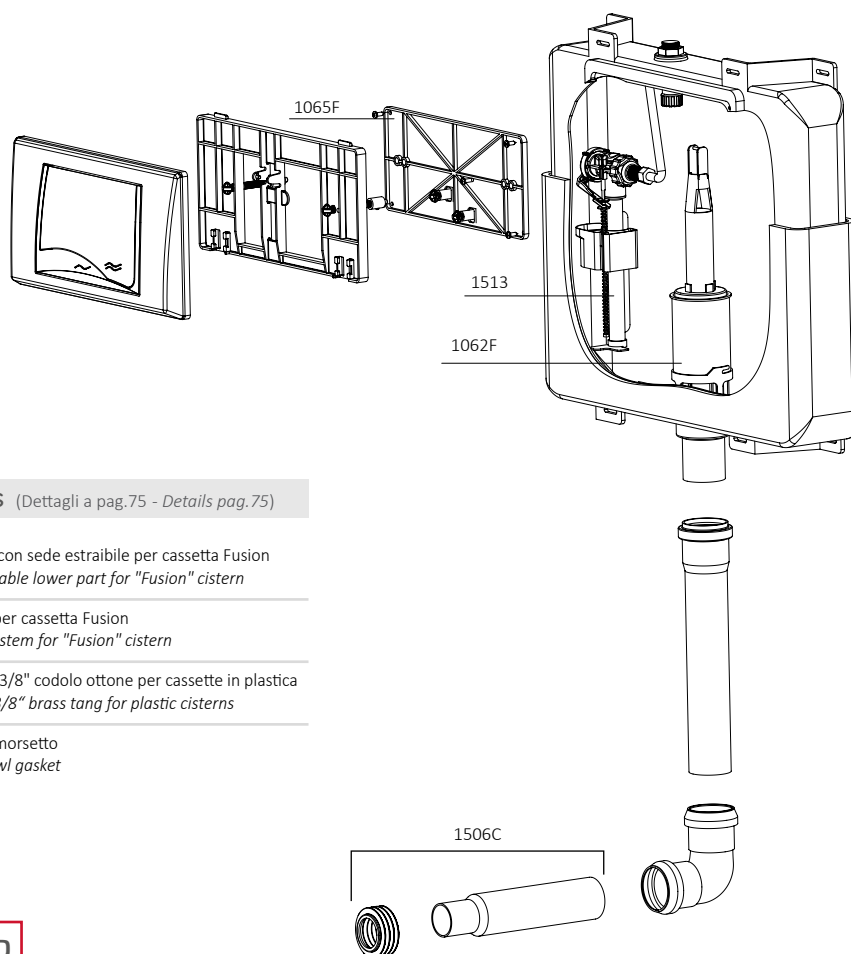





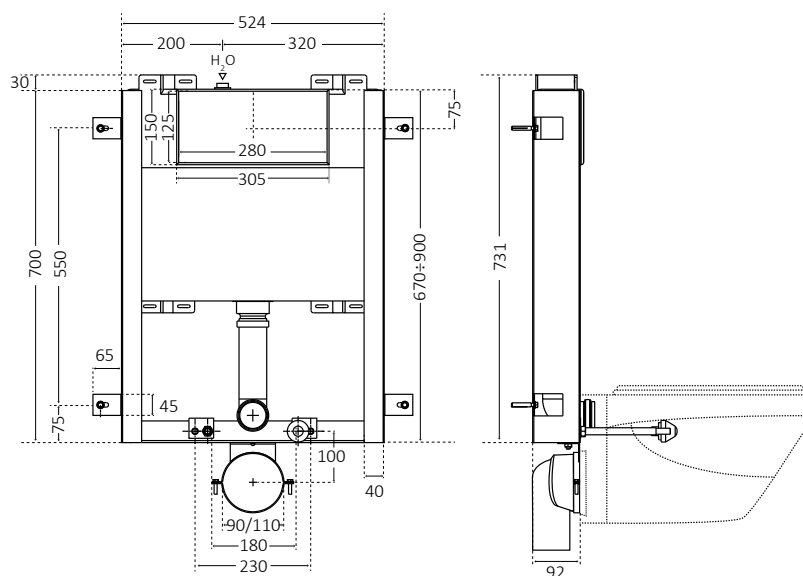

Ricambi - Spare parts (Dettagli a pag.75 - Details pag.75)

1062F	Meccanismo di scarico con sede estraibile per cassetta Fusion <i>Flush valve with extractable lower part for "Fusion" cistern</i>
1065F	Placca porta-leverismi per cassetta Fusion <i>Back-plate with lever-system for "Fusion" cistern</i>
1513	Galleggiante NANOTEK 3/8" codolo ottone per cassette in plastica <i>Filling valve NANOTEK 3/8" brass tang for plastic cisterns</i>
1506C	Canotto concentrico e morsetto <i>Concentric pipe and bowl gasket</i>



Info packing

 Dimensioni imballo singolo <i>Single box dimensions</i>	76,5x20x55
 Peso imballo singolo <i>Weight single box</i>	8,62
 N° scatole singole su pallet <i>N° single box on a pallet</i>	22
 Dimensioni pallet <i>Pallet dimensions</i>	80x120x235
 N° scatole singole in cartone master <i>N° single box in a master box</i>	-
 Dimensioni cartone master <i>Master box dimensions</i>	-

FUSION

Modulo autoportante per wc sospeso - Self supporting module for wall-hung pan



Tipo di applicazione

- Installazione in pareti prefabbricate, in cartongesso o in muratura

Caratteristiche tecniche

- Profondità 90 mm
- Telaio autoportante per wc sospeso con cassetta pre-assemblata
- Comando frontale di attivazione scarico
- Capacità 7 litri con possibilità di regolazione
- Compatibile con placche 1 tasto e 2 tasti
- Doppio scarico regolabile
- Allacciamento rete idrica 1/2" in alto
- Isolamento anticondensa
- Rete per intonaco
- Completa di materiale di fissaggio
- Placca di attivazione da ordinare separatamente

Field of application

- Installation in prefabricated walls, pre-wall installation on dry walls, universal installation in masonry walls

Technical features

- Depth 90 mm
- Self-supporting frame for wc pan with pre-assembled cistern
- Frontal flushing activation
- 7 liters capacity with the possibility to adjust the amount of water
- Compatible with plates 1 button and 2 buttons
- Adjustable double flush
- Connection 1/2" to mains water supply on top
- Insulation against condensation
- Plaster net
- Complete with fixing material
- Flushing plate needs to be ordered separately



Art. / Item

Descrizione / Models

EAN

1060FA

FUSION incasso per installazione universale con vaso sospeso
FUSION built-in for universal installation with wall-hung wc bowl

8029954005741

Equipaggiamento - Equipment



Galleggiante 3/8"
Nanotek, codolo ottone
Filling valve Nanotek,
with 3/8" brass tang

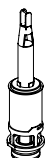

Meccanismo
di scarico
Flushing valve



Tubo di scarico
Outlet pipe

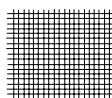

Rete per
intonaco
Plaster net



Isolamento
anti-condensa
Anti-condensa-
tion insulation



Canotto concentrico
collegamento al wc
Concentric dinghy
connection to wc

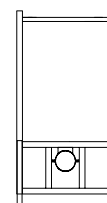

Struttura per
vaso sospeso
Module for
wall hung pan



Curva di
scarico wc
Curve for
wc outlet



Placca
Plate

1060FA



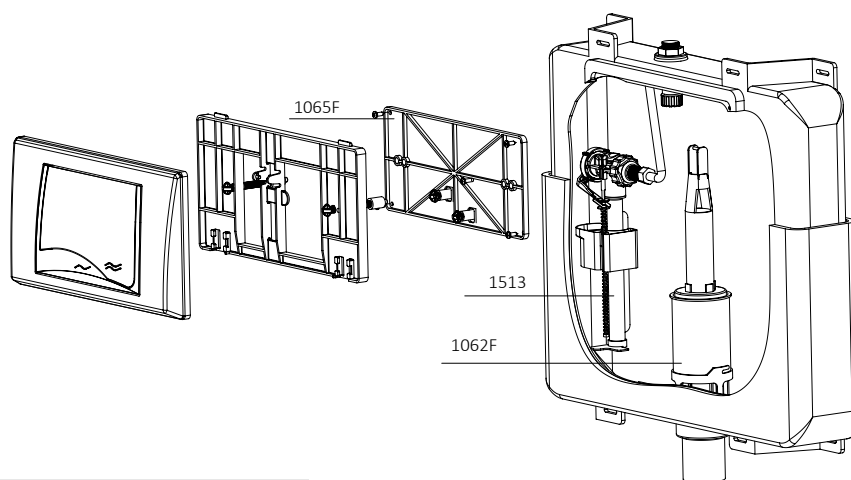





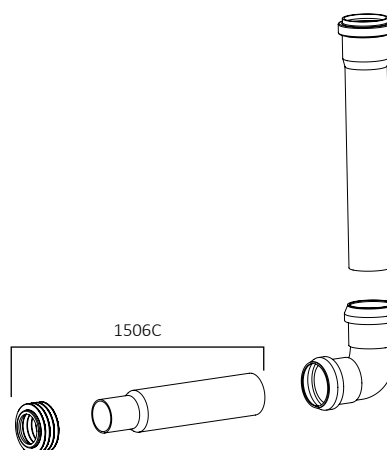

Ricambi - Spare parts (Dettagli a pag.75 - Details pag.75)

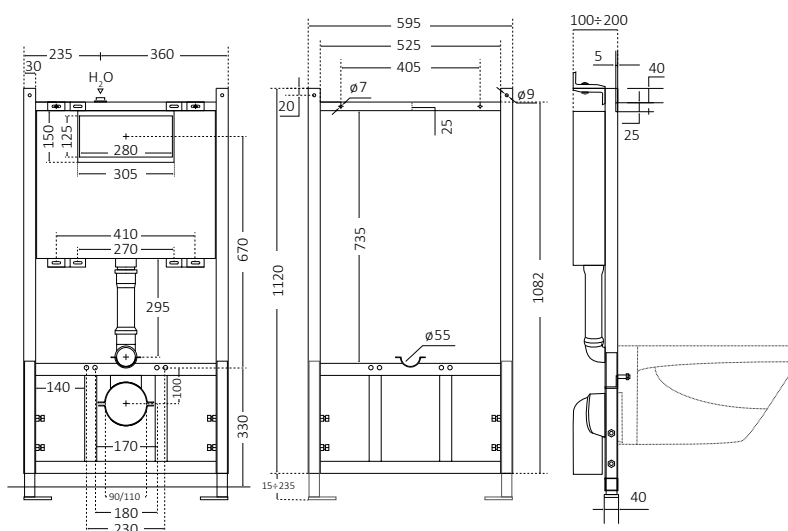
1062F	Meccanismo di scarico con sede estraibile per cassetta Fusion <i>Flush valve with extractable lower part for "Fusion" cistern</i>
1065F	Placca porta-leverismi per cassetta Fusion <i>Back-plate with lever-system for "Fusion" cistern</i>
1513	Galleggiante NANOTEK 3/8" codolo ottone per cassette in plastica <i>Filling valve NANOTEK 3/8" brass tang for plastic cisterns</i>
1506C	Canotto concentrico e morsetto <i>Concentric pipe and bowl gasket</i>



Info packing



 Dimensioni imballo singolo <i>Single box dimensions</i>	116x20x64
 Peso imballo singolo <i>Weight single box</i>	13,54
 N° scatole singole su pallet <i>N° single box on a pallet</i>	12
 Dimensioni pallet <i>Pallet dimensions</i>	80x120x210
 N° scatole singole in cartone master <i>N° single box in a master box</i>	-
 Dimensioni cartone master <i>Master box dimensions</i>	-

PLACCHE

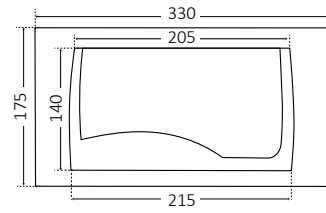



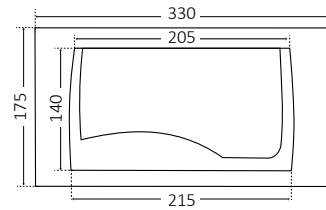



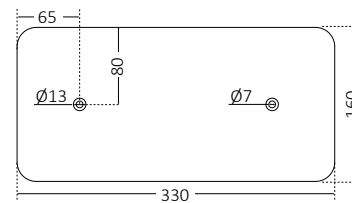

Art. / Item	Descrizione / Models	Dimensioni imballo singolo Single box dimensions	Peso imballo singolo Single box weight	EAN
1061B2	Placca bianca a due tasti <i>White plate double flush</i>	36x5x19	0,6	8029954005611



Art. / Item	Descrizione / Models	Dimensioni imballo singolo Single box dimensions	Peso imballo singolo Single box weight	EAN
1061C2	Placca cromata a due tasti <i>Chromed plate double flush</i>	36x5x19	0,6	8029954005734



Art. / Item	Descrizione / Models	Dimensioni imballo singolo Single box dimensions	Peso imballo singolo Single box weight	EAN
1061P	Placca di copertura inox per Fusion pneumatica <i>Stainless steel covering plate for pneumatic Fusion</i>	36x5x19	1,5	8029954005475

	Art. / Item	Descrizione / Models	EAN
	PI	Pulsante incasso completo di tubetto e guaina flessibile <i>Built-in push-button complete with pipe and flexible sheath</i>	8029954004331
	PIC	Pulsante incasso cromato completo di tubetto e guaina flessibile <i>Chromed external push-button complete with pipe and flexible sheath</i>	8029954004447
	PPI	Pulsante incasso a pedale completo di tubetto e guaina flessibile <i>Built-in foot push-button complete with pipe and flexible sheath</i>	8029954004355
	1062F	Meccanismo di scarico con sede estraibile per cassetta Fusion <i>Flush valve with extractable lower part for "Fusion" cistern</i>	8029954005772
	1063F	Guarnizione di tenuta per meccanismo di scarico Fusion <i>Gasket for "Fusion" cistern flush valve</i>	8029954005789
	1506B	Cannotto eccentrico, rosone e morsetto <i>Eccentric pipe, rosette and bowl gasket</i>	8029954004003
	1065F	Placca porta-leverismi per cassetta Fusion <i>Back-plate with lever-system for "Fusion" cistern</i>	8029954005802
	1513	Galleggiante NANOTEK 3/8" codolo ottone per cassette in plastica <i>Filling valve NANOTEK 3/8" brass tang for plastic cisterns</i>	8029954073474

LEGENDA

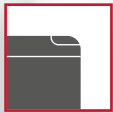

Adatto a cassette esterne
Suitable for external wc cisterns



Adatto a cassette incasso
Suitable for built-in wc cisterns

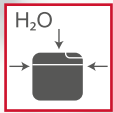

Attacco idrico laterale o posteriore centrale
Side or back water connection



Attacco idrico inferiore
Lower water connection



Performante anche a basse pressioni
Good performance also with low pressure

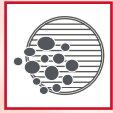

Filtro anti-impurità
Anti-impurity filter



Regolabile in altezza
Adjustable height



Funzionamento silenzioso
Silent functioning



Conforme alla normativa CE EN 14124
Comply to CE standard EN 14124



Montaggio semplice e veloce
Easy and fast mounting

GALLEGGIANTI FILLING VALVES

Tecnica, potenza e affidabilità: alla base della gamma di valvole di riempimento CR compatibili con cassette wc di ogni tipo

Technique, power and reliability: at the base of the range of CR filling valves compatible with all types of wc-cisterns



YOUR SMART
SOLUTION



NANOTEK

Attacco laterale - Side entry



PROFESSIONAL
Line

Caratteristiche tecniche - Technical features

Funzionamento: <i>Functioning:</i>	Contropressione Counterpressure
Attacco idrico: <i>Water connection:</i>	Laterale Side
Intervallo di regolazione altezza acqua: <i>Water level adjustment range:</i>	116 mm
Rumorosità con pressione a 3 bar: <i>Noise level with a water pressure of 3 bar:</i>	1° class (<20 decibel) <small>Conforme allo standard CE UNI EN 14124 in accordo con le condizioni del test di UNI EN 3822-1 Comply with CE standard UNI EN 14124 according to test conditions of UNI EN 3822-1</small>
Portata acqua a 3 bar: <i>Water flow at 3 bar:</i>	0,13 l/sec
Pressione statica massima: <i>Max. static pressure:</i>	16 bar
Funzionamento con pressione dinamica: <i>Functioning with dynamic pressure:</i>	0,5 ÷ 10 bar
Conforme alla normativa CE: <i>Comply with CE standard:</i>	UNI EN 14124

DOWNLOAD
Vedi scheda tecnica
View technical sheet

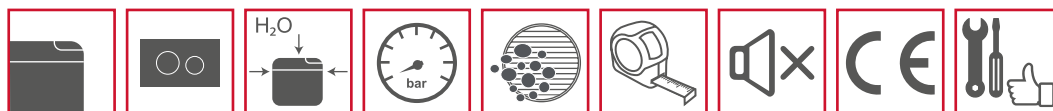

- Ampia regolazione
- Dimensioni ridotte per adattarsi a tutte le situazioni
- Valvola di non ritorno
- Dotato di silenziatore acustico per ridurre l'impatto sonoro
- Filtro anti-impurità facilmente pulibile
- Adatto come ricambio universale per cassette wc esterne e incasso

- Wide range of adjustment
- Small size to adapt to all situation
- Back-flow prevention-valve
- Equipped with acoustic silencer for effective noise reduction
- Impurity filter easily inspectionable
- Suitable for exposed and concealed wc cisterns

Art. / Item	Descrizione / Models	Fornito con adattatore Supplied with adapter	EAN
1513	Galleggiante NANOTEK 3/8" codolo ottone per cassette in plastica <i>Filling valve NANOTEK 3/8" brass tang for plastic cisterns</i>	G	8029954073474
1513IT	Galleggiante NANOTEK 3/8" codolo ottone per cassette in plastica <i>Filling valve NANOTEK 3/8" brass tang for plastic cisterns</i>	G P	8029954073467
1513L	Galleggiante NANOTEK 3/8" codolo ottone lungo per cassette in plastica e porcellana <i>Filling valve NANOTEK 3/8" long brass tang for plastic and vitreous china cisterns</i>	G	8029954073481
1513AP	Galleggiante NANOTEK 1/2" codolo lungo in resina acetaleica per cassette in plastica e porcellana <i>Filling valve NANOTEK 1/2" long pom tang for plastic and vitreous china cisterns</i>	-	8029954073504
1513A	Galleggiante NANOTEK 1/2" codolo lungo in ottone per cassette in plastica e porcellana <i>Filling valve NANOTEK 1/2" long brass tang for plastic and vitreous china cisterns</i>	-	8029954073511

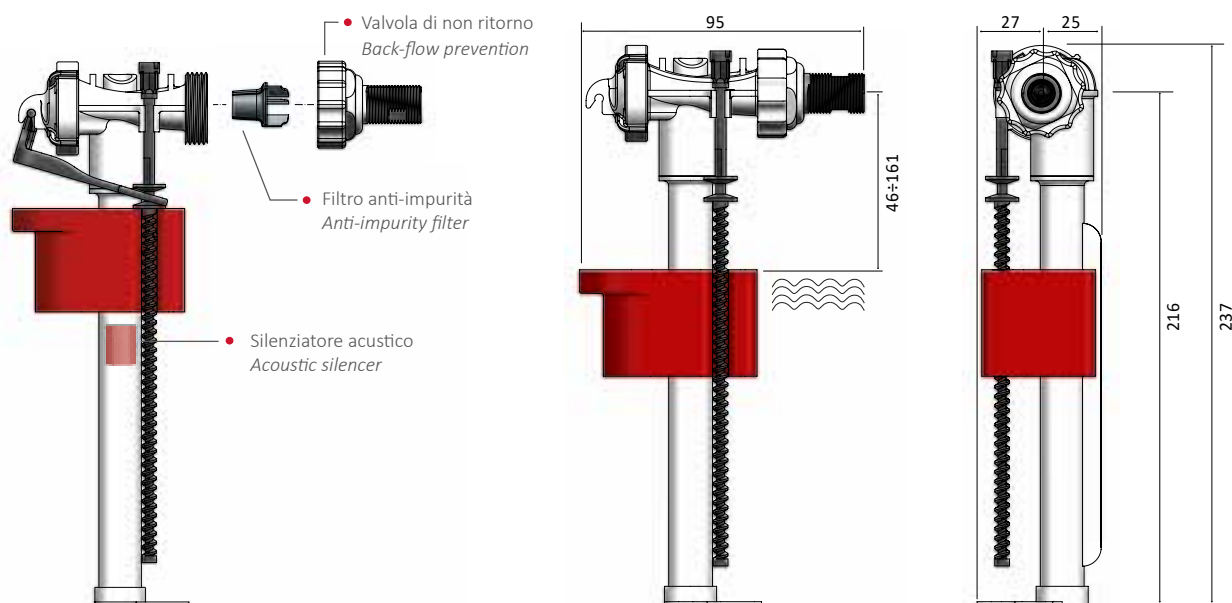

MASSIMA COMPATIBILITA' - MAXIMUM COMPATIBILITY

Grazie ai nostri speciali adattatori è possibile installare il galleggiante anche all'interno di cassette di altri produttori.

Thanks to our special adapters it is possible to install the filling valve also inside wc cisterns of other manufacturers.

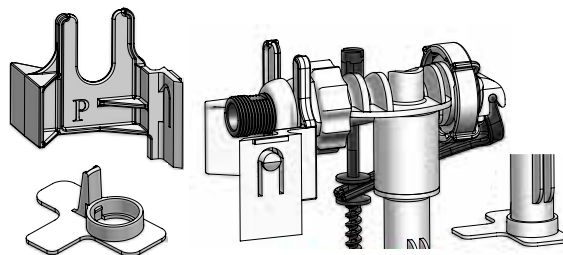
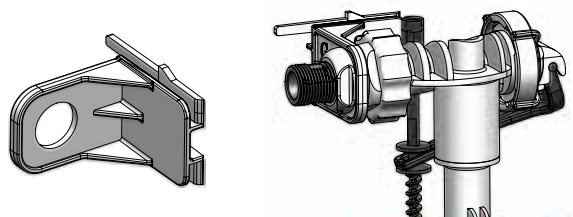







G Adattatore per cassetta incasso Geberit mod. Sigma
Adapter for wc built-in cistern Geberit mod. Sigma

P Adattatore per cassetta incasso Pucci mod. Sara
Adapter for wc built-in cistern Pucci mod. Sara



Info packing

 Dimensioni imballo singolo Single box dimensions	13,5x5,5x25
 Peso imballo singolo Weight single box	0,20
 N° scatole singole in cartone master N° single box in a master box	14
 Dimensioni cartone master Master box dimensions	40x28,5x26,5
 N° cartoni master su pallet N° master box on a pallet	64
 Dimensioni pallet Pallet dimensions	80x120x227

NANOTEK

Attacco basso - Bottom entry



PROFESSIONAL
Line

Caratteristiche tecniche - Technical features

Funzionamento: <i>Functioning:</i>	Contropressione Counterpressure
Attacco idrico: <i>Water connection:</i>	Basso Bottom
Intervallo di regolazione altezza acqua: <i>Water level adjustment range:</i>	140 mm
Rumorosità con pressione a 3 bar: <i>Noise level with a water pressure of 3 bar:</i>	1° class (<20 decibel) <small>Conforme allo standard CE UNI EN 14124 in accordo con le condizioni del test di UNI EN 3822-1 Comply with CE standard UNI EN 14124 according to test conditions of UNI EN 3822-1</small>
Portata acqua a 3 bar: <i>Water flow at 3 bar:</i>	0,13 l/sec
Pressione statica massima: <i>Max. static pressure:</i>	16 bar
Funzionamento con pressione dinamica: <i>Functioning with dynamic pressure:</i>	0,5 ÷ 10 bar
Conforme alla normativa CE: <i>Comply with CE standard:</i>	UNI EN 14124



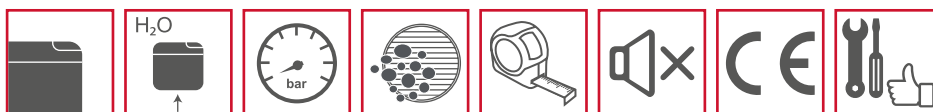

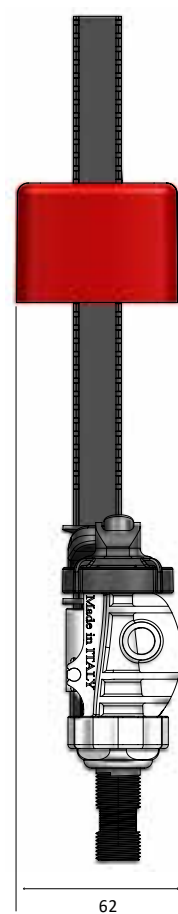
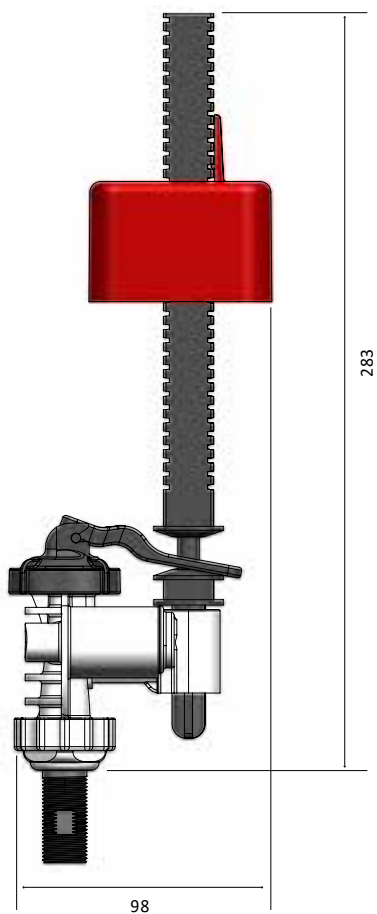

DOWNLOAD
Vedi scheda tecnica
View technical sheet



Art. / Item	Descrizione / Models	EAN
1514L	Galleggiante attacco basso NANOTEK 3/8" codolo ottone con ghiera girevole per cassette in plastica e porcellana <i>Bottom entry filling valve NANOTEK 3/8" brass tang with rotating ferrule for plastic and vitreous china cisterns</i>	8029954073658
1514P	Galleggiante attacco basso NANOTEK 3/8" codolo lungo in resina acetlica per cassette in plastica e porcellana <i>Bottom entry filling valve NANOTEK 3/8" long pom tang for plastic and vitreous china cisterns</i>	8029954073689
1514AP	Galleggiante attacco basso NANOTEK 1/2" codolo lungo in resina acetlica per cassette in plastica e porcellana <i>Bottom entry filling valve NANOTEK 1/2" long pom tang for plastic and vitreous china cisterns</i>	8029954073719



Info packing

 Dimensioni imballo singolo <i>Single box dimensions</i>	10x7x33
 Peso imballo singolo <i>Weight single box</i>	0,25
 N° scatole singole in cartone master <i>N° single box in a master box</i>	16
 Dimensioni cartone master <i>Master box dimensions</i>	41x29x34
 N° cartoni master su pallet <i>N° master box on a pallet</i>	24
 Dimensioni pallet <i>Pallet dimensions</i>	80x120x220

RAMBO

Attacco laterale - Side entry



PROFESSIONAL

Line

Caratteristiche tecniche - Technical features

Funzionamento: <i>Functioning:</i>	Meccanico Mechanical
Attacco idrico: <i>Water connection:</i>	Laterale Side
Intervallo di regolazione altezza acqua: <i>Water level adjustment range:</i>	70 mm
Rumorosità con pressione a 3 bar: <i>Noise level with a water pressure of 3 bar:</i>	1° class (<20 decibel) <small>Conforme allo standard CE UNI EN 14124 in accordo con le condizioni del test di UNI EN 3822-1 Comply with CE standard UNI EN 14124 according to test conditions of UNI EN 3822-1</small>
Portata acqua a 3 bar: <i>Water flow at 3 bar:</i>	0,11 l/sec
Pressione statica massima: <i>Max. static pressure:</i>	16 bar
Funzionamento con pressione dinamica: <i>Functioning with dynamic pressure:</i>	0 ÷ 10 bar
Conforme alla normativa CE: <i>Comply with CE standard:</i>	UNI EN 14124

DOWNLOAD





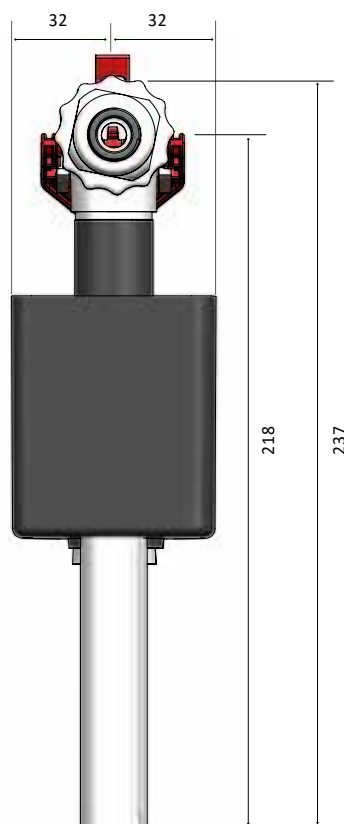
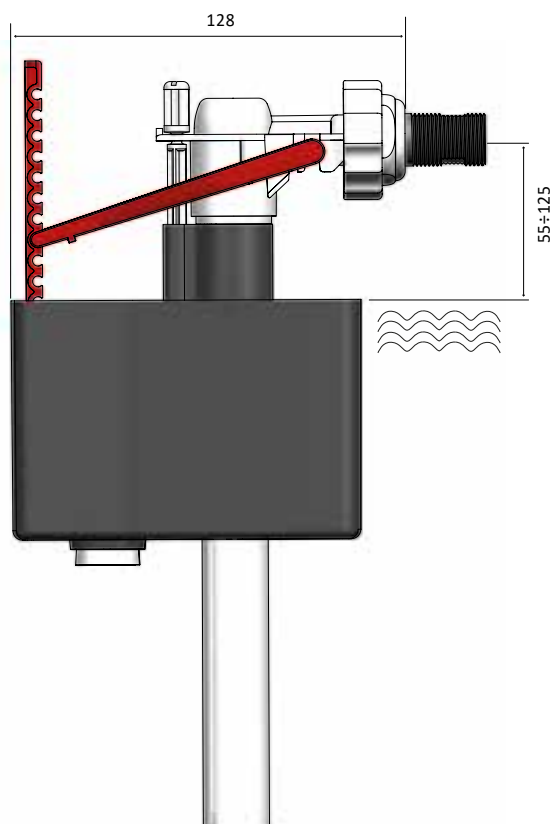

Vedi scheda tecnica
View technical sheet



Art. / Item	Descrizione / Models	EAN
1510	Galleggiante RAMBO 3/8" codolo ottone per cassette in plastica <i>Filling valve RAMBO 3/8" brass tang for plastic cisterns</i>	8029954003709
1510L	Galleggiante RAMBO 3/8" codolo ottone lungo per cassette in plastica e porcellana <i>Filling valve RAMBO 3/8" long brass tang for plastic and vitreous china cisterns</i>	8029954003716
1510AP	Galleggiante RAMBO 1/2" codolo lungo in resina acetica per cassette in plastica e porcellana <i>Filling valve RAMBO 1/2" long pom tang for plastic and vitreous china cisterns</i>	8029954003990
1510P	Galleggiante RAMBO 3/8" codolo lungo in resina acetica per cassette in plastica e porcellana <i>Filling valve RAMBO 3/8" long pom tang for plastic and vitreous china cisterns</i>	8029954003945
1510A	Galleggiante RAMBO 1/2" codolo ottone per cassette in plastica <i>Filling valve RAMBO 1/2" brass tang for plastic cisterns</i>	8029954003723



Info packing

 Dimensioni imballo singolo <i>Single box dimensions</i>	15,5x6x24
 Peso imballo singolo <i>Weight single box</i>	0,25
 N° scatole singole in cartone master <i>N° single box in a master box</i>	12
 Dimensioni cartone master <i>Master box dimensions</i>	40x32x26
 N° cartoni master su pallet <i>N° master box on a pallet</i>	54
 Dimensioni pallet <i>Pallet dimensions</i>	80x120x207

BLUE

Attacco laterale - Side entry



Caratteristiche tecniche - Technical features

Funzionamento: <i>Functioning:</i>	Meccanico Mechanical
Attacco idrico: <i>Water connection:</i>	Laterale Side
Intervallo di regolazione altezza acqua: <i>Water level adjustment range:</i>	67 mm
Rumorosità con pressione a 3 bar: <i>Noise level with a water pressure of 3 bar:</i>	10 decibel
Portata acqua a 3 bar: <i>Water flow at 3 bar:</i>	0,12 l/min
Pressione statica massima: <i>Max. static pressure:</i>	12 bar
Funzionamento con pressione dinamica: <i>Functioning with dynamic pressure:</i>	0,5 ÷ 10 bar



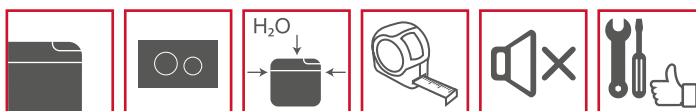

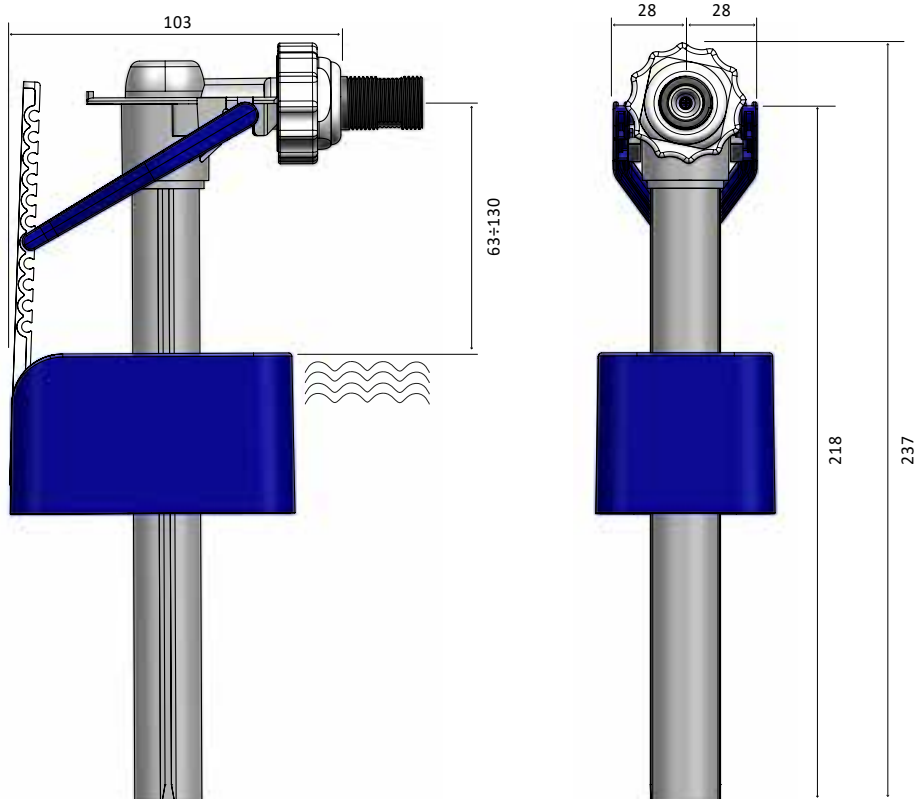

DOWNLOAD
Vedi scheda tecnica
View technical sheet



Art. / Item	Descrizione / Models	EAN
1520	Galleggiante BLUE 3/8" codolo ottone per cassette in plastica <i>Filling valve BLUE 3/8" brass tang for plastic cisterns</i>	8029954004270
1520L	Galleggiante BLUE 3/8" codolo ottone lungo per cassette in plastica e porcellana <i>Filling valve BLUE 3/8" long brass tang for plastic and vitreous china cisterns</i>	8029954004287
1520AP	Galleggiante BLUE 1/2" codolo lungo in resina acetale per cassette in plastica e porcellana <i>Filling valve BLUE 1/2" long pom tang for plastic and vitreous china cisterns</i>	8029954003938
1520P	Galleggiante BLUE 3/8" codolo lungo in resina acetale per cassette in plastica e porcellana <i>Filling valve BLUE 3/8" long pom tang for plastic and vitreous china cisterns</i>	8029954004300
1520A	Galleggiante BLUE 1/2" codolo ottone per cassette in plastica <i>Filling valve BLUE 1/2" brass tang for plastic cisterns</i>	8029954004294



Info packing

 Dimensioni imballo singolo <i>Single box dimensions</i>	13,5x5,5x25
 Peso imballo singolo <i>Weight single box</i>	0,18
 N° scatole singole in cartone master <i>N° single box in a master box</i>	14
 Dimensioni cartone master <i>Master box dimensions</i>	40x28,5x26,5
 N° cartoni master su pallet <i>N° master box on a pallet</i>	64
 Dimensioni pallet <i>Pallet dimensions</i>	80x120x227

1515

Attacco basso - Bottom entry

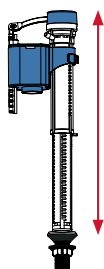
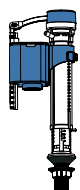

Caratteristiche tecniche - Technical features

Funzionamento: <i>Functioning:</i>	Contropressione Counterpressure
Attacco idrico: <i>Water connection:</i>	Basso Bottom
Intervallo di regolazione altezza acqua: <i>Water level adjustment range:</i>	162 mm
Rumorosità con pressione a 3 bar: <i>Noise level with a water pressure of 3 bar:</i>	1° class (<20 decibel) <small>Conforme allo standard CE UNI EN 14124 in accordo con le condizioni del test di UNI EN 3822-1 Comply with CE standard UNI EN 14124 according to test conditions of UNI EN 3822-1</small>
Portata acqua a 3 bar: <i>Water flow at 3 bar:</i>	0,15 l/sec
Pressione statica massima: <i>Max. static pressure:</i>	16 bar
Funzionamento con pressione dinamica: <i>Functioning with dynamic pressure:</i>	0,5 ÷ 10 bar

Telescopico
Telescopic



Art. / Item	Descrizione / Models	EAN
1515B	Galleggiante attacco basso 3/8" codolo in resina acetalica <i>Filling valve lower connection 3/8" pom tang</i>	8029954004478
1515C	Galleggiante attacco basso 1/2" codolo in resina acetalica <i>Filling valve lower connection 1/2" pom tang</i>	8029954004461
1515D	Galleggiante attacco basso 3/8" codolo in ottone <i>Filling valve lower connection 3/8" brass tang</i>	8029954004706
1515E	Galleggiante attacco basso 1/2" codolo in ottone <i>Filling valve lower connection 1/2" brass tang</i>	8029954004690

Info packing

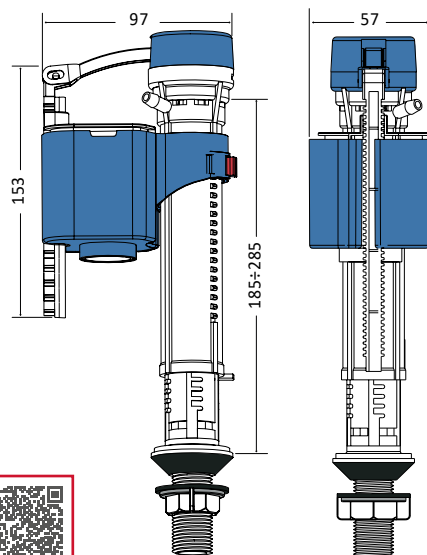

Dimensioni imballo singolo <i>Single box dimensions</i>	10x7x28,5
Peso imballo singolo <i>Weight single box</i>	0,28
N° scatole singole in cartone master <i>N° single box in a master box</i>	30
Dimensioni cartone master <i>Master box dimensions</i>	59x39x29
N° cartoni master su pallet <i>N° master box on a pallet</i>	28
Dimensioni pallet <i>Pallet dimensions</i>	80x120x225

DOWNLOAD

Vedi scheda tecnica
View technical sheet



1510NF

Attacco laterale - Side entry



Caratteristiche tecniche - Technical features

Funzionamento: <i>Functioning:</i>	Contropressione Counterpressure
Attacco idrico: <i>Water connection:</i>	Laterale Side
Intervallo di regolazione altezza acqua: <i>Water level adjustment range:</i>	100 mm
Rumorosità con pressione a 3 bar: <i>Noise level with a water pressure of 3 bar:</i>	1° class (<20 decibel) <small>Conforme allo standard CE UNI EN 14124 in accordo con le condizioni dei test di UNI EN 3822-1 Comply with CE standard UNI EN 14124 according to test conditions of UNI EN 3822-1</small>
Portata acqua a 3 bar: <i>Water flow at 3 bar:</i>	0,14 l/sec
Pressione statica massima: <i>Max. static pressure:</i>	16 bar
Funzionamento con pressione dinamica: <i>Functioning with dynamic pressure:</i>	0,5 ÷ 10 bar
Conforme alla normativa CE: <i>Comply with CE standard:</i>	UNI EN 14124



Art. / Item

Descrizione / Models

EAN





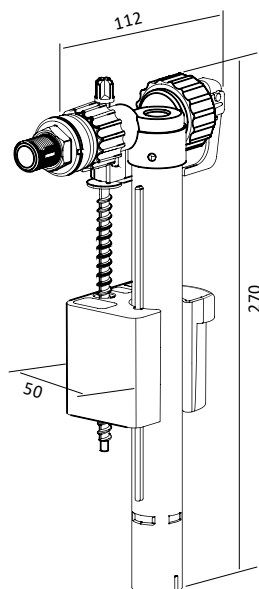

1510NF

Galleggiante 3/8" codolo ottone per cassette in plastica e porcellana
Floating valve 3/8" brass tang for plastic and vitreous china cisterns

8029954003730



Info packing

 Dimensioni imballo singolo <i>Single box dimensions</i>	16x5x27,5
 Peso imballo singolo <i>Weight single box</i>	0,26
 N° scatole singole in cartone master <i>N° single box in a master box</i>	25
 Dimensioni cartone master <i>Master box dimensions</i>	59x39x29
 N° cartoni master su pallet <i>N° master box on a pallet</i>	28
 Dimensioni pallet <i>Pallet dimensions</i>	80x120x225

DOWNLOAD

Vedi scheda tecnica
View technical sheet



1511L

Attacco laterale - Side connection



Caratteristiche tecniche

- Galleggiante in ottone
- Adatto per cassette in plastica o in porcellana
- Asta liscia e sfera scorrevole
- Regolabile in lunghezza

Technical features

- Brass filling valve
- Suitable for plastic and vitreous china cisterns
- Smooth bar and sliding floating ball
- Adjustable height

Art. / Item	Descrizione / Models	EAN
1511L	Galleggiante 3/8" codolo ottone per cassette in plastica e porcellana <i>3/8" brass tang for plastic and vitreous-china cisterns</i>	8029954003761

Ricambi per galleggianti Spare parts for filling valves



Art. / Item	Descrizione / Models	EAN
1542R3-10	Set 10 guarnizioni per galleggianti NANOTEK e 1515 <i>Set 10 gaskets for filling valves NANOTEK and 1515</i>	8029954073740









1542R2-10	Set 10 coppie guarnizioni per galleggianti RAMBO, BLUE e BLACK RAMBO <i>Set 10 couples of gaskets for filling valves RAMBO, BLUE e BLACK RAMBO</i>	8029954073757
-----------	---	---------------



1542S-10	Set 10 guarnizioni per galleggiante 1510NF <i>Set 10 gaskets for filling valve 1510NF</i>	8029954073764
----------	--	---------------



1542O-10	Set 10 guarnizioni per galleggiante 1511L <i>Set 10 gaskets for filling valve 1511L</i>	8029954073771
----------	--	---------------

Art. / Item	Descrizione / Models	EAN
 <p>1518</p>	<p>Sfera Ø 90 piatta con nottolino in ottone Flat ball Ø 90 with brass thread</p>	8029954003860
 <p>1518A</p>	<p>Sfera Ø 90 tonda con nottolino in ottone Round ball Ø 90 with brass thread</p>	8029954003877
 <p>1518B</p>	<p>Sfera Ø 120 tonda per asta passante Round ball Ø 120 for passing rod</p>	8029954003884
 <p>1518C</p>	<p>Sfera Ø 150 tonda per asta passante Round ball Ø 150 for passing rod</p>	8029954003891
 <p>1518D</p>	<p>Sfera Ø 180 tonda per asta passante Round ball Ø 180 for passing rod</p>	8029954003907
 <p>1518E</p>	<p>Sfera Ø 220 tonda per asta passante Round ball Ø 220 for passing rod</p>	8029954003914
 <p>1518H</p>	<p>Sfera Ø 120 tonda con nottolino in ottone 5/16 Round ball Ø 120 with 5/16 brass thread</p>	8029954003921

LEGENDA



Installazione a zaino o media posizione
Low or medium level installation

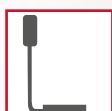

Installazione in posizione alta
High level installation

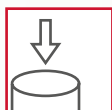

Diametro di entrata
Inlet diameter

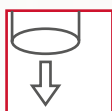

Diametro di uscita
Outlet diameter



Accessorio di morsetto
Equipped with bowl gasket



Versione colorata
Coloured version

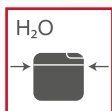

Attacco idrico laterale
Side water connection



Funzionamento silenzioso
Silent functioning



Montaggio semplice e veloce
Easy and fast mounting

COMPONENTI PER CASSETTE WC

COMPONENTS FOR WC CISTERNS

Studio delle esigenze, ricerca dei materiali, sviluppo delle soluzioni e massimizzazione della compatibilità: i punti chiave della nostra componentistica

Study of needs, research of materials, development of solutions and maximization of compatibility: the key points of our components



Tubi per cassetta a zaino
Pipes for low level cistern

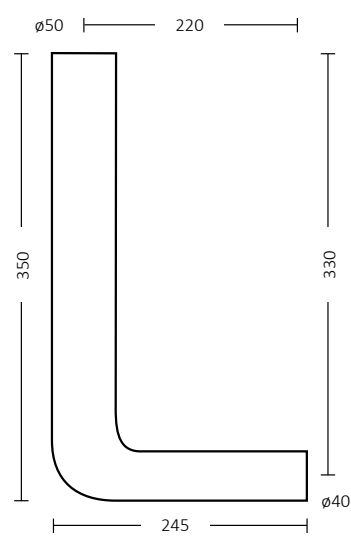
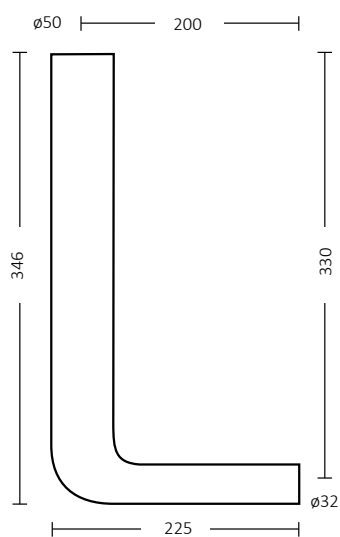
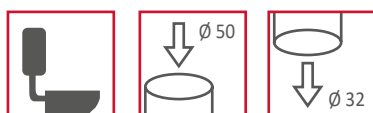

Art. / Item	Descrizione / Models	EAN
1501	Tubo ϕ 50x32, mm 346x225 Pipe ϕ 50x32, mm 346x225	8029954004034

Art. / Item	Descrizione / Models	EAN
1501A	Tubo ϕ 50x40, mm 350x245 Pipe ϕ 50x40, mm 350x245	8029954004041

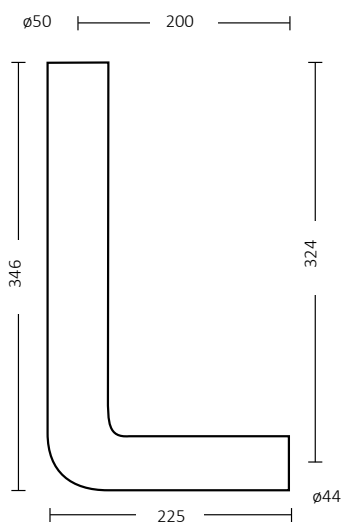
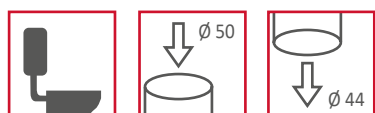

Art. / Item	Descrizione / Models	EAN
1501B	Tubo ø 50x44, mm 346x225 Pipe ø 50x44, mm 346x225	8029954004058

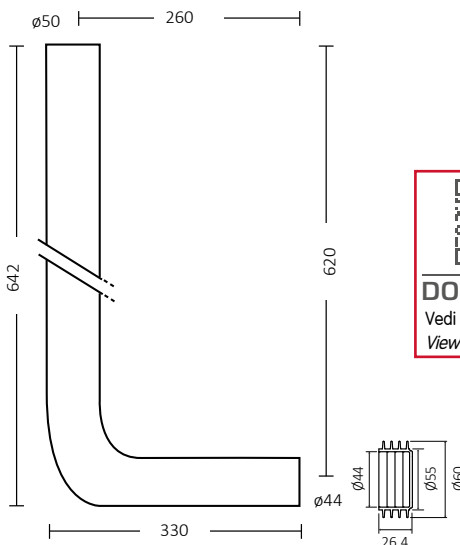

Art. / Item	Descrizione / Models	EAN
1501BLACC	Tubo ø 50x44, mm 642x330 completo di morsetto Pipe ø 50x44, mm 642x330 complete with bowl gasket	5947041005005

Tubi per cassetta a zaino Pipes for low level cistern

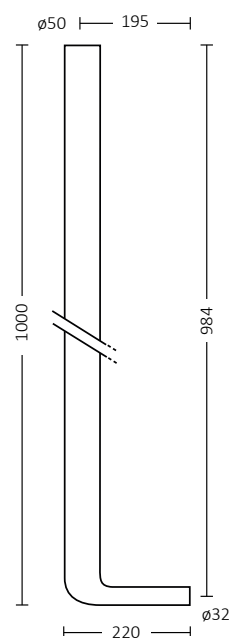
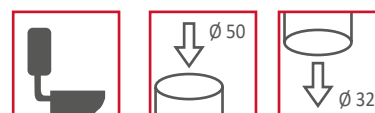
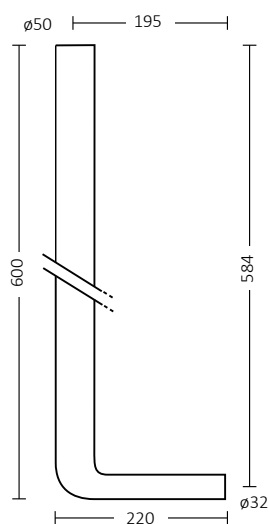
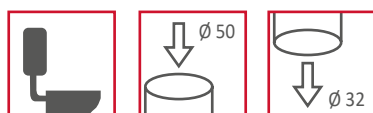

Art. / Item	Descrizione / Models		EAN
1502	Tubo $\varnothing 50 \times 32$, mm 600x220 Pipe $\varnothing 50 \times 32$, mm 600x220	50	8029954004065

Art. / Item	Descrizione / Models		EAN
1503	Tubo $\varnothing 50 \times 32$, mm 1000x220 Pipe $\varnothing 50 \times 32$, mm 1000x220	18	8029954004072

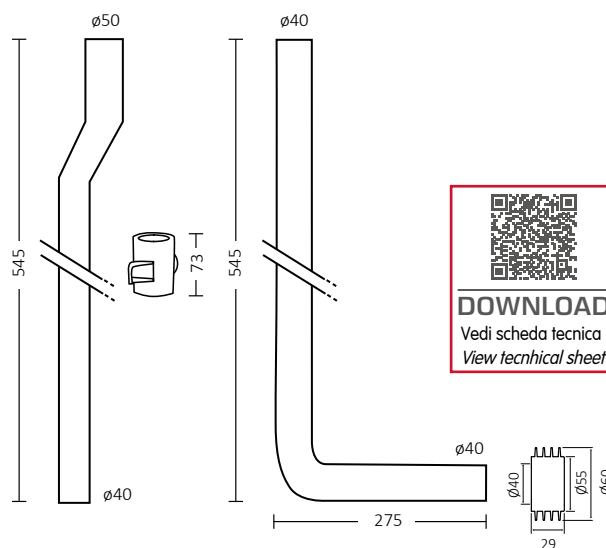
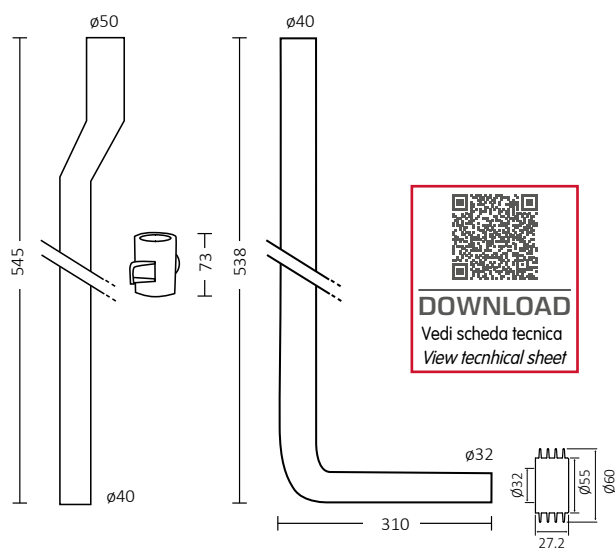

Art. / Item	Descrizione / Models		EAN
1503A	Tubo \varnothing 50x32 in due pezzi, mm 1084x310 Two pieces pipe \varnothing 50x32, mm 1084x310	20	8029954004089

Completo di raccordi, fissaggi, guarnizione conica \varnothing 50 e morsetto per vaso wc
Complete with connectors, fixings, conic gasket \varnothing 50 and bowl gasket

Art. / Item	Descrizione / Models		EAN
1503B	Tubo \varnothing 50x40 in due pezzi, mm 1091x275 Two pieces pipe \varnothing 50x40, mm 1091x275	20	8029954004096

Completo di raccordi, fissaggi, guarnizione conica \varnothing 50 e morsetto per vaso wc
Complete with connectors, fixings, conic gasket \varnothing 50 and bowl gasket

Tubi per cassetta a zaino Pipes for low level cistern

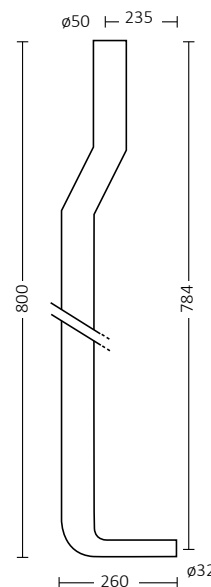
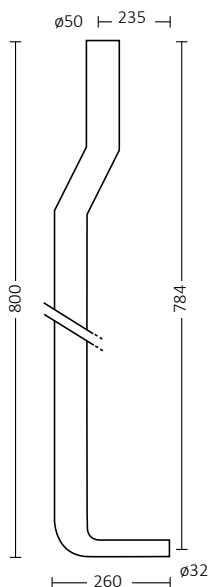
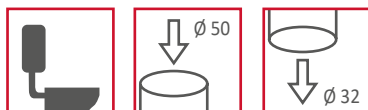

Art. / Item	Descrizione / Models		EAN
1508	Tubo \varnothing 50x32, mm 800x260 Pipe \varnothing 50x32, mm 800x260	20	8029954004140

Art. / Item	Descrizione / Models		EAN
1508CH	Tubo \varnothing 50x32, mm 800x260 Pipe \varnothing 50x32, mm 800x260	20	8029954004157

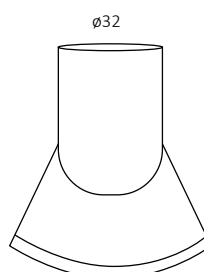
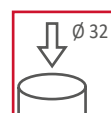
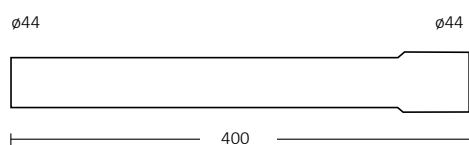
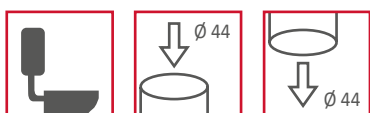

Art. / Item	Descrizione / Models	EAN
1507A	Prolunga tubo Ø 44, mm 400 Extension-pipe Ø 44, mm 400	8029954004171

Art. / Item	Descrizione / Models	EAN
1519	Spandiacqua per turca Ø 32 Water-spreader for turkish wc Ø 32	8029954001682

Tubi per cassetta alta Pipes for high level cistern



Esterno vaso
External bowl

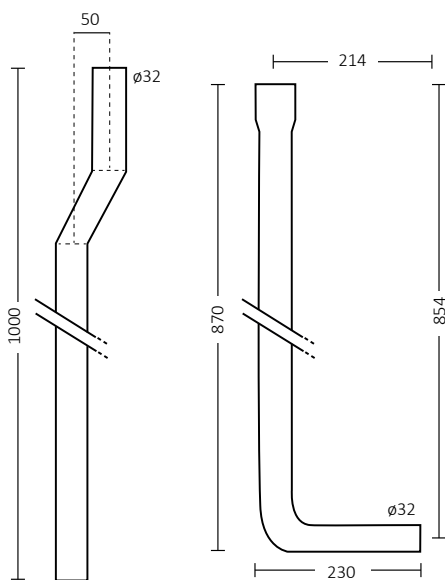
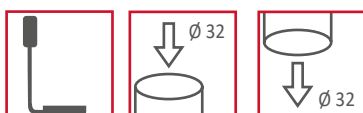

Esterno turca
External turkish
toilet

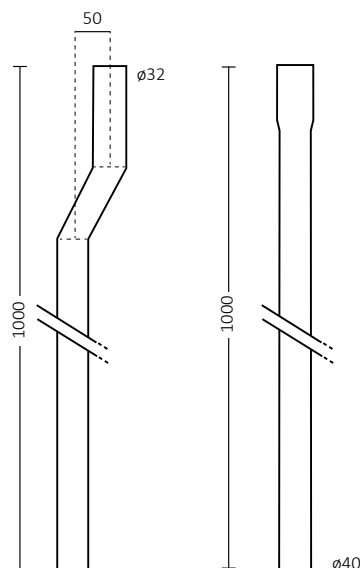
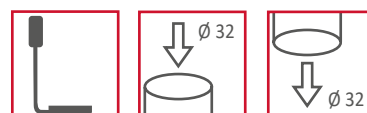

Art. / Item	Descrizione / Models		EAN
1500A	Tubo \varnothing 32, mm 1815x230 in fasci da 50 pezzi Pipe \varnothing 32, mm 1815x230 in strips of 50 pieces	50	8029954005284
1500AC	Tubo \varnothing 32, mm 1815x230 insacchettati singolarmente Pipe \varnothing 32, mm 1815x230, bagged individually	15	8029954004010

Art. / Item	Descrizione / Models		EAN
1500B	Tubo \varnothing 32, mm 1950 in fasci da 50 pezzi Pipe \varnothing 32, mm 1950, in strips of 50 pieces	50	8029954005291
1500BC	Tubo \varnothing 32, mm 1950 insacchettati singolarmente Pipe \varnothing 32, mm 1950, bagged individually	20	8029954004027



Da incasso
(interno muro)
*Built-in
(inside wall)*

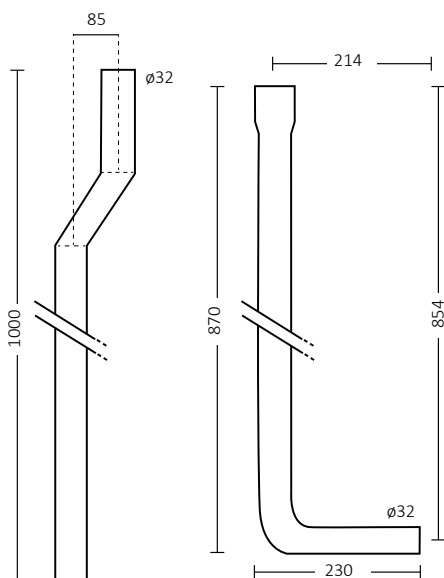
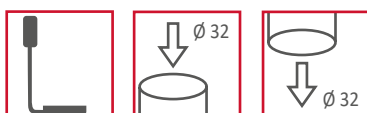

Per passo rapido
e flussometro
*For direct
water outlet*

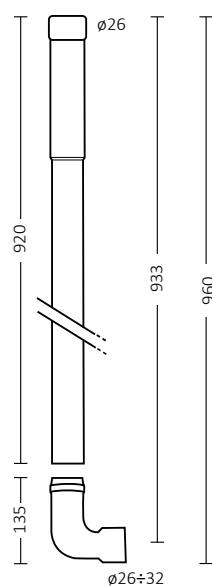

Art. / Item	Descrizione / Models		EAN
1500C	Tubo \varnothing 32, mm 1815x230, in fasci da 50 pezzi <i>Pipe \varnothing 32, mm 1815x230, in strips of 50 pieces</i>	50	8029954005307
1500CC	Tubo \varnothing 32, mm 1815x230, insacchettati singolarmente <i>Pipe \varnothing 32, mm 1815x230 bagged individually</i>	20	8029954004164

Art. / Item	Descrizione / Models		EAN
1504	Tubo \varnothing 26x26-32 per passo rapido e flussometro <i>Pipe \varnothing 32x26-32 for direct water-outlet</i>	25	8029954004102

Tubi per cassetta alta da incasso
Pipes for high level built-in cistern



Adattabili,
tagliando l'estremità
non utilizzata
*Adjustables,
by cutting the
end not used*

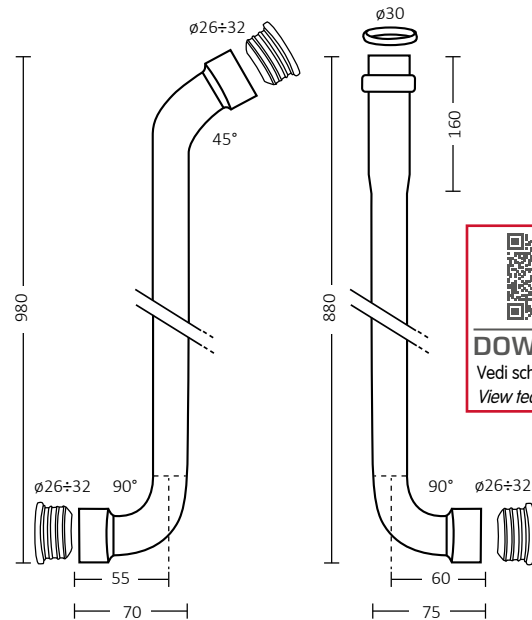
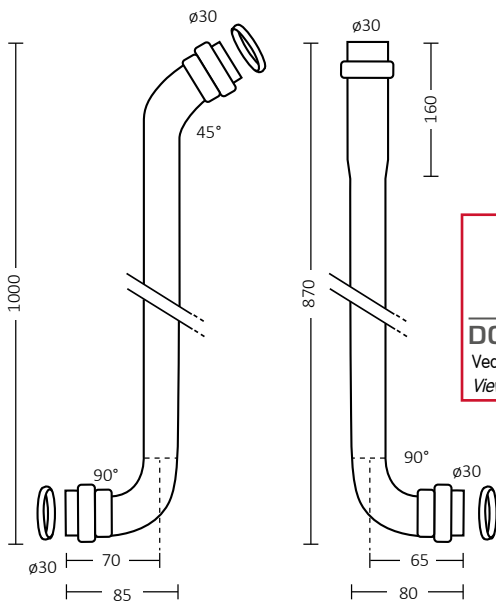
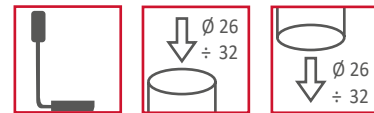
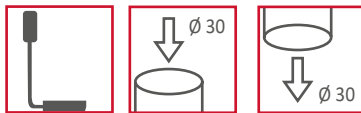

Art. / Item Descrizione / Models

EAN

1505	Tubo Ø 30, mm 1700, curve 45° e 90° con o.r. Pipe Ø 32x32, mm 1700, bends 45° / 90° with o.r.	8029954003150
------	--	---------------

Art. / Item Descrizione / Models

EAN

1505M	Tubo Ø 26÷32, mm 1700, curve 45° e 90° con morsetti Pipe Ø 26÷32, mm 1700, bends 45°/90° w/bowl gaskets	8029954003167
-------	---	---------------

Tubo per cassetta tipo Arabia
Pipe for Arabic high level cistern

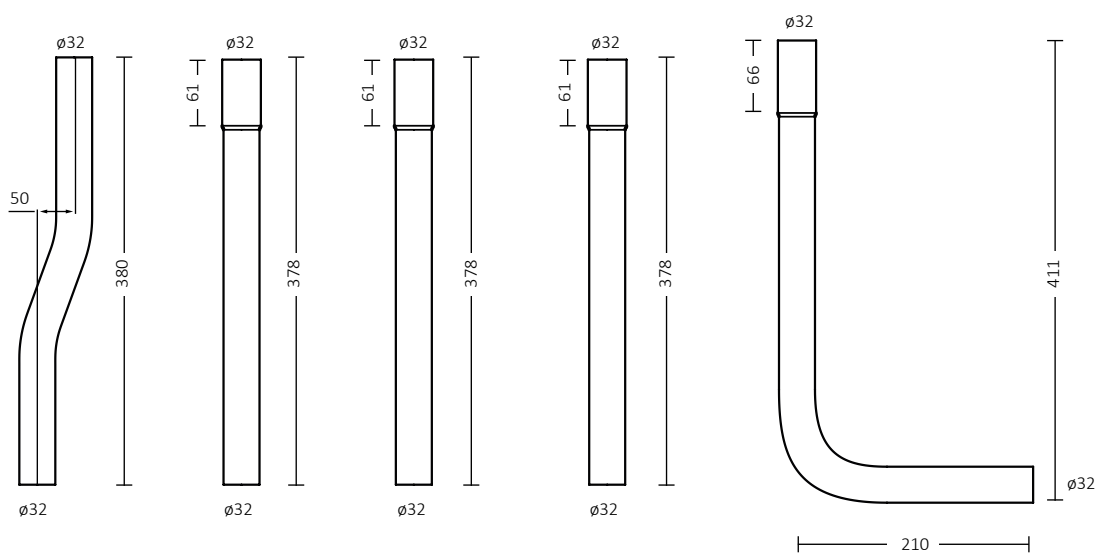
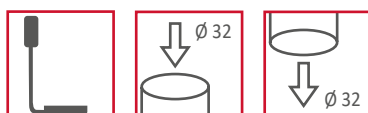

Art. / Item	Descrizione / Models	EAN
1500ARB	Tubo per cassetta alta tipo Arabia in 5 pezzi Pipe for high level cistern Arabia version 5 pieces	8029954008247

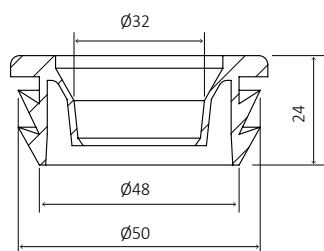
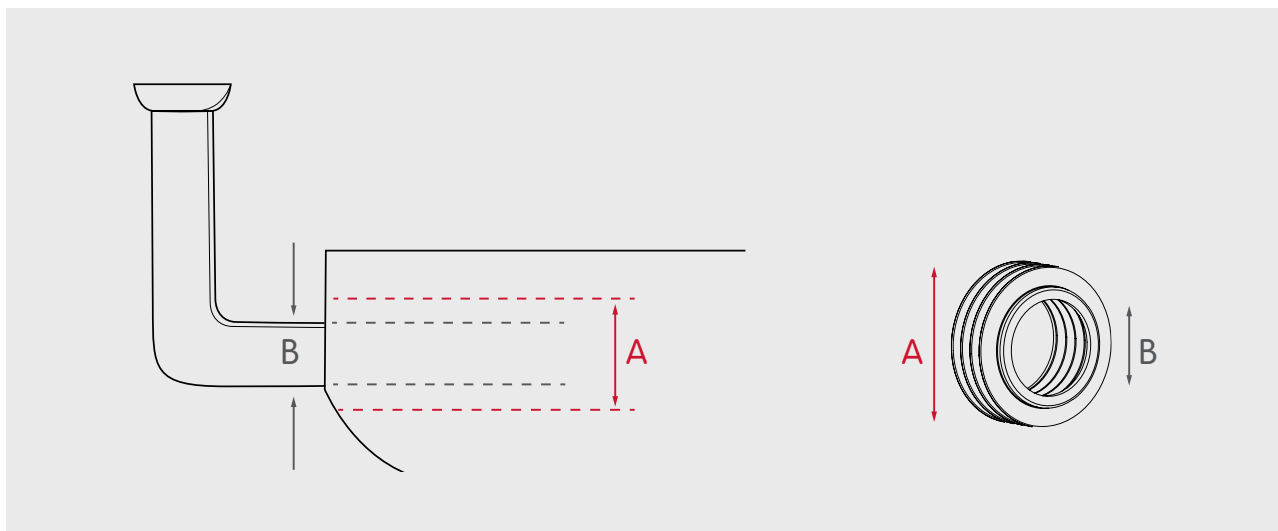

Art. / Item

Descrizione / Models

EAN

1523-10	Confezione 10 morsetti wc ϕ est. 48/50 x ϕ int. 32 Pack of 10 bowl gaskets ϕ est. 48/50 x ϕ int. 32		8029954007844
---------	--	--	---------------

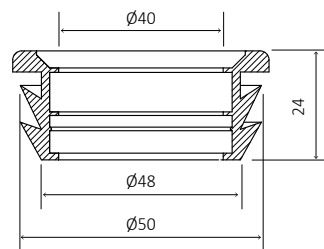

Art. / Item

Descrizione / Models

EAN

1523A-10	Confezione 10 morsetti wc ϕ est. 48/50 x ϕ int. 40 Pack of 10 bowl gaskets ϕ est. 48/50 x ϕ int. 40		8029954007851
----------	--	--	---------------

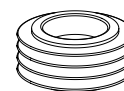
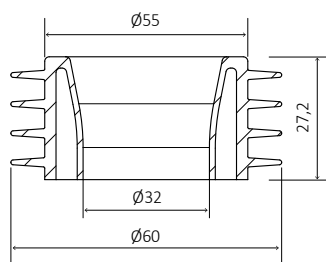

Art. / Item

Descrizione / Models

EAN

1524-10

Confezione 10 morsetti wc ϕ est. 55/60 x ϕ int. 32
Pack of 10 bowl gaskets ϕ est. 55/60 x ϕ int. 32

8029954007868

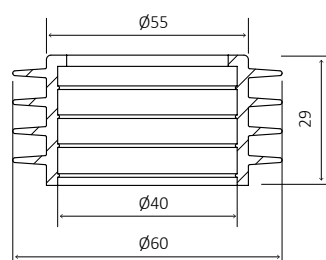

Art. / Item

Descrizione / Models

EAN

1524A-10

Confezione 10 morsetti wc ϕ est. 55/60 x ϕ int. 40
Pack of 10 bowl gaskets ϕ est. 55/60 x ϕ int. 40

8029954007875

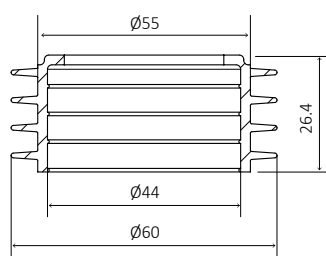

Art. / Item

Descrizione / Models

EAN

1524B-10

Confezione 10 morsetti wc ϕ est. 55/60 x ϕ int. 44
Pack of 10 bowl gaskets ϕ est. 55/60 x ϕ int. 44

8029954007882

Guarnizioni - Gaskets

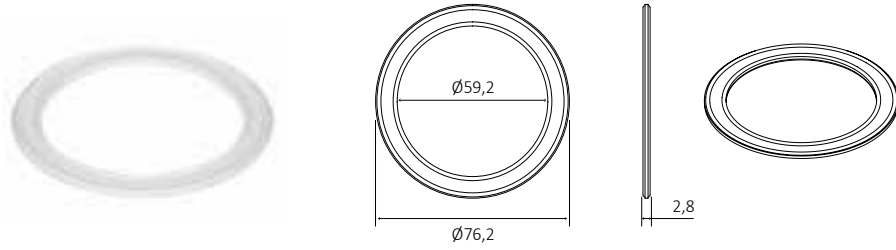

Art. / Item

Descrizione / Models

EAN

1535-10

Set 10 guarnizioni piane base meccanismo
Set 10 outlet valve flat gasket

8029954007592

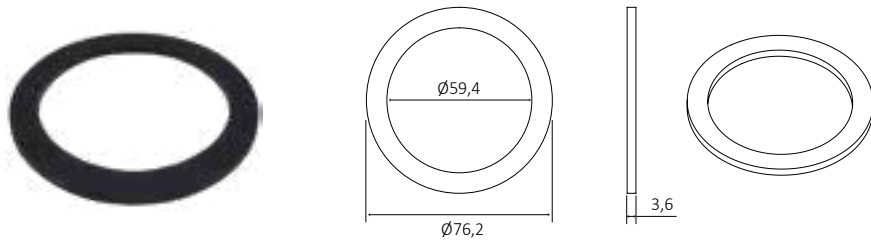

Art. / Item

Descrizione / Models

EAN

1535/02-10

Set 10 guarnizioni piane base meccanismo per Plus 2
Set 10 outlet valve flat gasket for wc cistern Plus 2

8029954007912

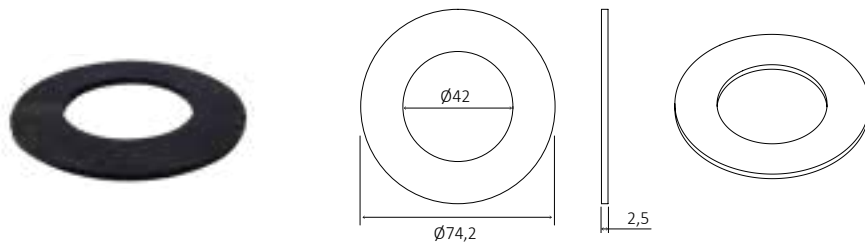

Art. / Item

Descrizione / Models

EAN

1536-10

Set 10 guarnizioni piane base meccanismo per cassetta alte Alfa e Cabrio
Set 10 outlet valve flat gasket for high level wc cisterns Alfa and Cabrio

8029954007585

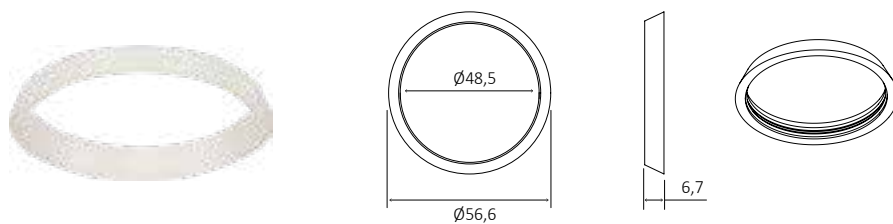

Art. / Item

Descrizione / Models

EAN

1538-10

Set 10 guarnizioni coniche per tubo Ø 50
Set 10 conical pipe gaskets Ø 50

8029954007578

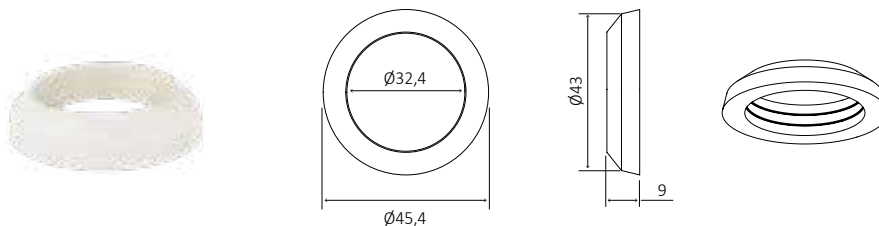

Art. / Item

Descrizione / Models

EAN

1539-10

Set 10 guarnizioni coniche per tubo \varnothing 32 per cassette alte (ante 2012)
Set 10 conical pipe gaskets \varnothing 32 for high level wc cistern (up to 2012)

8029954008360

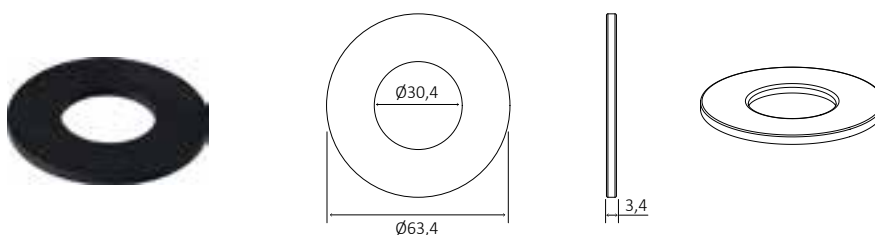

Art. / Item

Descrizione / Models

EAN

1540-10

Set 10 guarnizioni di tenuta meccanismo
Set 10 outlet valve gaskets

8029954007523

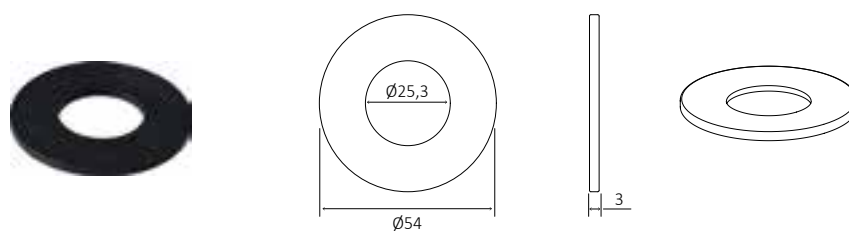

Art. / Item

Descrizione / Models

EAN

1540V-10

Set 10 guarnizioni di tenuta meccanismo (ante 1989)
Set 10 outlet valve gaskets (up to 1989)

8029954008377

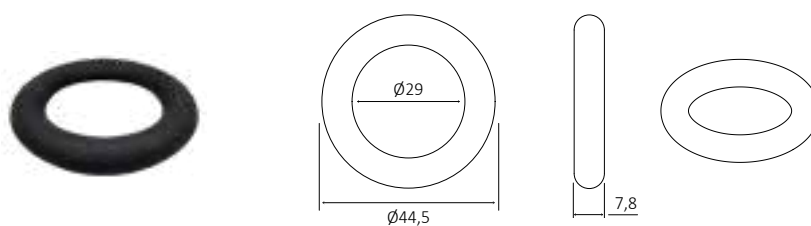

Art. / Item

Descrizione / Models

EAN

1543-10

Set 10 guarnizioni OR per tubi per cassetta alta da incasso art. 1505; 1505M; 1505A; 1505B
Set 10 O-ring gaskets for pipes for high level built-in cistern art. 1505; 1505M; 1505A; 1505B

8029954008384

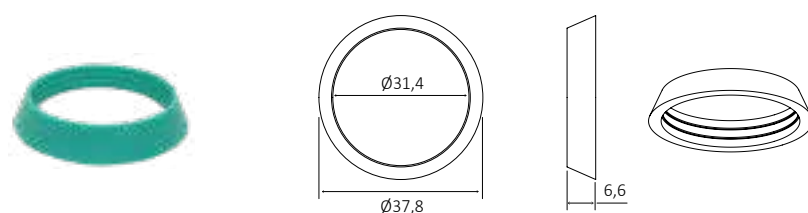

Art. / Item

Descrizione / Models

EAN

G4-10

Set 10 guarnizioni coniche per tubo \varnothing 32 per cassette alte Alfa e Cabrio
Set 10 conical gaskets for high level wc cisterns Alfa and Cabrio

8029954008292

Meccanismi per cassette alte in porcellana Flush valves for high level vitreous-china cisterns



Caratteristiche tecniche

- Meccanismo con pull a perlina
- Adatto a cassette alte in ceramica
- Troppopieno regolabile in altezza
- Galleggiante 3/8" attacco laterale
- Vitone in ottone cromato

Technical features

- Flush mechanism with chain pull
- Suitable for high level vitreous-china wc cisterns
- Adjustable overflow
- 3/8" floating valve, side or lower entry
- Chromate brass mechanism

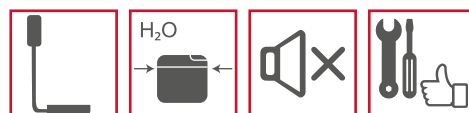

Art. / Item	Descrizione / Models	EAN
1406	Meccanismo a catenella con galleggiante a entrata laterale 3/8" per cassette alte in porcellana Flush valve with chain pull complete with 3/8" side entry floating valve for high-level vitreous-china cisterns	8029954005055

Equipaggiamento - Equipment



Galleggiante 3/8"
Blue, codolo plastica
Filling valve Blue,
with 3/8", pom tang

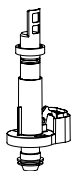

Meccanismo di
scarico
Flushing valve



Base in ottone
cromato
Chromate
brass base

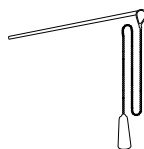

Asta cromata e
pull a perlina
Chromate rod
and chain pull

1406



Info packing

Dimensioni imballo singolo Single box dimensions	42x23x9
Peso imballo singolo Weight single box	0,627
N° pz. in cartone master N° pcs. box in a master box	30
Dimensioni cartone master Master box dimensions	60x40x42

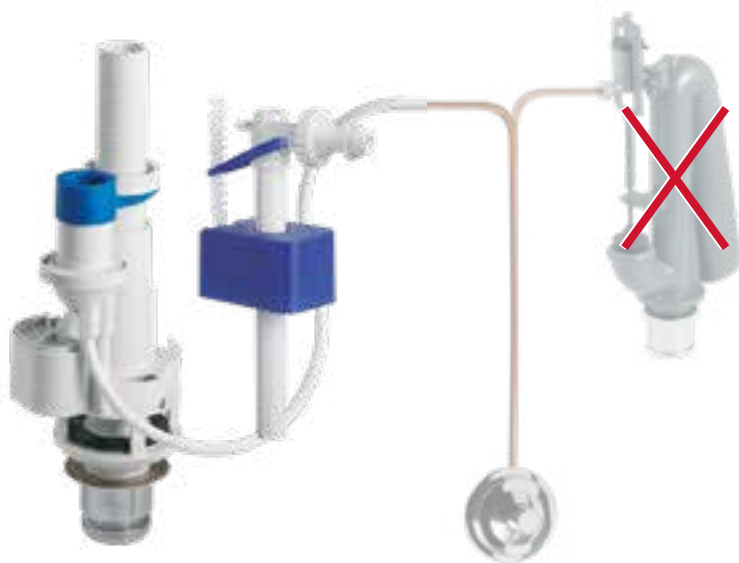

Caratteristiche tecniche

- Meccanismo a scarico singolo
- Adatto alla sostituzione di batterie pneumatiche pre-esistenti
- Adatto a cassette alte in ceramica
- Troppopieno regolabile in altezza
- Galleggiante 3/8" attacco laterale
- Vitone in ottone cromato
- Completo di tubetto 70 cm per connessione a vecchio tubo in rame

Technical features

- Single flush valve
- Suitable for substitution of old pneumatic flush valves
- Suitable for high level vitreous-china wc cisterns
- Adjustable overflow
- 3/8" floating valve, side or lower entry
- Chromate brass mechanism
- Complete with pipe 70 cm for connection to old copper pipe

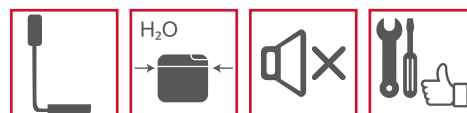

Pulsanti compatibili
Compatible push-buttons
pag./page
108 - 109



PE



PI



PEC



PIC



PPE



PPI

Art. / Item

Descrizione / Models

EAN

Art. / Item	Descrizione / Models	EAN
1407	Meccanismo pneumatico con galleggiante a entrata laterale 3/8" per cassette alte in porcellana <i>Pneumatic flush valve with 3/8" side entry floating valve for high-level vitreous-china cisterns</i>	8029954005109
1407SG	Meccanismo pneumatico per cassette alte in porcellana senza galleggiante <i>Pneumatic flush valve for high-level vitreous-china cisterns without floating valve</i>	8029954005116

Equipaggiamento - Equipment



Galleggiante 3/8"
Blue, codolo plastica
Filling valve Blue, with 3/8", pom tang

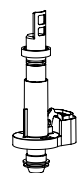

Meccanismo di scarico
Flushing valve



Base in ottone cromato
Chromate brass base

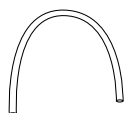

Tubetto pneu 70 cm di collegamento
Pneumatic pipe 70 cm for connection

1407



1407SG



Info packing

cm	Dimensioni imballo singolo <i>Single box dimensions</i>	42x23x9	
	Kg	Peso imballo singolo <i>Weight single box</i>	1407
1407SG			0,465
N° pz. in cartone master <i>N° pcs. box in a master box</i>	N° pz. in cartone master <i>N° pcs. box in a master box</i>	1407	28
		1407SG	45
cm	Dimensioni cartone master <i>Master box dimensions</i>	60x40x42	

Kit per conversione in cassetta pneumatica

Conversion kit to pneumatic cistern

Puoi trasformare facilmente la tua cassetta CR in una cassetta pneumatica, ordinando l'apposita batteria pneumatica con un pulsante a scelta.

You can easily convert your CR cistern into a pneumatic cistern by purchasing the dedicated flush valve with the remote control of your choice.

Esempio / example : Concept con pedale pneumatico esterno / Concept with external foot-push button = Concept 1000C1 + kit 1408G + PPE



Art. / Item	Descrizione / Models	EAN
1408G	Meccanismo pneumatico mod. A <i>Pneumatic flushing valve type A</i>	8029954004416



Completo di morsetto di riduzione ø32 per tubi cassette alte
Equipped with reduction ø32 for high level pipes
Adatto a cassette / Suitable for cisterns: Concept; Genius; Sfera



Art. / Item	Descrizione / Models	EAN
1408X	Meccanismo pneumatico mod. B <i>Pneumatic flushing valve type B</i>	8029954004423



Completo di morsetto di riduzione ø32 per tubi cassette alte
Equipped with reduction ø32 for high level pipes
Adatto a cassette / Suitable for cisterns: Plus; Beta; Angolo; Smart; Export; Alfa; Delta; Polo

Pulsanti pneumatici - Pneumatic remote controls



Art. / Item	Descrizione / Models	EAN
PE	Pulsante esterno completo di tubetto, canalina rigida e fissaggi <i>External push-button complete with pipe, rigid tube and fixings</i>	8029954004324



Art. / Item	Descrizione / Models	EAN
PI	Pulsante incasso completo di tubetto e guaina flessibile <i>Built-in push-button complete with pipe and flexible sheath</i>	8029954004331



Art. / Item	Descrizione / Models	EAN
PEC	Pulsante esterno cromato completo di tubetto, canalina rigida e fissaggi <i>Chromed external push-button complete with pipe, rigid tube and fixings</i>	8029954004430



Art. / Item	Descrizione / Models	EAN
PIC	Pulsante incasso cromato completo di tubetto e guaina flessibile <i>Chromed external push-button complete with pipe and flexible sheath</i>	8029954004447



Art. / Item	Descrizione / Models	EAN
1530B	Pulsante cromato per applicazioni speciali su pareti attrezzate <i>Chromed push-button for special applications on furnitures</i>	8029954005413



Art. / Item	Descrizione / Models	EAN
PPE	Pulsante esterno a pedale completo di tubetto e guaina flessibile <i>External foot push-button complete with pipe and flexible sheath</i>	8029954004348



Art. / Item	Descrizione / Models	EAN
PPI	Pulsante incasso a pedale completo di tubetto e guaina flessibile <i>Built-in foot push-button complete with pipe and flexible sheath</i>	8029954004355

Rubinetto a squadra per cassette wc - *Chromate brass tap*



Art. / Item	Descrizione / Models	EAN
1516C	Rubinetto a squadra 1/2" ottone cromato per galleggianti 3/8" <i>1/2" chromate brass tap for 3/8" filling valves</i>	8029954005246

Equipaggiato con tubetto 180 mm malleabile
Equipped with 180 mm malleable tube



Art. / Item	Descrizione / Models	EAN
1550	Riduzione in acciaio M 1/2" x F 3/8" <i>Steel reduction Male 1/2" x Female 3/8"</i>	8029954003853

Tubi flessibili - *Flexible hose*



Art. / Item	Descrizione / Models	EAN
SM0158	Flessibile 3/8" x 3/8", lunghezza 25 cm <i>Flexible hose 3/8" x 3/8", length 25 cm</i>	8029954003785

La cassetta wc puo' essere accessoriata con PORTA-ROTOLO CROMATO, utilizzabile anche per asciugamani, installabile lateralmente nel fusto della cassetta
Sporgenza 14 cm

The wc cistern can be equipped with CHROMED TOILET PAPER ROLL-HOLDER, usable also for personal towel, mountable on the side of the cisterns' body
Lenght 14 cm



Art. / Item	Descrizione / Models	EAN
1185N/01	Porta-rotolo cromato per cassette wc Toilet paper roll-holder for wc cisterns	8029954005260

IDRO-KIT per cassette wc esterne - for external wc cistens



Flessibile
Flexible hose

Rubinetto per regolazione della pressione dell'acqua nella doccia
Tap as pressure regulator of water in the shut-off shower

Doccetta shut-off
Shut-off shower



Art. / Item	Descrizione / Models	EAN
IDROKIT	Kit per conversione cassetta wc in idrocassetta Conversion kit to wc hydrocistern	8029954005277

LEGENDA



Installazione in posizione monoblocco
Monoblock installation

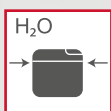

Attacco idrico laterale
Side water connection

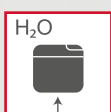

Attacco idrico inferiore
Bottom water connection



Scarico singolo
Single flush



Doppio scarico
Double flush



Funzionamento silenzioso
Silent functioning



Montaggio semplice e veloce
Easy and fast mounting

MECCANISMI PER MONOBLOCCO VALVES FOR TWO-PIECE TOILETS

**L'esperienza tecnica nelle materie plastiche si incontra con
le esigenze della porcellana tradizionale**

*The technical experience in plastics meets the needs
of traditional porcelain*



Meccanismi a scarico singolo Single flush valve



Caratteristiche tecniche

- Meccanismo a scarico singolo
- Adatto a cassette monoblocco in porcellana
- Troppopieno regolabile in altezza
- Galleggiante 3/8" attacco laterale o attacco basso, regolabile
- Pulsante compatibile con fori ø40 mm e ø20 mm

Technical features

- Single flush valve
- Suitable for monoblock vitreous-china wc cisterns
- Adjustable overflow
- 3/8" floating valve, side or lower entry, adjustable
- Button suitable for holes ø40 mm and ø20 mm



1530A

Pulsante a scarico singolo
Single flush push-button



Art. / Item	Descrizione / Models		EAN
1402	Meccanismo a spingere con galleggiante a entrata laterale 3/8" Mechanical push-button flush valve with 3/8" floating valve for side entry		8029954005000
1403	Meccanismo a spingere con galleggiante a entrata dal basso 3/8" Mechanical push-button flush valve with 3/8" floating valve for lower entry		8029954005031

Equipaggiamento - Equipment



Galleggiante 3/8"
attacco laterale
Filling valve Blue,
side entry

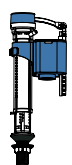

Galleggiante 3/8"
attacco basso
3/8" filling valve
bottom entry

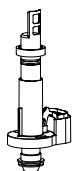

Meccanismo di
scarico
Flushing valve

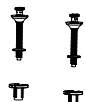

Kit di fissaggio
Fixing kit



Guarnizioni
Gaskets



Tappino
3/8" e 1/2"
Plug 3/8"
and 1/2"

1402 ✓ ✓ ✓ ✓ ✓

1403 ✓ ✓ ✓ ✓

Info packing

Dimensioni imballo singolo Single box dimensions	42x23x9	
Peso imballo singolo Weight single box	1402	0,477
	1403	0,591
N° pz. in cartone master N° pcs. box in a master box	1402	30
	1403	30
Dimensioni cartone master Master box dimensions	60x40x42	



Caratteristiche tecniche

- Meccanismo pneumatico a scarico singolo
- Adatto a cassette monoblocco in porcellana
- Troppopieno regolabile in altezza
- Galleggiante 3/8" attacco laterale o attacco basso, regolabile
- Pulsante compatibile con fori ø40 mm e ø20 mm

Technical features



- Single flush pneumatic valve
- Suitable for monoblock vitreous-china wc cisterns
- Adjustable overflow
- 3/8" floating valve, side or lower entry, adjustable
- Button suitable for holes ø40 mm and ø20 mm



1530B

Pulsante pneumatico a scarico singolo
Single flush pneumatic push-button



Art. / Item	Descrizione / Models		EAN
1402A	Meccanismo pneumatico con galleggiante a entrata laterale 3/8" Pneumatic push-button flush valve with 3/8" floating valve for side entry		8029954004959
1403A	Meccanismo pneumatico con galleggiante a entrata dal basso 3/8" Pneumatic push-button flush valve with 3/8" floating valve for lower entry		8029954004980

Equipaggiamento - Equipment



Galleggiante 3/8" attacco laterale
Filling valve Blue, side entry

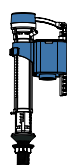

Galleggiante 3/8" attacco basso
3/8" filling valve bottom entry

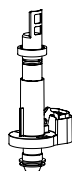

Meccanismo di scarico
Flushing valve

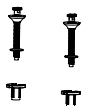

Kit di fissaggio
Fixing kit







Guarnizioni
Gaskets



Tappino 3/8" e 1/2"
Plug 3/8" and 1/2"

1402A	✓	✓	✓	✓	✓
1403A		✓	✓	✓	✓

Info packing

 Dimensioni imballo singolo Single box dimensions	42x23x9	
 Peso imballo singolo Weight single box	1402A	0,54
	1403A	0,654
 N° pz. in cartone master N° pcs. box in a master box	1402A	27
	1403A	28
 Dimensioni cartone master Master box dimensions	60x40x42	

Meccanismi a doppio scarico Double flush valve



Caratteristiche tecniche

- Meccanismo a doppio scarico
- Adatto a cassette monoblocco in porcellana
- Troppopieno regolabile in altezza
- Galleggiante 3/8" attacco laterale o attacco basso, regolabile
- Pulsante compatibile con fori ø40 mm e ø20 mm
- Scarico regolabile

Technical features

- Double flush valve
- Suitable for monoblock vitreous-china wc cisterns
- Adjustable overflow
- 3/8" floating valve, side or lower entry, adjustable
- Button suitable for holes ø40 mm and ø20 mm
- Adjustable flush



1530C

Pulsante a doppio scarico
Double flush push-button



Art. / Item	Descrizione / Models		EAN
1402B	Meccanismo a doppio scarico con galleggiante a entrata laterale 3/8" Double flush mechanical valve with 3/8" floating valve for side entry		8029954004928
1403B	Meccanismo a doppio scarico con galleggiante a entrata dal basso 3/8" Double flush mechanical valve with 3/8" floating valve for lower entry		8029954004935

Equipaggiamento - Equipment



Galleggiante 3/8"
attacco laterale
Filling valve Blue,
side entry

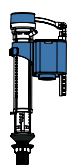

Galleggiante 3/8"
attacco basso
3/8" filling valve
bottom entry

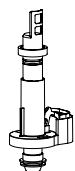

Meccanismo di
scarico
Flushing valve



Kit di fissaggio
Fixing kit



Guarnizioni
Gaskets



Tappino
3/8" e 1/2"
Plug 3/8"
and 1/2"

1402B ✓ ✓ ✓ ✓ ✓

1403B ✓ ✓ ✓ ✓

Info packing

Dimensioni imballo singolo Single box dimensions	42x23x9	
Peso imballo singolo Weight single box	1402B	0,54
	1403B	0,65
N° pz. in cartone master N° pcs. box in a master box	1402B	25
	1403B	26
Dimensioni cartone master Master box dimensions	60x40x42	



Caratteristiche tecniche

- Meccanismo a doppio scarico a cavo
- Adatto a cassette monoblocco in porcellana
- Troppopieno regolabile in altezza
- Galleggiante 3/8" attacco laterale o attacco basso, regolabile
- Pulsante compatibile con fori ø40 mm e ø20 mm
- Scarico regolabile

Technical features



- Double flush cable valve
- Suitable for monoblock vitreous-china wc cisterns
- Adjustable overflow
- 3/8" floating valve, side or lower entry, adjustable
- Button suitable for holes ø40 mm and ø20 mm
- Adjustable flush



1530D

Pulsante a doppio scarico
Double flush push-button



Art. / Item	Descrizione / Models		EAN
1402C	Meccanismo a cavo a doppio scarico con galleggiante a entrata laterale 3/8" Double flush cable valve with 3/8" floating valve for side entry		8029954004904
1403C	Meccanismo a cavo a doppio scarico con galleggiante a entrata dal basso 3/8" Double flush cable valve with 3/8" floating valve for lower entry		8029954004911

Equipaggiamento - Equipment

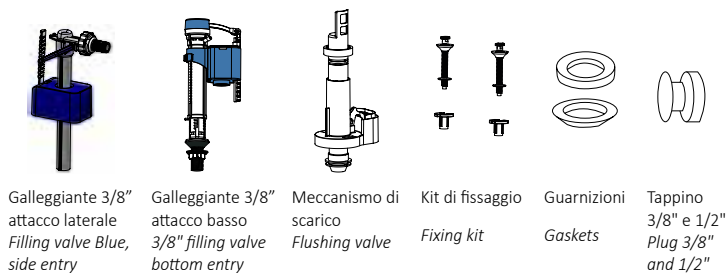

Galleggiante 3/8" attacco laterale
Filling valve Blue, side entry

Galleggiante 3/8" attacco basso
3/8" filling valve bottom entry

Meccanismo di scarico
Flushing valve

Kit di fissaggio
Fixing kit





Guarnizioni
Gaskets

Tappino 3/8" e 1/2"
Plug 3/8" and 1/2"

1402C ✓ ✓ ✓ ✓ ✓

1403C ✓ ✓ ✓ ✓

Info packing

 Dimensioni imballo singolo Single box dimensions	42x23x9	
 Peso imballo singolo Weight single box	1402C	0,602
	1403C	0,695
 N° pz. in cartone master N° pcs. box in a master box	1402C	22
	1403C	24
 Dimensioni cartone master Master box dimensions	60x40x42	

Meccanismi a tirare Pull flush valve



Caratteristiche tecniche

- Meccanismo a tirare
- Adatto a cassette monoblocco in porcellana
- Troppopieno regolabile in altezza
- Galleggiante 3/8" attacco laterale o attacco basso, regolabile
- Pulsante compatibile con fori ø40 mm e ø20 mm
- Scarico regolabile

Technical features

- Pull flush cable valve
- Suitable for monoblock vitreous-china wc cisterns
- Adjustable overflow
- 3/8" floating valve, side or lower entry, adjustable
- Button suitable for holes ø40 mm and ø20 mm
- Adjustable flush

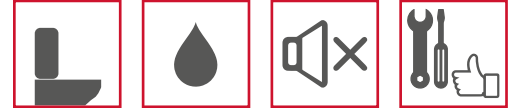

Art. / Item	Descrizione / Models		EAN
1402T	Meccanismo a tirare con galleggiante a entrata laterale 3/8" Pull flush cable valve with 3/8" floating valve for side entry		8029954005208
1403T	Meccanismo a tirare con galleggiante a entrata dal basso 3/8" Pull flush cable valve with 3/8" floating valve for lower entry		8029954005215

Equipaggiamento - Equipment



Galleggiante 3/8"
attacco laterale
Filling valve Blue,
side entry

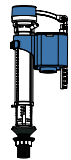

Galleggiante 3/8"
attacco basso
3/8" filling valve
bottom entry

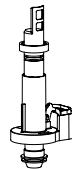

Meccanismo di
scarico
Flushing valve



Kit di fissaggio
Fixing kit



Guarnizioni
Gaskets















Tappino
3/8" e 1/2"
Plug 3/8"
and 1/2"

1402T	✓	✓	✓	✓	✓
1403T		✓	✓	✓	✓

Info packing

Dimensioni imballo singolo Single box dimensions	42x23x9	
Peso imballo singolo Weight single box	1402T	0,464
	1403T	0,578
N° pz. in cartone master N° pcs. box in a master box	1402T	30
	1403T	30
Dimensioni cartone master Master box dimensions	60x40x42	

Ricambi per meccanismi Spare parts for flush valves

Art. / Item	Descrizione / Models		EAN
 1530A	Pulsante per meccanismi a scarico singolo art. 1402, 1403 <i>Push-button for single flush valves art.1402, 1403</i>		8029954005468
 1530B	Pulsante per meccanismi pneumatici a scarico singolo art. 1402A,1403A <i>Push-button for single flush pneumatic valves art.1402A, 1403A</i>		8029954005413
 1530C	Pulsante per meccanismi a doppio scarico art. 1402B, 1403B <i>Push-button for double flush valves art.1402B, 1403B</i>		8029954005369
 1530D	Pulsante per meccanismi a doppio scarico a cavo art. 1402C, 1403C <i>Push-button for double flush cable valves art.1402C, 1403C</i>		8029954005376
 1526	Kit viti in metallo per fissaggio cassetta al vaso monoblocco <i>Bowl fixing kit for monoblock with metal screws</i>		8029954005383
 1526X	Kit viti inox per fissaggio cassetta al vaso monoblocco <i>Bowl fixing kit for monoblock with stainless steel screws</i>		8029954005352
 1526QF	Kit viti nylon "quick fix" per fissaggio cassetta al vaso monoblocco <i>Bowl fixing kit for monoblock with "quick fix" nylon screws</i>		8029954005253
 1527	Guarnizione in gomma sbs tra cassetta e vaso monoblocco <i>Sbs rubber gasket between tank and bowl</i>		8029954005390
 1527/02	Guarnizione in mousse epdm tra cassetta e vaso monoblocco <i>Mousse epdm gasket between tank and bowl</i>		8029954049684
 1537	Guarnizione conica per meccanismi per cassette in ceramica <i>Conical gasket for flush valves for vitreous-china wc cisterns</i>		8029954005420
 1540-10	Set 10 guarnizioni per valvole meccaniche e pneumatiche <i>Set 10 gaskets for mechanical and pneumatic flush valves</i>		8029954007523
 1540D	Guarnizione di tenuta per batterie a cavo <i>Outlet valve gasket for cable flush valves</i>		8029954003297

LEGENDA



Completo di valvola gravitazionale
Complete with gravitational valve



Adatto a doccia
Suitable for shower



Installazione a pavimento
Floor installation



Adatto a piatto doccia
Suitable for shower tray



Adatto a vasca
Suitable for bath



Adatto a lavabo
Suitable for sink



Adatto a bidet
Suitable for bidet



Adatto a lavello inox
Suitable for stainless steel washbasin



Adatto a lavello in ceramica
Suitable for fire-clay washbasin



Adatto a lavatrice
Suitable for washing-machine



Adatto a wc
Suitable for wc

SIFONAME SIPHONS

La gamma di sifoni CR si distingue per adattabilità, design e intelligenza pratica, garantendo ai tuoi ambienti uno scarico silenzioso, igienico e affidabile

The range of siphons CR stands out for adaptability, design and practical intelligence, ensuring to your environments a quiet, hygienic and reliable draining



LEGENDA



Prodotto in stock
Product in stock



Prodotto su richiesta
per grandi quantità
*Product on request
for big quantities*

CANALINA NILO

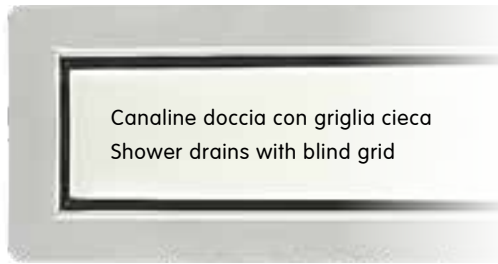

VALVOLA GRAVITAZIONALE - GRAVITATIONAL VALVE



L'innovativa valvola gravitazionale:

- funziona anche in caso di evaporazione dell'acqua
- ha una velocità di scarico superiore rispetto al sifone classico

The innovative gravitational valve:

- Works also in case of evaporation of water
- Has a higher flow rate than the classic siphon



Valvola gravitazionale anti-odori
Anti-smell gravitational valve

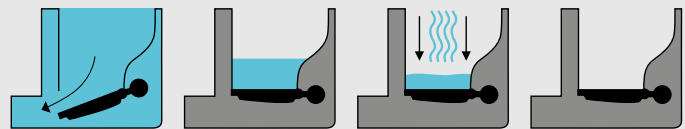

Sifone classico
Classic siphon

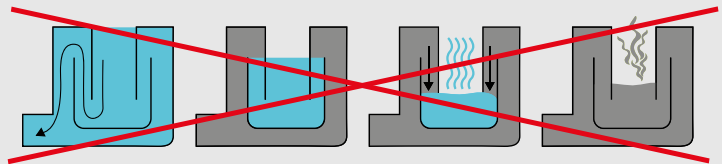

Profilo esterno a vista in acciaio INOX
Stainless steel external profile

Installazione a filo pavimento
Floor level installation

PROFESSIONAL

Line

Caratteristiche tecniche

Profilo esterno: A vista in acciaio INOX

Sifone di scarico: Valvola gravitazionale anti-odore ispezionabile

Piedini: Regolabili manualmente in altezza 18 mm

Portata di scarico: 60 l/min

Temperatura massima acqua: 95°C

Classe di carico: K3 300 kg EN 1253

Materiale per il montaggio: Equipaggiata con pannello isolante idrorepellente per la messa a terra e gancio per rimozione griglia

Technical features

External profile: Stainless steel external profile at sight

Siphon: Anti-smell gravitational valve, inspectionable

Feet: Adjustable feet 18 mm

Flow rate: 60 l/min

Water temperature max.: 95°C

Loading class: K3 300 kg EN 1253

Mounting material: Equipped with water-repellent adhesive tape and hook for grid removal

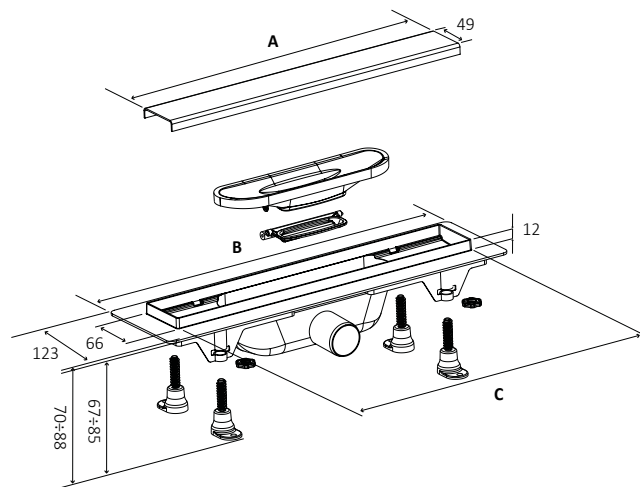

DOWNLOAD

Vedi scheda tecnica
View technical sheet

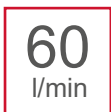
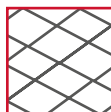

Art.	Tipo di griglia / Type of grid		Dimensione griglia Dimensione grid	Dimensione griglia		
	Cieca / Blind	Piastrellabile / Tileable		A	B	C
Art. R400X	R400X	R400K	398 mm	380	455	398
Art. R500X	R500X	R500K	501 mm	497	560	501
Art. R700X	R700X	R700K	660 mm	644	718	660
Art. R800X	R800X	R800K	762 mm	745	820	762
Art. R900X	R900X	R900K	862 mm	846	920	862

Art. / Item

Descrizione / Models



EAN

R400X	Canalina doccia NILO con griglia cieca in acciaio inox mm 398 Shower drain NILO with blind stainless steel grid mm 398	1	51x15x9	8029954011599
R500X	Canalina doccia NILO con griglia cieca in acciaio inox mm 501 Shower drain NILO with blind stainless steel grid mm 501	1	57x15x9	8029954011674
R700X	Canalina doccia NILO con griglia cieca in acciaio inox mm 660 Shower drain NILO with blind stainless steel grid mm 660	1	75x15x9	8029954011605
R800X	Canalina doccia NILO con griglia cieca in acciaio inox mm 762 Shower drain NILO with blind stainless steel grid mm 762	1	85x15x9	8029954011612
R900X	Canalina doccia NILO con griglia cieca in acciaio inox mm 862 Shower drain NILO with blind stainless steel grid mm 862	1	95x15x9	8029954011629
R400K	Canalina doccia NILO con griglia piastrellabile in acciaio inox mm 398 Shower drain NILO with tileable stainless steel grid mm 398	1	51x15x9	8029954011636
R500K	Canalina doccia NILO con griglia piastrellabile in acciaio inox mm 501 Shower drain NILO with tileable stainless steel grid mm 501	1	57x15x9	8029954011681
R700K	Canalina doccia NILO con griglia piastrellabile in acciaio inox mm 660 Shower drain NILO with tileable stainless steel grid mm 660	1	75x15x9	8029954011643
R800K	Canalina doccia NILO con griglia piastrellabile in acciaio inox mm 762 Shower drain NILO with tileable stainless steel grid mm 762	1	85x15x9	8029954011650
R900K	Canalina doccia NILO con griglia piastrellabile in acciaio inox mm 862 Shower drain NILO with tileable stainless steel grid mm 862	1	95x15x9	8029954011667



PILETTE DOCCIA SHOWER DRAINS

CR propone una linea dedicata di pilette doccia con modelli a sifone classico o innovativo sifone gravitazionale ribassato

CR offers a dedicated line of shower tray drains with classic syphon models or innovative gravitational and lowered syphon

PILETTA GRAVITAZIONALE GRAVITATIONAL SHOWER TRAY DRAIN



PROFESSIONAL
Line

H 51 mm

RIBASSATA per piatti doccia ultra-sottili
LOWERED for ultra-slim shower trays



DOWNLOAD
Vedi scheda tecnica
View technical sheet

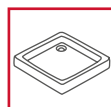

52
l/min



Caratteristiche tecniche

- Piletta adatta a piatti doccia ultra-sottili
- Calotta ricoperta in acciaio inox $\varnothing 120$, foro $\varnothing 90$, uscita $\varnothing 40$
- Completo di filtro capelli removibile per la raccolta di impurit 
- Valvola gravitazionale anti-odori
- Portata: 52 l/min
- Completamente ispezionabile anche da montato
- Accessoriata di viti per l'installazione

Technical features

- Drain suitable for ultra-slim shower-trays
- Stainless steel coat covered $\varnothing 120$, hole $\varnothing 90$, outlet $\varnothing 40$
- Complete of removable filtering grid
- Anti-smell gravitational valve
- Water flow: 52 l/min
- Completely inspectionable also mounted
- Equipped with screws for installation

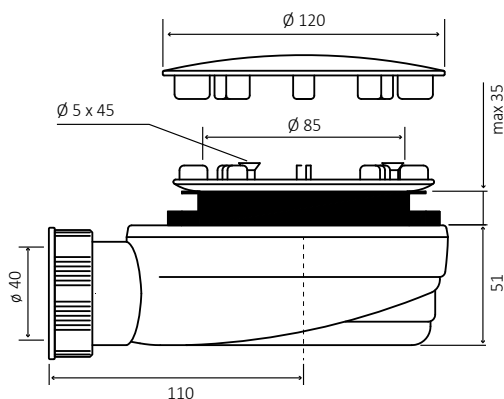

Calotta in acciaio inox

Stainless steel cover



Filtro-capelli removibile

Removable filtering grid

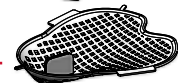

Valvola gravitazionale

Gravitational valve

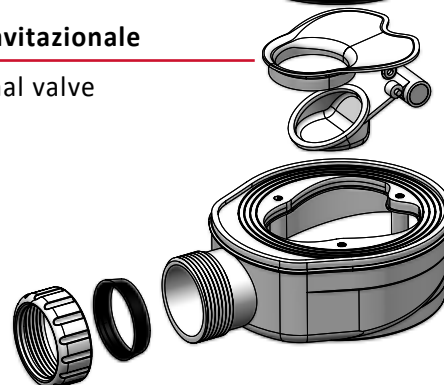

Art. / Item

Descrizione / Models



EAN

5086

Piletta ribassata con calotta inox per piatto doccia con foro da $\varnothing 90$
Lowered siphon waste with stainless steel cover, for shower tray $\varnothing 90$

50

60x40x42

8029954012862

Valvola gravitazionale anti-odori
 Compatibile con piatti doccia filo pavimento
Anti-smell gravitational valve
 Suitable for floor-level shower trays

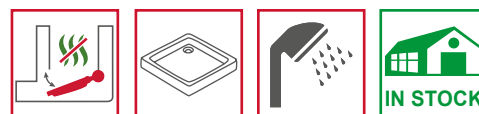

PROFESSIONAL
 Line

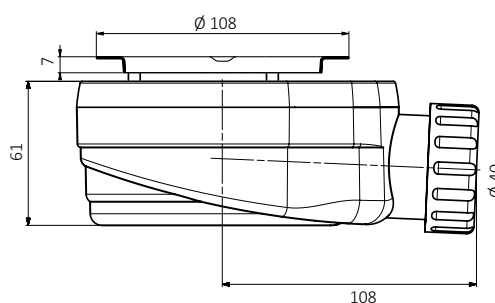

Art. / Item Descrizione / Models

Art. / Item	Descrizione / Models			EAN
5083	Piletta ribassata con valvola gravitazionale e flangia inox per piatto doccia con foro $\varnothing 90$ Lowered siphon waste with gravitational valve and stainless steel flange for shower tray $\varnothing 90$	72	60x40x42	8029954004898

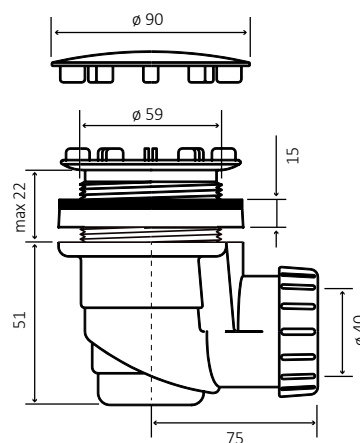

Art. / Item Descrizione / Models

Art. / Item	Descrizione / Models			EAN
5085	Piletta sifonata per piatto doccia con foro $\varnothing 60$, uscita $\varnothing 40$, con calotta in ABS e acciaio inox $\varnothing 90$ Siphon waste for fire clay shower tray with hole $\varnothing 60$, outlet $\varnothing 40$, with stainless steel cover $\varnothing 90$	100	60x40x42	8029954002948

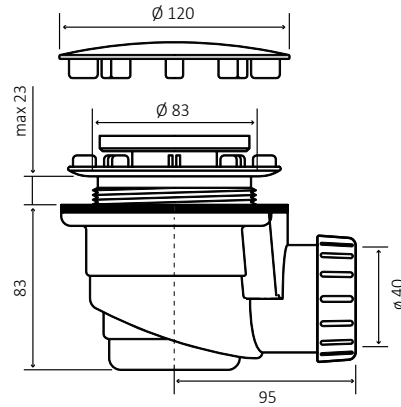

Art. / Item Descrizione / Models



EAN

5084	Piletta sifonata per piatto doccia con foro $\varnothing 90$, uscita $\varnothing 40$, con calotta in ABS e acciaio inox $\varnothing 120$ <i>Siphon waste for fire clay shower tray with hole $\varnothing 90$, outlet $\varnothing 40$, with stainless steel cover $\varnothing 120$</i>	50	60x40x42	8029954002931
------	--	----	----------	---------------

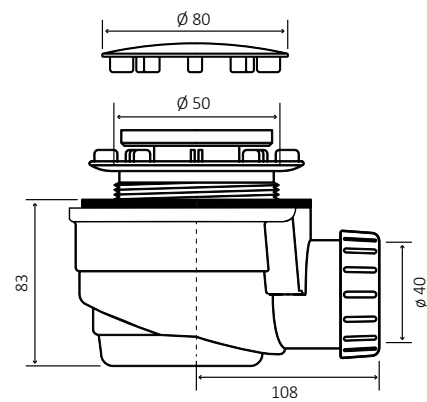

Art. / Item Descrizione / Models



EAN

5082	Piletta sifonata per piatto doccia con foro $\varnothing 50$, uscita $\varnothing 40$, con calotta in ABS e acciaio inox $\varnothing 80$ <i>Siphon waste for fire clay shower tray with hole $\varnothing 50$, outlet $\varnothing 40$, with stainless steel cover $\varnothing 80$</i>	65	60x40x42	8029954002955
------	--	----	----------	---------------

PILETTE PER PIATTO DOCCIA
SHOWER TRAY DRAIN

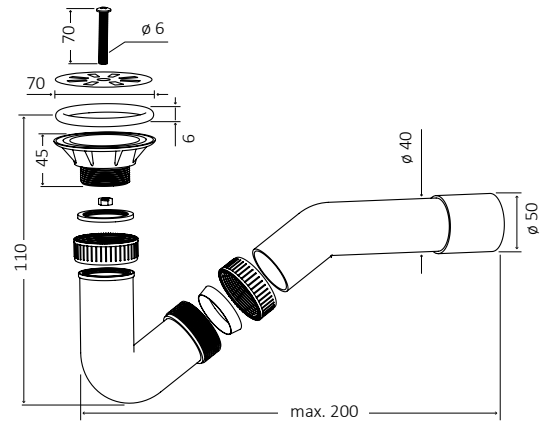

Art. / Item

Descrizione / Models



EAN

5014

Piletta per piatto doccia sifonata, con griglia inox piatta $\varnothing 70$
Siphoned shower tray drain, with stainless steel grid $\varnothing 70$

50

60x40x42

8029954002443

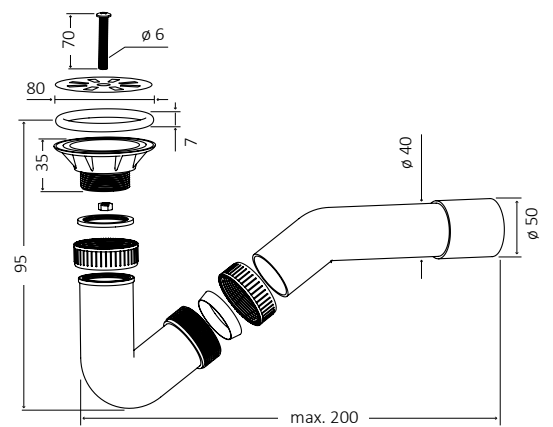

Art. / Item

Descrizione / Models



EAN

5016

Piletta per piatto doccia sifonata, con griglia inox piatta $\varnothing 80$
Siphoned shower tray drain, with stainless steel grid $\varnothing 80$



50

60x40x42

8029954002450

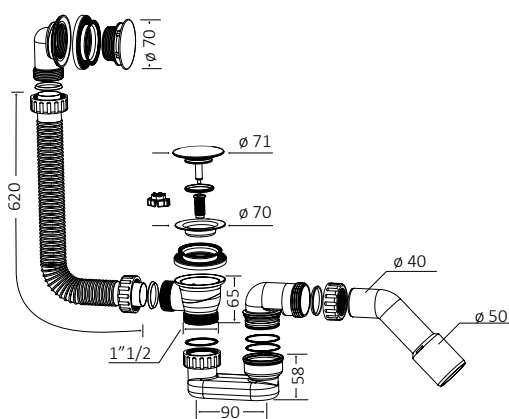
COLONNE VASCA BATHTUB SIPHONS



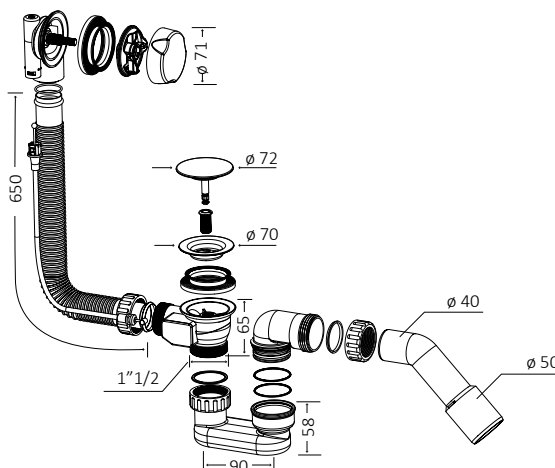

Art. / Item	Descrizione / Models			EAN
5012CL	Colonna vasca con troppopieno cromato e piletta click-clack <i>Bathtub siphon with overflow and click-clack drain</i>	25	60x40x42	8029954007660

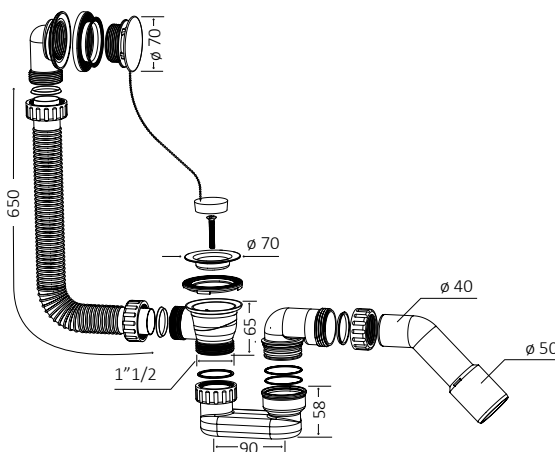

Art. / Item	Descrizione / Models			EAN
5012FPL/02	Colonna vasca automatica con troppopieno cromato <i>Automatic bathtub siphon with chromed overflow</i>	20	60x40x42	8029954012886



Art. / Item	Descrizione / Models			EAN
5012PL	Colonna vasca con troppopieno cromato, tappo e catena <i>Bathtub siphon with overflow, plug and chain</i>	25	60x40x42	8029954012893



Griglia in acciaio inox

Stainless steel grid



Valvola gravitazionale

Gravitational valve

Caratteristiche tecniche

- Installazione a pavimento
- Griglia in acciaio inox 100x100 mm
- Altezza del coperchio riducibile in base alle esigenze di installazione
- Valvola gravitazionale anti-odori
- Portata: 50,5 l/min
- Classe di carico: K3 - 300 kg
- Completamente ispezionabile anche da montato

Technical features

- Floor installation
- Stainless steel grid 100x100 mm
- Reducible height of cover according to installation needs
- Anti-smell gravitational valve
- Water flow: 50,5 l/min
- Charging class: K3 - 300 kg
- Completely inspectionable also mounted

PROFESSIONAL
Line

DOWNLOAD
Vedi scheda tecnica
View technical sheet

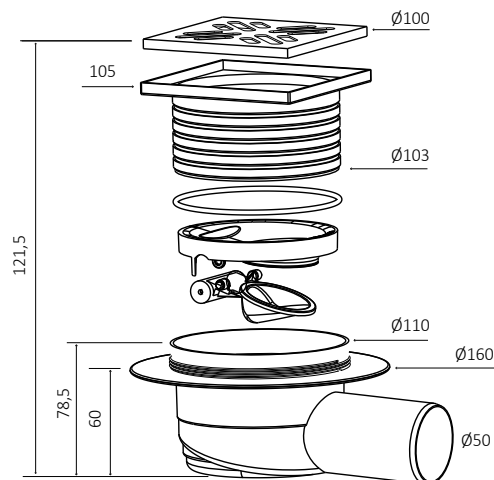

Art. / Item Descrizione / Models



EAN

5087

Chiusino gravitazionale con griglia inox, uscita laterale ø50
Gravitational floor drain with stainless steel grid, side outlet ø50

18

60x40x42



8029954021093

PROFESSIONAL
Line

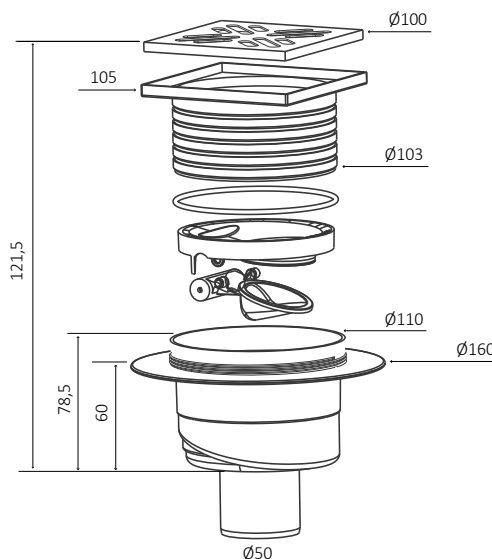

DOWNLOAD
Vedi scheda tecnica
View technical sheet



Art. / Item	Descrizione / Models			EAN
5088	Chiusino gravitazionale con griglia inox, uscita verticale Ø50 Gravitational floor drain with stainless steel grid, vertical outlet Ø50	12	60x40x42	8029954021109

PROFESSIONAL
Line



DOWNLOAD
Vedi scheda tecnica
View technical sheet

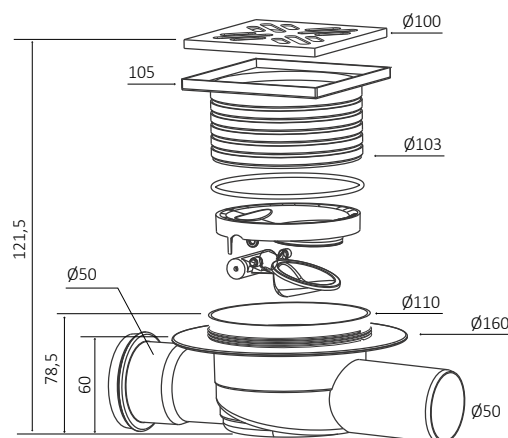

Art. / Item	Descrizione / Models			EAN
5089	Chiusino gravitazionale con griglia inox, entrata-uscita Ø50 Gravitational floor drain with stainless steel grid, inlet-outlet Ø50	15	60x40x42	8029954021116

Griglie cieche e piastrellabili per canaline
Stainless steel blind and tileable grids



Art. / Item	Descrizione / Models		EAN
R400XG	Griglia cieca in acciaio inox mm 398 per canalina doccia Nilo <i>Blind stainless steel grid mm 398 for Nilo shower drain</i>	1	8029954011698
R500XG	Griglia cieca in acciaio inox mm 501 per canalina doccia Nilo <i>Blind stainless steel grid mm 501 for Nilo shower drain</i>	1	8029954011704
R700XG	Griglia cieca in acciaio inox mm 660 per canalina doccia Nilo <i>Blind stainless steel grid mm 660 for Nilo shower drain</i>	1	8029954011711
R800XG	Griglia cieca in acciaio inox mm 762 per canalina doccia Nilo <i>Blind stainless steel grid mm 762 for Nilo shower drain</i>	1	8029954011728
R900XG	Griglia cieca in acciaio inox mm 862 per canalina doccia Nilo <i>Blind stainless steel grid mm 862 for Nilo shower drain</i>	1	8029954011735
R400KG	Griglia piastrellabile in acciaio inox mm 398 per canalina doccia Nilo <i>Tileable stainless steel grid mm 398 for Nilo shower drain</i>	1	8029954011742
R500KG	Griglia piastrellabile in acciaio inox mm 501 per canalina doccia Nilo <i>Tileable stainless steel grid mm 501 for Nilo shower drain</i>	1	8029954011759
R700KG	Griglia piastrellabile in acciaio inox mm 660 per canalina doccia Nilo <i>Tileable stainless steel grid mm 660 for Nilo shower drain</i>	1	8029954011766
R800KG	Griglia piastrellabile in acciaio inox mm 762 per canalina doccia Nilo <i>Tileable stainless steel grid mm 762 for Nilo shower drain</i>	1	8029954011773
R900KG	Griglia piastrellabile in acciaio inox mm 862 per canalina doccia Nilo <i>Tileable stainless steel grid mm 862 for Nilo shower drain</i>	1	8029954011780



Art. / Item	Descrizione / Models			EAN
RVG	Valvola gravitazionale per canalina doccia Nilo <i>Gravitational valve for Nilo shower drain</i>	1		8029954011797



Art. / Item	Descrizione / Models			EAN
5086RVG	Valvola gravitazionale per piletta doccia art.5086 <i>Gravitational valve for shower tray drain art.5086</i>	1		8029954011803



Art. / Item	Descrizione / Models			EAN
5087RVG	Valvola gravitazionale per chiusini sifonati art.5087, 5088, 5089 <i>Gravitational valve for siphoned floor drains art. 5087, 5088, 5089</i>	1		8029954011810

SIFONI PER LAVABO E BIDET

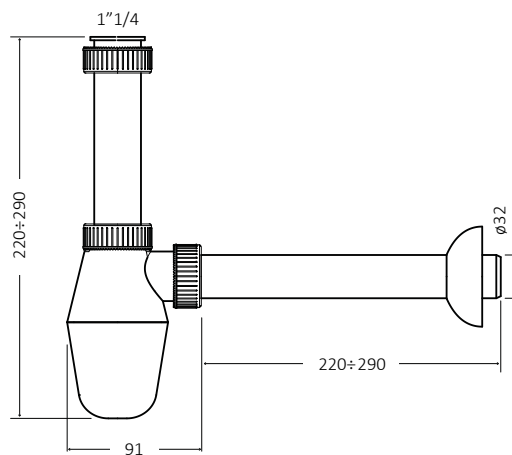

Art. / Item Descrizione / Models



EAN

C1B2

Sifone lavabo a bottiglia, una via, in polipropilene bianco
Washbasin bottle siphon, one way, made of white PP

50

60x40x42

8029954008032

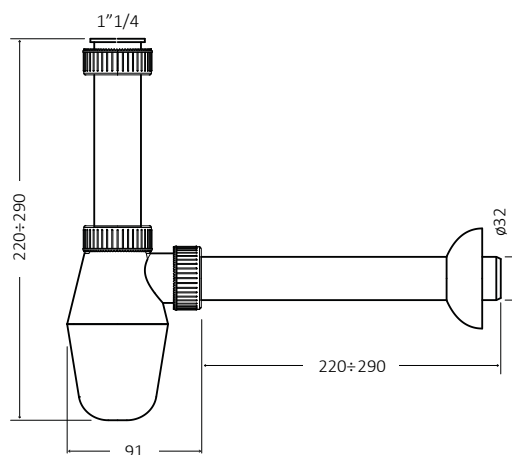

Art. / Item Descrizione / Models



EAN

C1B2-M

Sifone lavabo a bottiglia, una via in polipropilene metallizzato
Washbasin bottle siphon, one way, made of metallized PP

25

60x40x42

8029954008049

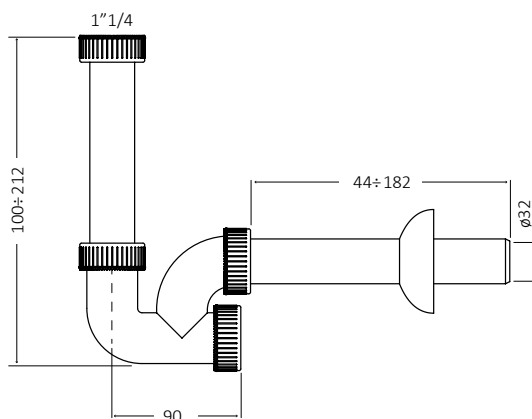

Art. / Item

Descrizione / Models



EAN

C1U3

Sifone lavabo/bidet a U ispezionabile, una via in polipropilene bianco
Washbasin/bidet inspectionable U siphon, one way, made of white PP

50

60x40x42

8029954002283

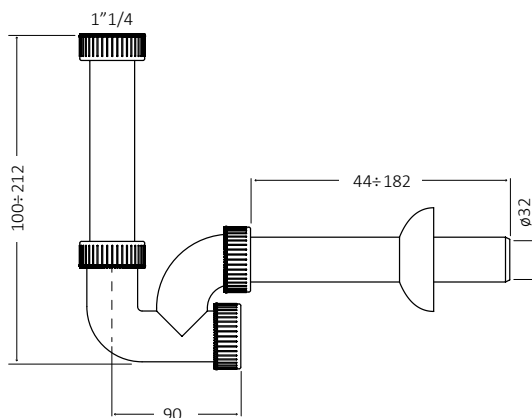

Art. / Item

Descrizione / Models



EAN

C1U3-M

Sifone lavabo/bidet a U ispezionabile, una via in polipropilene metallizzato
Washbasin/bidet inspectionable U siphon, one way, made of metallized PP

25

60x40x42

8029954008025

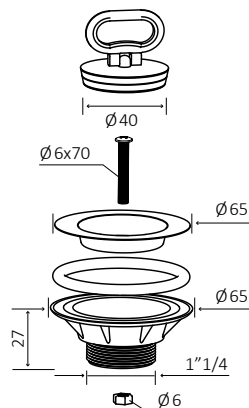

Art. / Item

Descrizione / Models



EAN

CP1C1

Piletta lavabo/bidet 1 1/4, griglia inox 18/8 e ø65, tappo maniglia ø40
Washbasin/bidet drain 1 1/4, stainless steel grate 18/8 e ø65, handle plug ø40

200







60x40x42

8029954008056

TUBI ESTENSIBILI-COMPRIMIBILI









Tubi estensibili-comprimibili in polipropilene con ghiera in plastica
Extensible-flexible pipes made of PP with plastic nut



Art. / Item	Raccordo/Connection	Ø uscita / outlet				EAN	
C1X2	1"	32	150	60x40x42		8029954001934	
C1X3	1"1/4	32	150	60x40x42		8029954079988	
C1X4	1"1/4	32-40	125	60x40x42		8029954001958	
C1X6	1"1/2	32	125	60x40x42		8029954079971	
C1X8	1"1/2	32-40	125	60x40x42		8029954001972	
C1X9	1"1/2	40-50	100	60x40x42		8029954079995	



Tubi estensibili-comprimibili in polipropilene con ghiera in metallo
Extensible-flexible pipes made of PP with metal nut



Art. / Item	Raccordo/Connection	Ø uscita / outlet				EAN	
C1X2M	1"	32	150	60x40x42		8029954001941	
C1X3M	1"1/4	32	150	60x40x42		8029954079964	
C1X4M	1"1/4	32-40	125	60x40x42		8029954001965	
C1X6M	1"1/2	32	125	60x40x42		8029954079957	
C1X8M	1"1/2	32-40	125	60x40x42		8029954001989	
C1X9M	1"1/2	40-50	100	60x40x42		8029954079940	

Tubo estensibile-comprimibile in polipropilene con terminale in ottone
Extensible-flexible pipe made of PP with with brass outlet



Art. / Item	Raccordo/Connection	Ø uscita / outlet				EAN	
C1X10	1"1/4	32	100	60x40x42		8029954079933	

Tubi estensibili-comprimibili in polipropilene metallizzato con ghiera in plastica

Extensible-flexible pipes made of metallized PP with plastic nut









Art. / Item	Raccordo/Connection	Ø uscita / outlet			EAN	
C1X12	1"1/4	32	100	60x40x42	8029954079735	
C1X13	1"1/4	32-40	100	60x40x42	8029954008209	
C1X14	1"1/2	32-40	100	60x40x42	8029954008223	

Tubi estensibili-comprimibili in polipropilene con curva 90° e ghiera in plastica

Extensible-flexible pipes made of PP with bend 90° and plastic nut



Art. / Item	Raccordo/Connection	Ø uscita / outlet			EAN	
C1X17	1"1/4 - 1"1/2	32 - 40	80	60x40x42	8029954079742	
C1X18	1"1/4 - 1"1/2	40 - 50	80	60x40x42	8029954079759	
C1X19	1"1/2	32 - 40	80	60x40x42	8029954079766	
C1X20	1"1/2	40 - 50	80	60x40x42	8029954079773	

Tubi estensibili-comprimibili a due vie in polipropilene, con ghiera in plastica

Extensible-flexible pipes two ways made of PP, with plastic nut





Art. / Item	Raccordo/Connection	Ø uscita / outlet			EAN	
C2X8	1"1/2	32-40	50	60x40x42	8029954079780	
C2X9	1"1/2	40-50	50	60x40x42	8029954079797	

TUBI ESTENSIBILI-COMPRIMIBILI

Tubi estensibili-comprimibili in polipropilene con ghiera in plastica e piletta $\varnothing 65$ con tappo maniglia

Extensible-flexible pipes made of PP with plastic nut and drain $\varnothing 65$ with handle plug





Art. / Item	Raccordo/Connection	\varnothing griglia / \varnothing grid	\varnothing uscita / outlet			EAN
C1X4P1C1	1"1/4	$\varnothing 65$	32-40	60	60x40x42	8029954079803



Tubi estensibili-comprimibili in polipropilene con ghiera in plastica e piletta $\varnothing 70$ con tappo maniglia

Extensible-flexible pipes made of PP with plastic nut and drain $\varnothing 70$ with handle plug





Art. / Item	Raccordo/Connection	\varnothing griglia / \varnothing grid	\varnothing uscita / outlet			EAN
C1X8P3C2	1"1/2	$\varnothing 70$	32-40	50	60x40x42	8029954079810
C1X9P3C2	1"1/2	$\varnothing 70$	40-50	50	60x40x42	8029954079827



Tubi estensibili-comprimibili in polipropilene con ghiera in plastica e piletta $\varnothing 80$ con tappo maniglia

Extensible-flexible pipes made of PP with plastic nut and drain $\varnothing 80$ with handle plug



Art. / Item	Raccordo/Connection	\varnothing griglia / \varnothing grid	\varnothing uscita / outlet			EAN
C1X8P32C2	1"1/2	$\varnothing 80$	32-40	50	60x40x42	8029954079834
C1X9P32C2	1"1/2	$\varnothing 80$	40-50	50	60x40x42	8029954079841



Tubi estensibili-comprimibili in polipropilene con ghiera in plastica e pilettona 3"1/2

Extensible-flexible pipes made of PP with plastic nut and drain 3"1/2



Art. / Item	Raccordo/Connection	\varnothing griglia / \varnothing grid	\varnothing uscita / outlet			EAN
C1X8P68C7	1"1/2	$\varnothing 114$	32-40	50	60x40x42	8029954079858
C1X9P68C7	1"1/2	$\varnothing 114$	40-50	50	60x40x42	8029954079865



Tubi estensibili-comprimibili a due vie in polipropilene, con ghiera in plastica e due pilette $\varnothing 70$ con tappo maniglia

Extensible-flexible pipes two ways made of PP, with plastic nut and two drains $\varnothing 70$ with handle plug



Art. / Item	Raccordo/Connection	\varnothing griglia / \varnothing grid	\varnothing uscita / outlet			EAN
C2X8P3C2	1"1/2	$\varnothing 70$	32-40	25	60x40x42	8029954079872
C2X9P3C2	1"1/2	$\varnothing 70$	40-50	25	60x40x42	8029954079889



Tubi estensibili-comprimibili a due vie in polipropilene, con ghiera in plastica e due pilette $\varnothing 80$ con tappo maniglia

Extensible-flexible pipes two ways made of PP, with plastic nut and two drains $\varnothing 80$ with handle plug



Art. / Item	Raccordo/Connection	\varnothing griglia / \varnothing grid	\varnothing uscita / outlet			EAN
C2X8P32C2	1"1/2	$\varnothing 80$	32-40	25	60x40x42	8029954079896
C2X9P32C2	1"1/2	$\varnothing 80$	40-50	25	60x40x42	8029954079902



Tubi estensibili-comprimibili a due vie in polipropilene, con ghiera in plastica e due piletoni 3"1/2 con tappo maniglia

Extensible-flexible pipes two ways made of PP, with plastic nut and two drains 3"1/2 with handle plug



Art. / Item	Raccordo/Connection	\varnothing griglia / \varnothing grid	\varnothing uscita / outlet			EAN
C2X8P68C7	1"1/2	$\varnothing 114$	32-40	20	60x40x42	8029954079919
C2X9P68C7	1"1/2	$\varnothing 114$	40-50	20	60x40x42	8029954079926





BISCIONE

Tubo flessibile - Flexible pipe



Rotolo da 20 metri
20 meters roll

Art. / Item	Ø interno / internal ø	Ø esterno / external ø			EAN	 IN STOCK
8000-20	26	30	1	52x52x11,5	8029954010998	 IN STOCK
8002-20	31	36	1	54x54x15	8029954011018	 IN STOCK

Raccordi

Raccordi per biscione
Connectors for flexible pipe

Raccordo maschio \varnothing 40 interno

Male connector internal \varnothing 40



Art. / Item	\varnothing uscita \varnothing outlet	Compatibile con rotolo Matching to roll	EAN
8006RS40	40	8002-20	8029954013142

Raccordo maschio \varnothing 32 esterno

Male connector external \varnothing 32



Art. / Item	\varnothing uscita \varnothing outlet	Compatibile con rotolo Matching to roll	EAN
8005	32	8000-20	8029954001859

Raccordo maschio \varnothing 40 esterno

Male connector external \varnothing 40



Art. / Item	\varnothing uscita \varnothing outlet	Compatibile con rotolo Matching to roll	EAN
8006	40	8002-20	8029954001866

Raccordo femmina con dado in plastica da 1"1/4

Female connector with plastic nut 1"1/4



Art. / Item	Raccordo Connection	Compatibile con rotolo Matching to roll	EAN
8008	1"1/4	8000-20	8029954001897

Raccordo femmina con dado in ottone da 1"1/4

Female connector with brass nut 1"1/4



Art. / Item	Raccordo Connection	Compatibile con rotolo Matching to roll	EAN
8008/O	1"1/4	8000-20	8029954001903

Raccordo femmina con dado in plastica da 1"1/2

Female connector with plastic nut 1"1/2



Art. / Item	Raccordo Connection	Compatibile con rotolo Matching to roll	EAN
8009	1"1/2	8002-20	8029954001910

Raccordo femmina con dado in ottone da 1"1/2

Female connector with brass nut 1"1/2



Art. / Item	Raccordo Connection	Compatibile con rotolo Matching to roll	EAN
8009/O	1"1/2	8002-20	8029954001927

LEGENDA



Adatto a lavello inox
Suitable for stainless steel washbasin



Adatto a lavello in ceramica
Suitable for fire-clay washbasin



Adatto a lavatrice
Suitable for washing-machine



Adatto a wc
Suitable for wc

SIFONAME PER CUCINA SIPHONS FOR KITCHEN

Ottimizzazione degli spazi, prevenzione dei cattivi odori, ispezionabilità e resistenza nel tempo sono gli ingredienti della nuova gamma sifoni cucina CR

Optimization of spaces, bad smells prevention, inspectionability and durability are the ingredients of the new CR kitchen siphon range



LEGENDA



Prodotto in stock
Product in stock



Prodotto su richiesta
per grandi quantità
*Product on request
for big quantities*

SIFONI A U

Per lavelli inox e ceramica - For stainless steel and fire-clay sinks

Sifone a U a una via
U siphon, one way

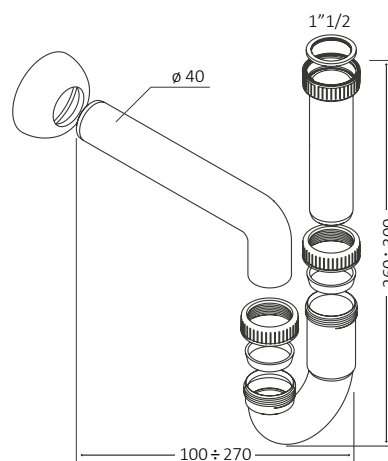
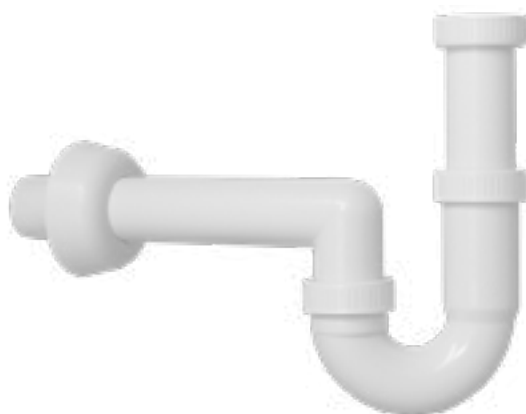

Art. / Item

Raccordo / Connection

ϕ uscita / outlet



60



58,5x39x65,5

EAN

C1U

1"1/2

40

60

58,5x39x65,5

8029954002191

Sifone a U a una via, con attacco lavastoviglie
U siphon, one way, with dishwasher coupling

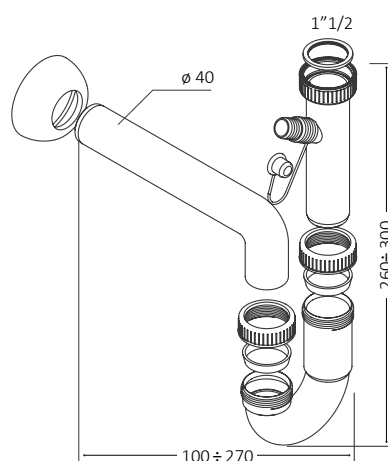

Art. / Item

Raccordo / Connection

ϕ uscita / outlet



60



58,5x39x65,5

EAN

C1UW

1"1/2

40

60

58,5x39x65,5

8029954002214

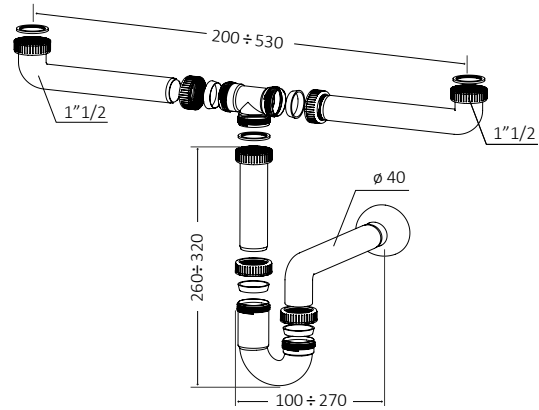

Sifone a U a due vie
U siphon, two ways

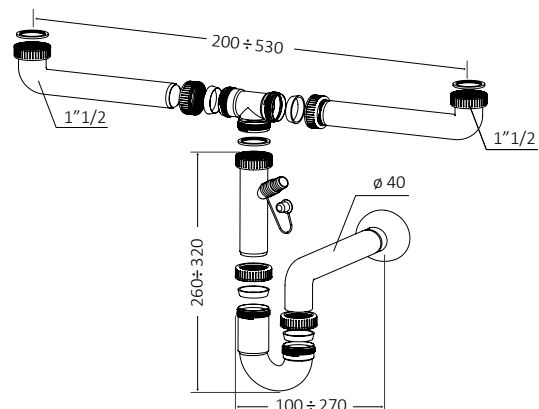

Art. / Item	Raccordo / Connection	ϕ uscita / outlet			EAN
C2U	1"1/2	40	30	58,5x39x65,5	8029954002207

Sifone a U a due vie, con attacco lavastoviglie
U siphon, two ways, with dishwasher coupling



Art. / Item	Raccordo / Connection	ϕ uscita / outlet			EAN
C2UW	1"1/2	40	30	58,5x39x65,5	8029954002221

SIFONI A U CON PILETTA

Per lavelli ceramica - For fire-clay sinks

Sifone a U a una via, con piletta
U siphon, one way, with drain

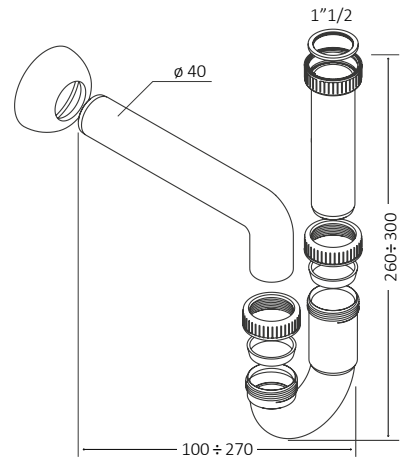

Art. / Item

Raccordo / Connection

Ø griglia / Ø grid

Ø uscita / outlet



EAN

C1UP32C2

1"1/2

Ø80

40

50

58,5x39x65,5

8029954002238

Sifone a U a una via, con attacco lavastoviglie, con piletta
U siphon, one way, with dishwasher coupling, with drain

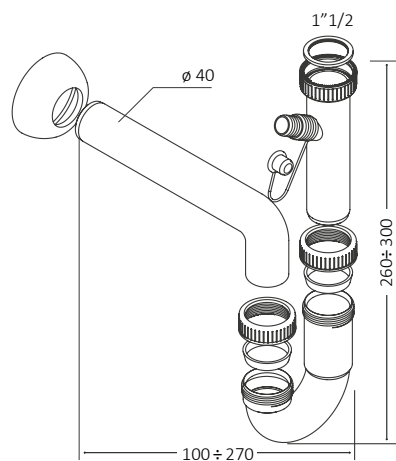

Art. / Item

Raccordo / Connection

Ø griglia / Ø grid

Ø uscita / outlet



EAN

C1UWP32C2

1"1/2

Ø80

40

50

58,5x39x65,5

8029954002252

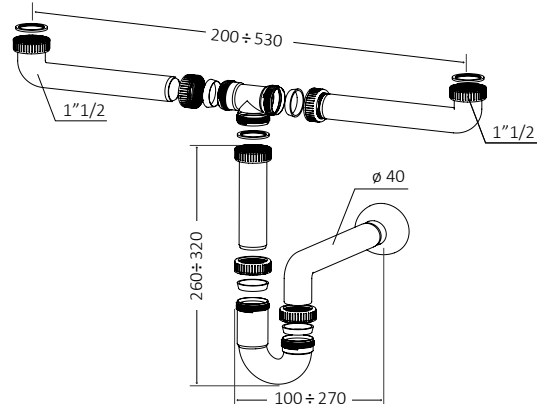

Sifone a U a due vie, con pilette
U siphon, two ways, with drains

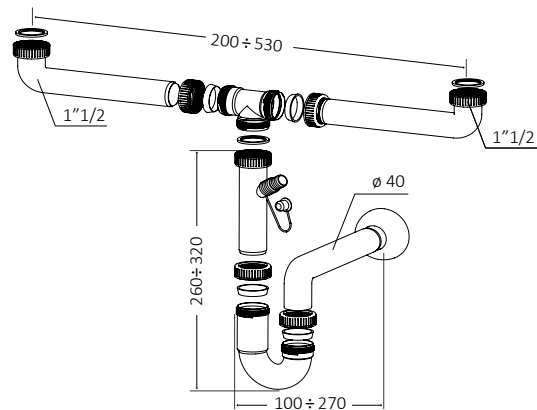

Art. / Item	Raccordo / Connection	ø griglia / ø grid	Ø uscita / outlet			EAN
C2UP32C2	1"1/2	ø80	40	25	58,5x39x65,5	8029954002245

Sifone a U a due vie, con attacco lavastoviglie, con pilette
U siphon, two ways, with dishwasher coupling, with drains



Art. / Item	Raccordo / Connection	ø griglia / ø grid	Ø uscita / outlet			EAN
C2UWP32C2	1"1/2	ø80	40	25	58,5x39x65,5	8029954002269

SIFONI A BOTTIGLIA

Per lavelli inox e ceramica - For stainless steel and fire-clay sinks

Sifone a bottiglia a una via
Bottle siphon, one way

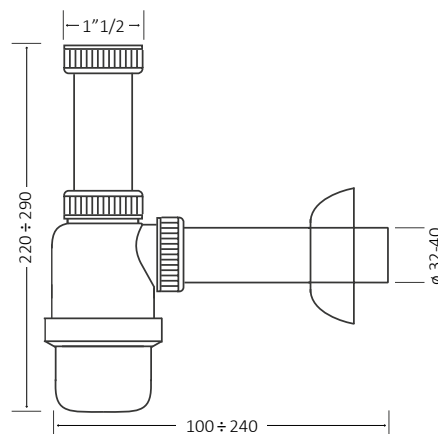

Art. / Item

Raccordo / Connection

Ø uscita / outlet



EAN

C1B

1"1/2

32-40

50

58,5x39x65,5

8029954007943

Sifone a bottiglia a una via, con attacco lavastoviglie
Bottle siphon, one way, with dishwasher coupling

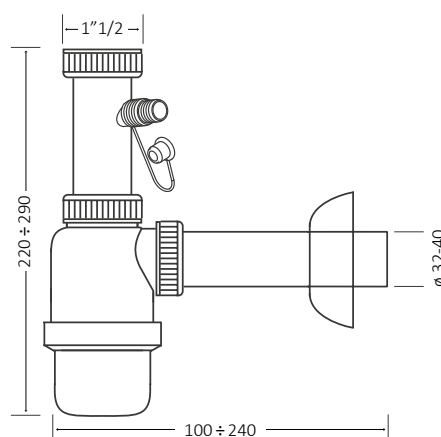

Art. / Item

Raccordo / Connection

Ø uscita / outlet



EAN

C1BW

1"1/2

32-40

50

58,5x39x65,5

8029954007950

Sifone a bottiglia a due vie
 Bottle siphon, two ways

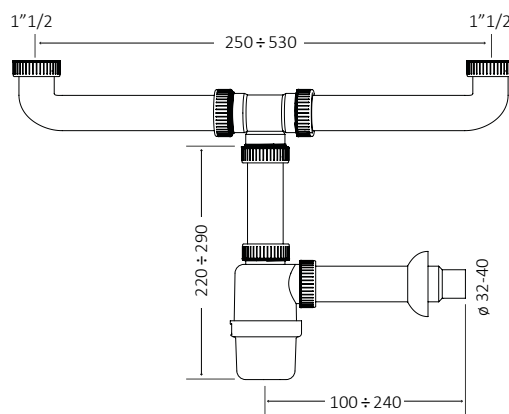

Art. / Item

Raccordo / Connection

Ø uscita / outlet



EAN

C2B

1"1/2

32-40

25

58,5x39x65,5

8029954007967

Sifone a bottiglia a due vie, con attacco lavastoviglie
 Bottle siphon, two ways, with dishwasher coupling

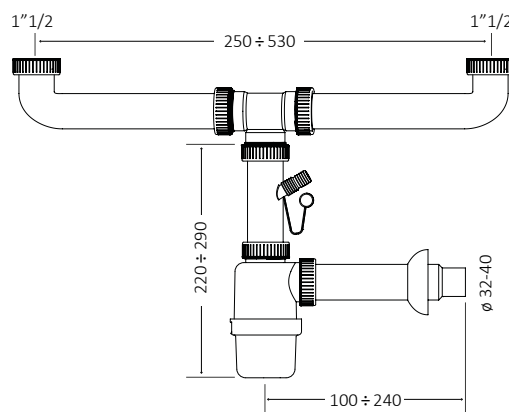

Art. / Item

Raccordo / Connection

Ø uscita / outlet



EAN

C2BW

1"1/2

32-40

25

58,5x39x65,5

8029954007974

SIFONI A BOTTIGLIA CON PILETTA

Per lavelli ceramica - For fire-clay sinks

Sifone a bottiglia a una via, con piletta
Bottle siphon, one way, with drain

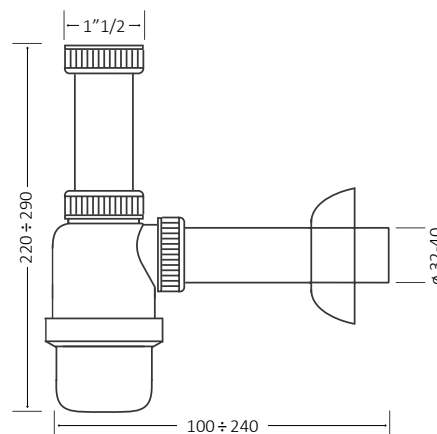

Art. / Item

Raccordo / Connection

Ø griglia / Ø grid

Ø uscita / outlet



EAN

C1BP32C2

1"1/2

Ø80

32-40

50

58,5x39x65,5

8029954007981

Sifone a bottiglia a una via, con attacco lavastoviglie, con piletta
Bottle siphon, one way, with dishwasher coupling, with drain

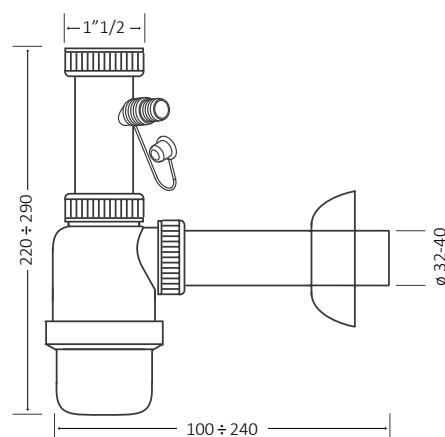

Art. / Item

Raccordo / Connection

Ø griglia / Ø grid

Ø uscita / outlet



EAN

C1BWP32C2

1"1/2

Ø80

32-40

50

58,5x39x65,5

8029954002252

Sifone a bottiglia a due vie, con pilette
 Bottle siphon, two ways, with drains

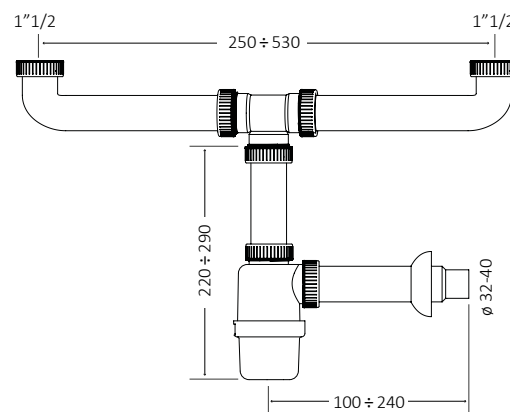

Art. / Item

Raccordo / Connection

Ø griglia / Ø grid

Ø uscita / outlet



EAN

C2BP32C2

1"1/2

Ø80

40

25

58,5x39x65,5

8029954008001

Sifone a bottiglia a due vie, con attacco lavastoviglie, con pilette
 Bottle siphon, two ways, with dishwasher coupling, with drains

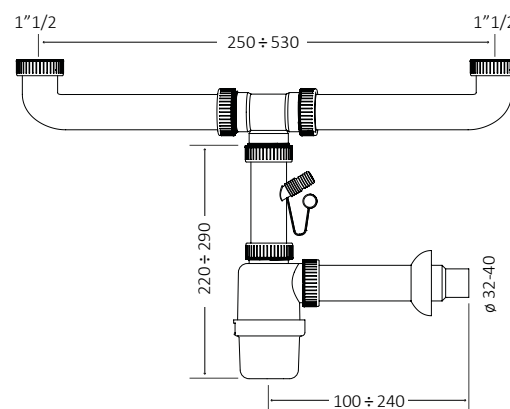

Art. / Item

Raccordo / Connection

Ø griglia / Ø grid

Ø uscita / outlet



EAN

C2BWP32C2

1"1/2

Ø80

40

25

58,5x39x65,5

8029954008018

SIFONI A FIASCO

Per lavelli inox e ceramica - For stainless steel and fire-clay sinks

Sifone a fiasco a una via
Flask siphon, one way

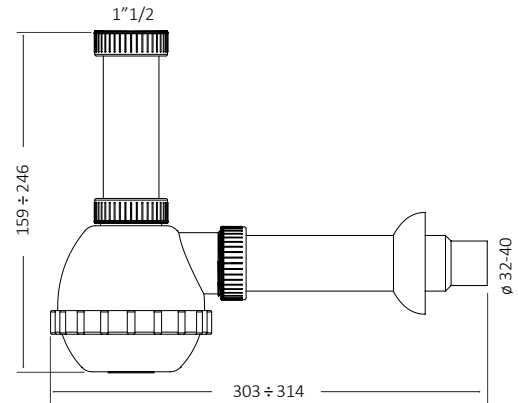

Art. / Item

Raccordo / Connection

Ø uscita / outlet



50



58,5x39x65,5

EAN

8029954002030

Sifone a fiasco a una via, con attacco lavastoviglie
Flask siphon, one way, with dishwasher coupling

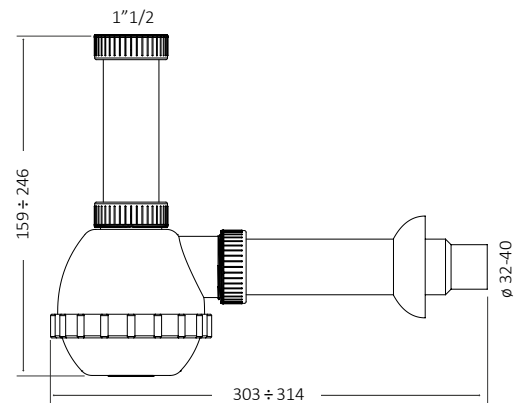
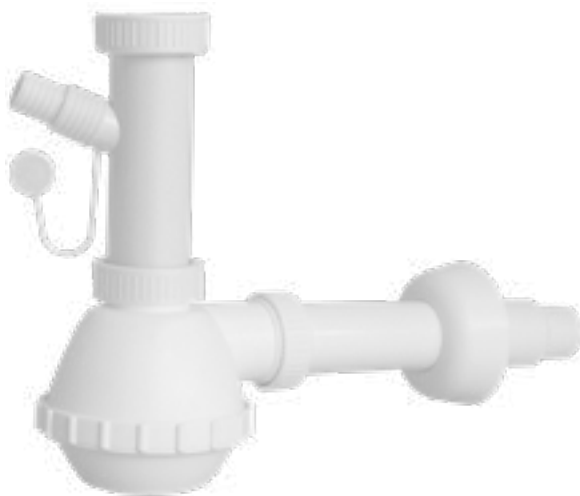

Art. / Item

Raccordo / Connection

Ø uscita / outlet



50



58,5x39x65,5

EAN

8029954002054

Sifone a fiasco a due vie
Flask siphon, two ways

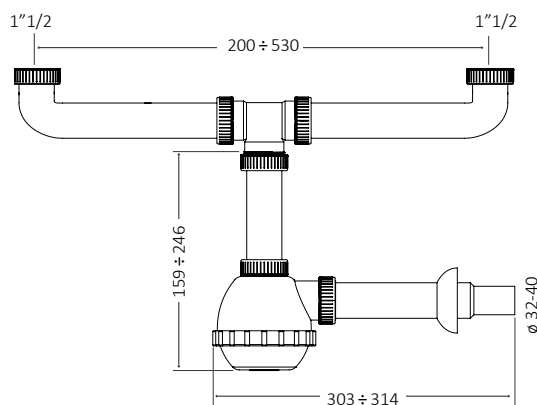

Art. / Item

Raccordo / Connection

Ø uscita / outlet



EAN

C2F

1"1/2

32-40

25

58,5x39x65,5

8029954002047

Sifone a fiasco a due vie, con attacco lavastoviglie
Flask siphon, two ways, with dishwasher coupling

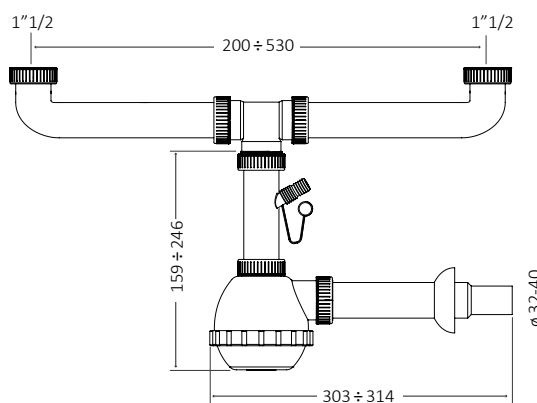

Art. / Item

Raccordo / Connection

Ø uscita / outlet



EAN

C2FW

1"1/2

32-40

25

58,5x39x65,5

8029954002061

SIFONI A FIASCO CON PILETTA

Per lavelli ceramica - For fire-clay sinks

Sifone a fiasco a una via, con piletta
Flask siphon, one way, with drain

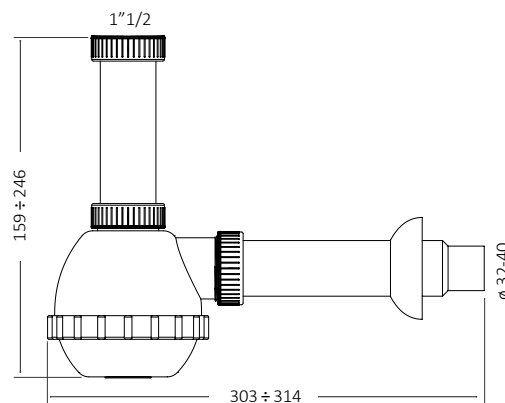

Art. / Item

Raccordo / Connection

Ø griglia / Ø grid

Ø uscita / outlet



EAN

C1FP32C2

1"1/2

Ø80

32-40

40

58,5x39x65,5

8029954002078

Sifone a fiasco a una via, con attacco lavastoviglie, con piletta
Flask siphon, one way, with dishwasher coupling, with drain

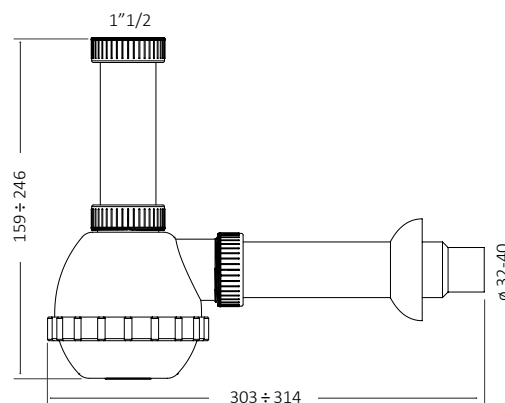

Art. / Item

Raccordo / Connection

Ø griglia / Ø grid

Ø uscita / outlet



EAN

C1FWP32C2

1"1/2

Ø80

32-40

40

58,5x39x65,5

8029954002092

Sifone a fiasco a due vie, con pilette
 Flask siphon, two ways, with drains

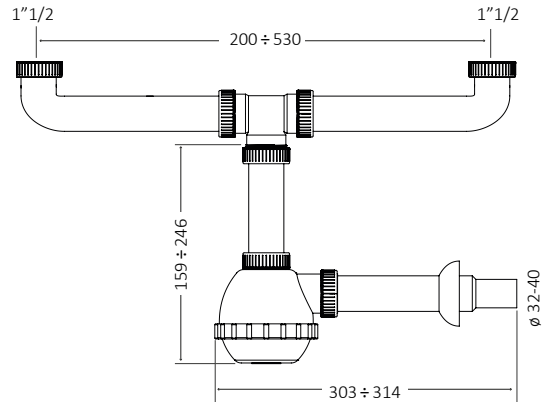

Art. / Item

Raccordo / Connection

Ø griglia / Ø grid

Ø uscita / outlet



EAN

C2FP32C2	1"1/2	Ø80	40	20	58,5x39x65,5	8029954002085
----------	-------	-----	----	----	--------------	---------------

Sifone a fiasco a due vie, con attacco lavastoviglie, con pilett
 Flask siphon, two ways, with dishwasher coupling, with drains

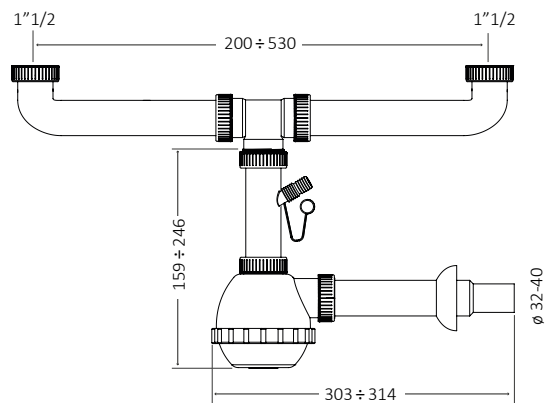

Art. / Item

Raccordo / Connection

Ø griglia / Ø grid

Ø uscita / outlet



EAN

C2FWP32C2	1"1/2	Ø80	40	20	58,5x39x65,5	8029954002108
-----------	-------	-----	----	----	--------------	---------------

SIFONI LIBERI - FREE SIPHONS

Per lavelli inox e ceramica - For stainless steel and fire-clay sinks

Sifone libero a U a una via, con attacco lavastoviglie
Free U siphon, one way, with dishwasher coupling

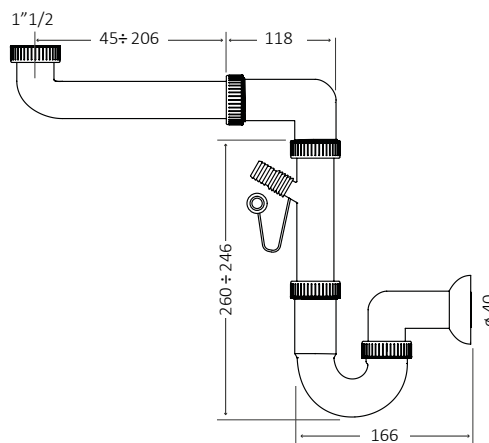

Art. / Item

Raccordo / Connection

Ø uscita / outlet



EAN

Art. / Item	Raccordo / Connection	Ø uscita / outlet			EAN
C1LUW	1"1/2	40	40	58,5x39x65,5	8029954002009
C1LUW-S	1"1/2	40	32	58,5x39x65,5	8029954002597

SCATOLA SINGOLA
SINGLE BOX

Sifone libero a U a due vie, con attacchi lavastoviglie
Free U siphon, two ways, with dishwasher couplings

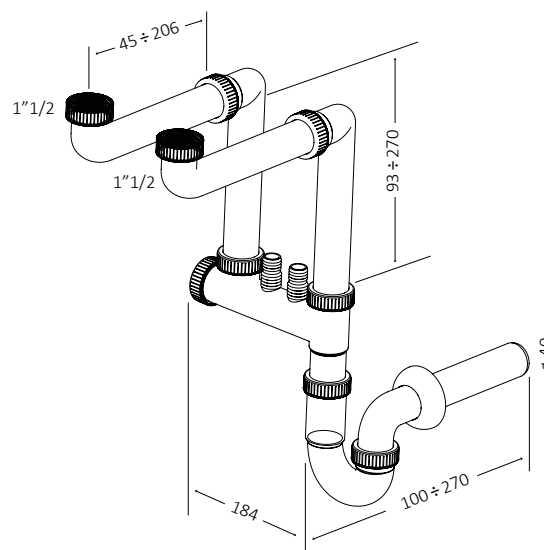
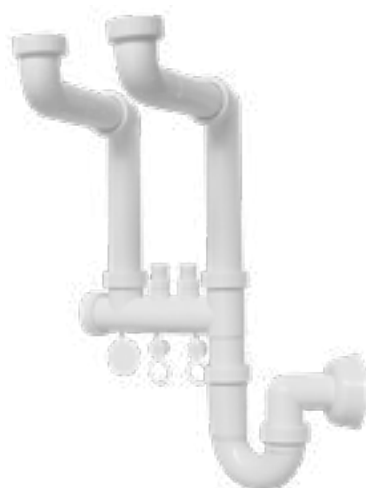

Art. / Item

Raccordo / Connection

Ø uscita / outlet



EAN

Art. / Item	Raccordo / Connection	Ø uscita / outlet			EAN
C2LUW-01	1"1/2	40	25	58,5x39x65,5	8029954002016
C2LUW-01S	1"1/2	40	20	58,5x39x65,5	8029954004652

SCATOLA SINGOLA
SINGLE BOX

PILETTONI 3"1/2 - DRAINS 3"1/2

Per lavelli inox e ceramica - For stainless steel and fire-clay sinks



Pilettoni 3"1/2 con vite da 40 mm, senza troppopieno
 Drain 3"1/2 with screw 40 mm, without overflow

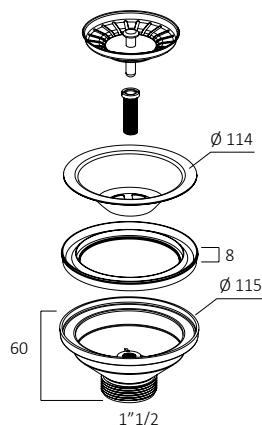

Art. / Item	Raccordo / Connection	Ø griglia/grid			EAN
CP68C7	1"1/2	114	100	60x40x42	8029954002542

Pilettoni 3"1/2 con vite da 40 mm, con troppopieno flessibile
 Drain 3"1/2 with screw 40 mm, with flexible overflow

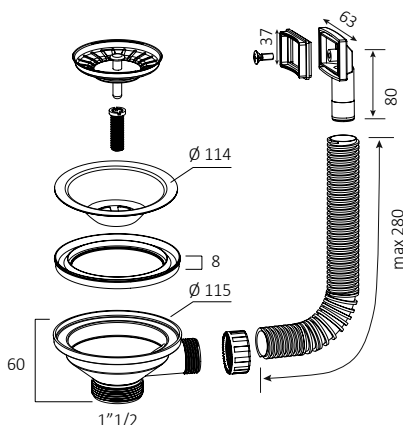

Art. / Item	Raccordo / Connection	Ø griglia/grid			EAN
CP72C7T3	1"1/2	114	50	60x40x42	8029954008070

Pilettoni 3"1/2 con vite da 40 mm, con troppopieno rigido
 Drain 3"1/2 with screw 40 mm, with rigid overflow

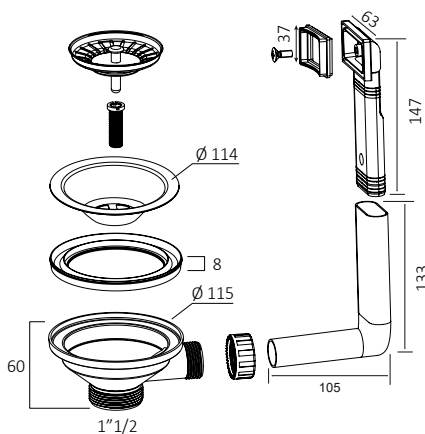

Art. / Item	Raccordo / Connection	Ø griglia/grid			EAN
CP72C7T17	1"1/2	114	50	60x40x42	8029954002535

PILETTE Ø70

Per lavelli inox - For stainless steel sinks

Piletta 1"1/2 con vite da 40 mm, senza troppopieno
 Drain 1"1/2, with screw 40 mm, without overflow

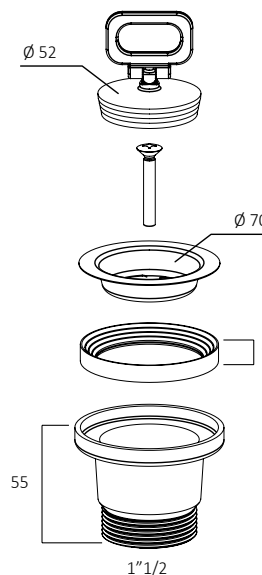

Art. / Item

Raccordo / Connection

Ø griglia / Ø grid



EAN

CP11C2

1"1/2

Ø70

200

60x40x42

8029954002481

Piletta 1"1/2 con vite da 40 mm, con troppopieno flessibile
 Drain 1"1/2, with screw 40 mm and flexible overflow

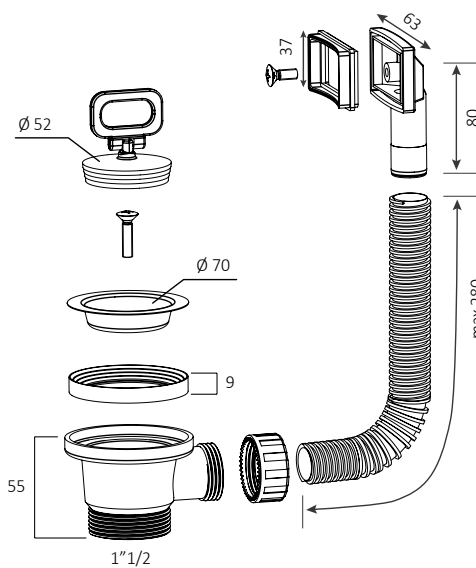

Art. / Item

Raccordo / Connection

Ø griglia / Ø grid



EAN

CP26C2T3

1"1/2

Ø70

90

60x40x42

8029954008063

Piletta 1"1/2 con vite da 40 mm, con troppopieno rigido
 Drain 1"1/2, with screw 40 mm and rigid overflow

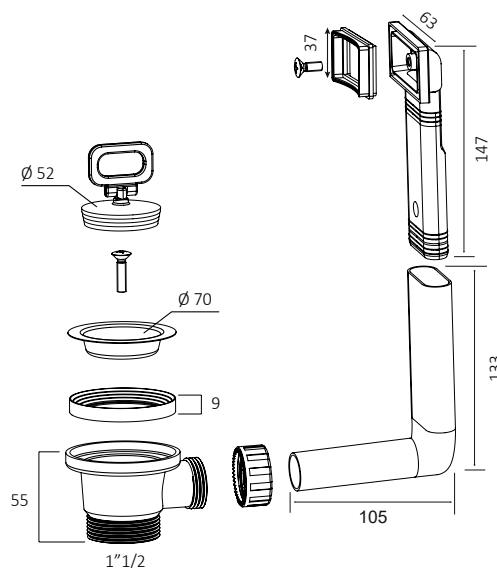

Art. / Item

Raccordo / Connection

Ø griglia / Ø grid



EAN

CP26C2T17

1"1/2

Ø70

90

60x40x42

8029954002498

PILETTE Ø80

Per lavelli ceramica - For fire-clay sinks

Piletta 1"1/2, griglia Ø 80
 Drain 1"1/2, grid Ø80

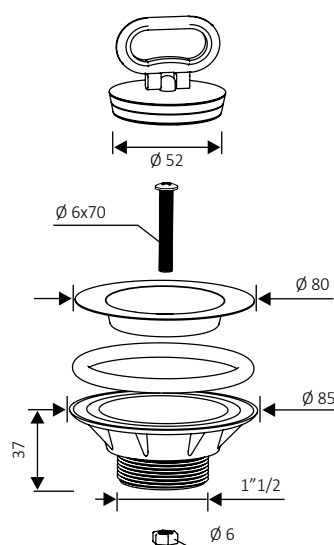

Art. / Item

Raccordo / Connection

Ø griglia / Ø grid



EAN

CP32C2

1"1/2

Ø80

200

60x40x42

8029954002504

SIFONI PER LAVATRICE
SIPHONS FOR WASHING-MACHINE

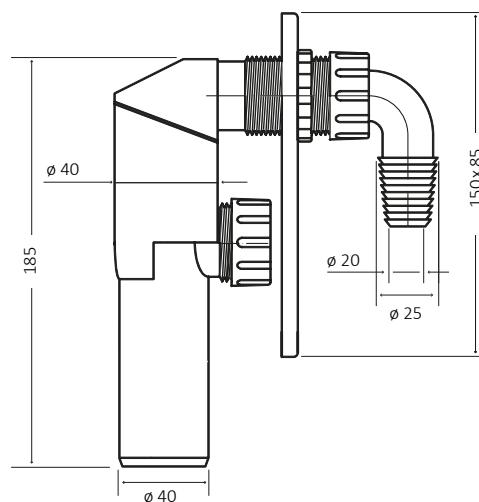

Art. / Item Descrizione / Models



EAN

5111

Sifone incasso lavatrice in polipropilene $\varnothing 40$, con piastra bianca in ABS
Built-in siphon $\varnothing 40$ for washing machine, made of PP, with ABS white plate

100

60x40x42

8029954002573

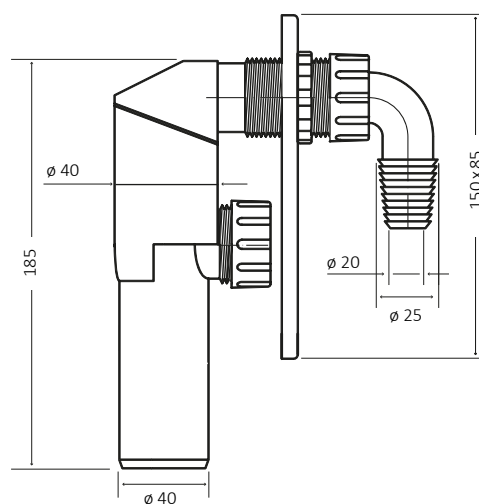

Art. / Item Descrizione / Models



EAN

5112

Sifone incasso lavatrice in polipropilene $\varnothing 40$, con piastra in acciaio inox
Built-in siphon $\varnothing 40$ for washing machine, made of PP, with stainless steel plate

100

60x40x42

8029954002580



Art. / Item Descrizione / Models

EAN

3311-10	Set 10 riduzioni filettate F 1"1/2 x M 1"1/4 Set 10 reductions with thread F 1"1/2 x M 1"1/4	8029954008087	
---------	---	---------------	---



Art. / Item Descrizione / Models

EAN

3310B-10	Set 10 riduzioni filettate F 1"1/4 x M 1"1/2 Set 10 reductions with thread F 1"1/4 x M 1"1/2	8029954008094	
----------	---	---------------	---

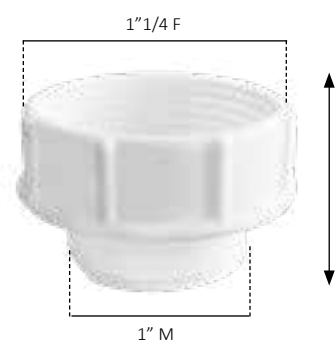

Art. / Item Descrizione / Models

EAN

3312-10	Set 10 riduzioni filettate F 1" 1/4 x M 1" Set 10 reductions with thread F 1" 1/4 x M 1"	8029954008100	
---------	---	---------------	---

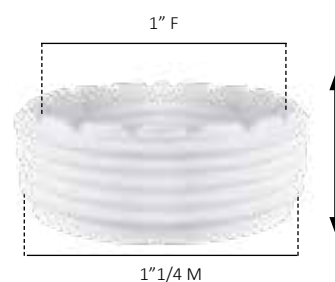

Art. / Item Descrizione / Models

EAN

3313-10	Set 10 riduzioni filettate F 1" interno x M 1"1/4 Set 10 reductions with thread F 1" internal x M 1"1/4	8029954008117	
---------	--	---------------	---



Art. / Item Descrizione / Models

EAN

3310-10	Set 10 riduzioni filettate F 1"1/4 interno x M 1"1/2 Set 10 reductions with thread F 1"1/4 internal x M 1"1/2	8029954008124	
---------	--	---------------	---

SCATTINO

Brevettato
Patented



Vantaggi:



Basta una lieve pressione per chiuderlo e aprirlo

Slight pressure for opening and closing



Funziona anche con l'aiuto di un utensile
It works also by using a tool



Scatta anche in presenza del tappetino di gomma
It works also in presence of the rubber mat



Art. / Item	Descrizione / Models	ø griglia / ø grid	Per piletta / For drain			EAN
SCAT18	Espositore completo di 18 pz Scattino <i>Display with 18 pcs "Scattino"</i>	ø80	3"1/2	2	23,5x23,5x31	8032642520556



















TAPGRIL

Brevettato
Patented



Art. / Item	Descrizione / Models	Ø griglia / Ø grid	Per piletta / For drain			EAN
TAPGR18	Espositore completo di 18 pz Tap-gril Display with 18 pcs "Tap-gril"	Ø50	2"	2	20x20x27	8032642520662

RICAMBI - SPARE PARTS

	Art. / Item	Descrizione / Models	EAN	
 <p>1"1/2</p>	R31	Dado 1"1/2 Nut 1"1/2	8029954002634	
 <p>1"1/2 ø40</p>	R27	Tubo con battuta ø40, 125 mm Pipe ø40, mm 125 with flat band	8029954002641	
 <p>1"1/2 ø40</p>	R5	Prolunga per tubo ø40, 200 mm con dado 1"1/2 Extension pipe ø40, mm 200 with nut 1"1/2	8029954002665	
 <p>ø32 ø40</p>	R21	Tubo di uscita ø40/32 Extension pipe ø40/32	8029954002672	
 <p>1"1/2 ø40</p>	R40	Prolunga per tubo ø40, 150 mm con attacco lavastoviglie Extension pipe ø40, mm 150 with dishwasher coupling	8029954002924	
	M20	Tappo ø52 con maniglia per lavelli inox e ceramica Handle plug ø52 for stainless steel and fire-clay sinks	8029954002740	
	M21	Tappo ø47 catena mm 450 per vasca da bagno Plug ø47 with chain mm 450 for bathtub	8029954002757	
	M22	Tappo ø40 catena mm 250 per lavabo Plug ø40 with chain mm 250 for sink	8029954002764	
	M33	Tappo cestello per pilettoni 3"1/2 Plug for drain 3"1/2	8029954002917	



Art. / Item Descrizione / Models

EAN

GF1-10	Set 10 guarnizioni tonde per sifone a fiasco Set 10 round gaskets for flask siphon	8029954008278	
--------	---	---------------	---



G3-10	Set 10 guarnizioni tonde per pilette per lavelli in ceramica Set 10 round gaskets for fire-clay sink drains	8029954008285	
-------	--	---------------	---



G4-10	Set 10 guarnizioni coniche mm 32 per sifone 1"1/4 Set 10 conical gaskets mm 32 for siphon 1"1/4	8029954008292	
-------	--	---------------	---



G5-10	Set 10 guarnizioni per cestello pilettone 3"1/2 Set 10 gaskets for drain 3"1/2	8029954008308	
-------	---	---------------	---



G7-10	Set 10 guarnizioni piane da 1"1/2 Set 10 flat gaskets 1"1/2	8029954008315	
-------	--	---------------	---



G8-10	Set 10 guarnizioni piane da 1"1/4 Set 10 flat gaskets 1"1/4	8029954008322	
-------	--	---------------	---



G19-10	Set 10 guarnizioni tonde per lavelli inox Set 10 round gaskets for stainless steel sink drains	8029954008339	
--------	---	---------------	---



G24-10	Set 10 guarnizioni coniche mm 40 per sifone 1"1/2 Set 10 conical gaskets mm 40 for trap 1"1/2	8029954008346	
--------	--	---------------	---



M12	Vite in acciaio inox 6x70 mm per pilette per ceramica Stainless steel screw 6x70 mm for fire-clay sink drains	8029954002726	
-----	--	---------------	---



M14	Vite in acciaio inox 6x40 mm per pilette per ceramica Stainless steel screw 6x40 mm for fire-clay sink drains	8029954002733	
-----	--	---------------	---



CHIUSINI SIFONATI



Chiusino sifonato 100x100 uscita ϕ 40
Siphoned trap mm 100x100 outlet ϕ 40



Art. / Item	Dimensioni Dimensions	ϕ uscita esterno ϕ external outlet			EAN	
1700	100x100	40	20	23,5x23x31	8029954001750	



Chiusino sifonato 150x150 uscita ϕ 50-63
Siphoned trap mm 150x150 outlet ϕ 50-63



Art. / Item	Dimensioni Dimensions	ϕ uscita esterno ϕ external outlet			EAN	
1701	150x150	50-63	60	60x40x42	8029954001767	

Chiusino sifonato 200x200 uscita ϕ 75-80
Siphoned trap mm 200x200 outlet ϕ 75-80



Art. / Item	Dimensioni Dimensions	ϕ uscita esterno ϕ external outlet			EAN	
1702	200x200	75-80	24	60x40x42	8029954001774	



Chiusino sifonato 250x250 uscita ϕ 100-110
Siphoned trap mm 250x250 outlet ϕ 100-110



Art. / Item	Dimensioni Dimensions	ϕ uscita esterno ϕ external outlet			EAN	
1703	250x250	100-110	15	60x40x42	8029954001781	

Chiusino sifonato 300x300 uscita ϕ 100-125
Siphoned trap mm 300x300 outlet ϕ 100-125



Art. / Item	Dimensioni Dimensions	ϕ uscita esterno ϕ external outlet			EAN	
1704	300x300	110-125	15	58,5x39x65,5	8029954001798	



Chiusino sifonato 100x100 uscita laterale ϕ 40
Siphoned trap mm 100x100 side outlet ϕ 40



Art. / Item	Dimensioni Dimensions	ϕ uscita esterno ϕ external outlet			EAN	
1705	100x100	40	80	60x40x42	8029954001804	

Chiusino sifonato 150x150 uscita laterale ϕ 50
Siphoned trap mm 150x150 side outlet ϕ 50



Art. / Item	Dimensioni Dimensions	ϕ uscita esterno ϕ external outlet			EAN	
1706	150x150	50	35	60x40x42	8029954001811	

Tubo flessibile uscita wc
Flexible pipe wc outlet

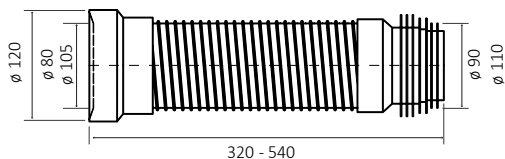

Art. / Item

∅ uscita / outlet



EAN

1220

90-100-110

15

60x40x57,5

8029954001699



Tubo estensibile uscita wc
Extensible pipe wc outlet

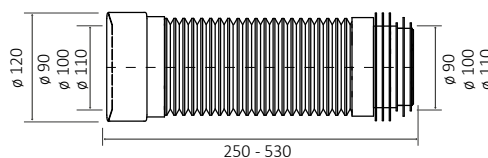

Art. / Item

∅ uscita / outlet



EAN

1221

90-100-110

15

60x40x31

8029954001996



Manicotto concentrico per vaso wc
Concentric wc connector

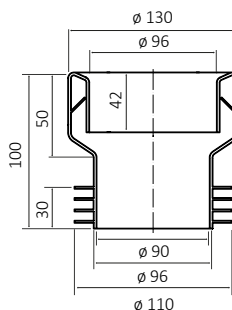

Art. / Item

∅ uscita / outlet



EAN

1641

100-110

60

70,5x40,5x43,5

8029954001705



Manicotto eccentrico per vaso wc
Eccentric wc connector

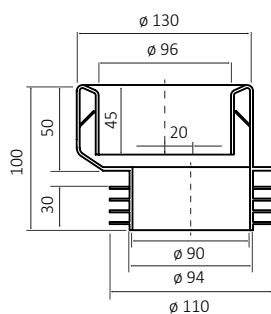

Art. / Item

∅ uscita / outlet



EAN

1641E

100-110

60

70,5x40,5x43,5

8029954001712



LEGENDA

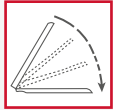

Chiusura rallentata
Soft-close



Facilmente removibile
Quick-release



Fissaggio cerniere dall'alto
compatibile con vasi a filo muro
*Top-fix hinges suitable for
back-to-wall wc pans*

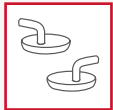

Cerniere inox
Stainless steel hinges



Montaggio semplice e veloce
Easy and fast mounting

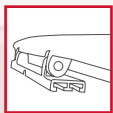

Cerniera uniblock
Uniblock hinge



Adatto a vasi per bambini
Suitable for children wc bowls

SEDILI WC TOILET SEATS

La linea sedili CR: praticità di installazione, durevolezza, resistenza e compatibilità universale al classico vaso porcellana o al moderno vaso a filo muro

The CR toilet seats range: easy installation, durability, resistance and universal compatibility to the classic porcelain bowl or the modern back-to-wall wc pan



EVEREST

Soft close

Rallentato



Soft close

Sgancio rapido



Quick release

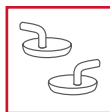

DOWNLOAD

Vedi scheda tecnica
View technical sheet

PROFESSIONAL

Line



Caratteristiche tecniche

- Sedile wc universale
- Materiale: termoundurente
- Peso: 1,820 kg
- Chiusura rallentata
- Sgancio rapido
- Cerniere con fissaggio dall'alto

Technical features

- Universal toilet seat
- Material: duroplast
- Weight: 1,820 kg
- Soft close
- Take-off system
- Top-fix hinges

Ricambi - Spare parts (Dettagli - Details pag. 183-185)



1545HTF Cerniere con fissaggio dall'alto - Top fix hinges



1546SC Paracolpi - Buffers

Art. / Item

Descrizione / Models

EAN

1108SC

Sedile EVEREST con chiusura rallentata e sgancio rapido
EVEREST toilet seat with soft-close and removable take-off system

8029954001446

Info packing

<p>Dimensioni prodotto singolo Single product dimensions</p>	46x38x5,5	<p>N° scatole master su pallet N° master box on a pallet</p>	24	<p>N° pezzi singoli in cartone master N° single pieces in a master box</p>	7
<p>Peso pezzo singolo Weight single piece</p>	2,14	<p>Dimensioni pallet Pallet dimensions</p>	80x120x200	<p>Dimensioni cartone master Master box dimensions</p>	40x39x48

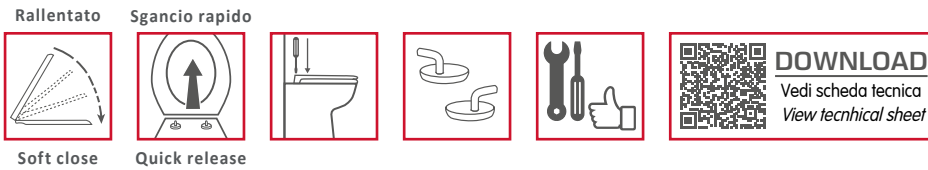

PROFESSIONAL
Line





Caratteristiche tecniche

- Sedile wc universale
- Materiale: termoindurente
- Peso: 2,200 kg
- Chiusura rallentata
- Sgancio rapido
- Cerniere con fissaggio dall'alto

Technical features







- Universal toilet seat
- Material: duroplast
- Weight: 2,200 kg
- Soft close
- Take-off system
- Top-fix hinges

Ricambi - Spare parts (Dettagli - Details pag. 183-185)

	1545NTF	Cerniere con fissaggio dall'alto - <i>Top fix hinges</i>
	1546F	Paracolpi - <i>Buffers</i>

Art. / Item	Descrizione / Models	EAN
1108F	Sedile JAVA con chiusura rallentata e sgancio rapido JAVA toilet seat with soft-close and removable take-off system	8029954032068

Info packing

 Dimensioni prodotto singolo Single product dimensions	46x38x5,5	 N° scatole master su pallet N° master box on a pallet	24	 N° pezzi singoli in cartone master N° single pieces in a master box	7
 Peso pezzo singolo Weight single piece	2,52	 Dimensioni pallet Pallet dimensions	80x120x200	 Dimensioni cartone master Master box dimensions	40x39x48

MALAGA

Soft close

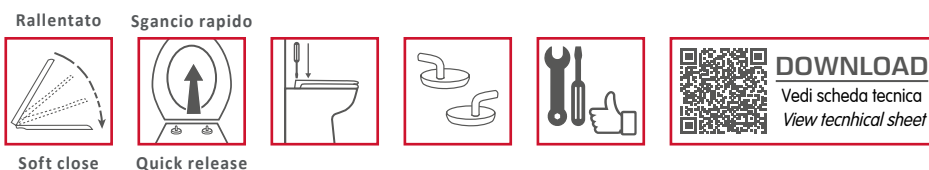

PROFESSIONAL
Line





Caratteristiche tecniche

- Materiale: termoindurente
- Peso: 2,120 kg
- Chiusura rallentata
- Sgancio rapido
- Cerniere con fissaggio dall'alto

Technical features







- Material: duroplast
- Weight: 2,120 kg
- Soft close
- Take-off system
- Top-fix hinges

Ricambi - Spare parts (Dettagli - Details pag. 183-185)

	1545HTF	Cerniere con fissaggio dall'alto - <i>Top fix hinges</i>
	1546G	Paracolpi - <i>Buffers</i>

Art. / Item	Descrizione / Models	EAN
1108G	Sedile MALAGA con chiusura rallentata e sgancio rapido <i>MALAGA toilet seat with soft-close and removable take-off system</i>	8029954032099

Info packing

 Dimensioni prodotto singolo <i>Single product dimensions</i>	46x38x5,5	 N° scatole master su pallet <i>N° master box on a pallet</i>	24	 N° pezzi singoli in cartone master <i>N° single pieces in a master box</i>	7
 Peso pezzo singolo <i>Weight single piece</i>	2,44	 Dimensioni pallet <i>Pallet dimensions</i>	80x120x200	 Dimensioni cartone master <i>Master box dimensions</i>	40x39x48

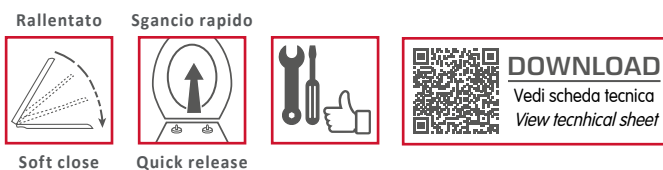

PROFESSIONAL Line



Caratteristiche tecniche

- Sedile wc universale
- Materiale: resina infrangibile PP
- Peso: 1,440 kg
- Chiusura rallentata
- Sgancio rapido

Technical features

- Universal toilet seat
- Material: unbreakable PP resin
- Weight: 1,440 kg
- Soft close
- Take-off system

Ricambi - Spare parts (Dettagli - Details pag. 184-185)



1545S Cerniere - Hinges



1546E Paracolpi - Buffers







Art. / Item

Descrizione / Models

EAN

1108E	Sedile CRETA con chiusura rallentata e sgancio rapido CRETA toilet seat with soft-close and removable take-off system	8029954032037
-------	--	---------------

Info packing

 <p>Dimensioni prodotto singolo Single product dimensions</p>	46x38x5,5	 <p>N° scatole master su pallet N° master box on a pallet</p>	24	 <p>N° pezzi singoli in cartone master N° single pieces in a master box</p>	7
 <p>Peso pezzo singolo Weight single piece</p>	1,76	 <p>Dimensioni pallet Pallet dimensions</p>	80x120x200	 <p>Dimensioni cartone master Master box dimensions</p>	40x39x48

KOMODO

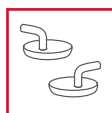

Caratteristiche tecniche

- Sedile wc universale
- Materiale: termoplastico
- Peso: 1,980 kg
- Cerniere in acciaio inox regolabili

Technical features

- Universal toilet seat
- Material: duroplast
- Weight: 1,980 kg
- Adjustable stainless steel hinges

Ricambi - Spare parts (Dettagli - Details pag. 183)



1545G Cerniere con fissaggio dall'alto - Top fix hinges

Art. / Item

Descrizione / Models

EAN

1108X

Sedile KOMODO con cerniere in acciaio inox
KOMODO toilet seat with stainless steel hinges

8029954001422

Info packing

Dimensioni prodotto singolo Single product dimensions	46x38x5	N° scatole master su pallet N° master box on a pallet	36	N° pezzi singoli in cartone master N° single pieces in a master box	6
Peso pezzo singolo Weight single piece	2,23	Dimensioni pallet Pallet dimensions	100x120x205	Dimensioni cartone master Master box dimensions	39x33x48

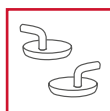
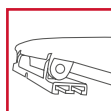

DOWNLOAD

Vedi scheda tecnica
View technical sheet



410÷465

130÷185

365



Ricambi - Spare parts (Dettagli - Details pag. 182-185)



1545B

Cerniere - Hinges



1545F

Cerniere inox - Stainless steel hinges



1546E

Paracolpi - Buffers



1545QF - 1549

Kit di fissaggio - Fixing kit

Caratteristiche tecniche

- Sedile wc universale
- Materiale: resina infrangibile PP
- Peso: 1,700 kg
- Cerniera uniblock regolabile
- Disponibile anche con cerniere in acciaio inox

Technical features

- Universal toilet seat
- Material: unbreakable PP resin
- Weight: 1,700 kg
- Adjustable uniblock hinge
- Available also with stainless steel hinges





Art. / Item

Descrizione / Models

EAN

Art. / Item	Descrizione / Models	EAN
1104	Sedile BOXER con cerniera uniblock BOXER toilet seat with uniblock hinge	8029954004638
1104X	Sedile BOXER con cerniere inox BOXER toilet seat with stainless steel hinges	8029954004645

Info packing

 Dimensioni prodotto singolo Single product dimensions		48x38x6	 N° scatole master su pallet N° master box on a pallet	20	 N° pezzi singoli in cartone master N° single pieces in a master box	9
	 Peso pezzo singolo Weight single piece	1104		1,88		 Dimensioni pallet Pallet dimensions
1104X		1,96				

K2 EVO

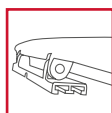

DOWNLOAD

Vedi scheda tecnica
View technical sheet



420-450

130÷185

368



Ricambi - Spare parts (Dettagli - Details pag. 182-185)

	1545B	Cerniere - Hinges
	1545L	Cerniere inox - Stainless steel hinges
	1546B	Paracolpi - Buffers
	1545QF - 1549	Kit di fissaggio - Fixing kit

Caratteristiche tecniche

- Sedile wc universale
- Materiale: resina infrangibile PP
- Peso: 1,200 kg
- Cerniera uniblock a 4 regolazioni
- Disponibile versione con cerniere inox

Technical features

- Universal toilet seat
- Material: unbreakable PP resin
- Weight: 1,200 kg
- Adjustable uniblock hinge
- Available version with stainless steel hinges

Art. / Item	Descrizione / Models	EAN
1109	Sedile K2 EVO bianco con cerniera uniblock White wc seat K2 EVO with uniblock hinge	8029954001392
1109X	Sedile K2 EVO bianco con cerniere inox White wc seat K2 EVO with stainless steel hinges	8029954080274

Info packing

Dimensioni prodotto singolo Single product dimensions cm	47x38x6		N° scatole master su pallet N° master box on a pallet	20	N° pezzi singoli in cartone master N° single pieces in a master box	9
	Peso pezzo singolo Weight single piece Kg	1109				
1109X		1,38				

K2 CLASSIC

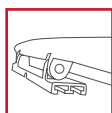

DOWNLOAD

Vedi scheda tecnica
View technical sheet



Ricambi - Spare parts (Dettagli - Details pag. 182-185)

	1545	Cerniere - Hinges
	1546	Paracolpi - Buffers
	1545QF - 1549	Kit di fissaggio - Fixing kit

Caratteristiche tecniche

- Sedile wc universale
- Materiale: resina infrangibile ABS
- Peso: 1,200 kg
- Maniglia per sollevamento coperchio
- Cerniera uniblock a 4 regolazioni

Technical features

- Universal toilet seat
- Material: unbreakable ABS resin
- Weight: 1,200 kg
- Cover complete with handle
- Adjustable uniblock hinge

Art. / Item	Descrizione / Models	Colore / Colour	EAN
1107	Sedile K2 bianco con cerniera uniblock White wc seat K2 with uniblock hinge		8029954001286
1107CH	Sedile K2 champagne con cerniera uniblock Champagne wc seat K2 with uniblock hinge		8029954001316

Info packing

Dimensioni prodotto singolo Single product dimensions	48x38x6	N° scatole master su pallet N° master box on a pallet	20	N° pezzi singoli in cartone master N° single pieces in a master box	9
Peso pezzo singolo Weight single piece	1,28	Dimensioni pallet Pallet dimensions	100x120x210	Dimensioni cartone master Master box dimensions	59x39x50

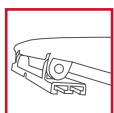

DOWNLOAD

Vedi scheda tecnica
View technical sheet



420-450

130±185

370



Caratteristiche tecniche

- Sedile wc universale
- Materiale: resina infrangibile PP
- Peso: 0,650 kg
- Cerniera uniblock a 4 regolazioni

Ricambi - Spare parts (Dettagli - Details pag. 182-185)



1545

Cerniere - Hinges



1545QF - 1549

Kit di fissaggio - Fixing kit

Technical features

- Universal toilet seat
- Material: unbreakable PP resin
- Weight: 0,650 kg
- Adjustable uniblock hinge

Art. / Item

Descrizione / Models

EAN

1100

Sedile ATLANTIC bianco con cerniera uniblock
White wc seat ATLANTIC with uniblock hinge

8029954001392

Info packing

<p>Dimensioni prodotto singolo Single product dimensions</p>	45x38x7	<p>N° scatole master su pallet N° master box on a pallet</p>	24	<p>N° pezzi singoli in cartone master N° single pieces in a master box</p>	10
<p>Peso pezzo singolo Weight single piece</p>	0,65	<p>Dimensioni pallet Pallet dimensions</p>	80x120x200	<p>Dimensioni cartone master Master box dimensions</p>	53x38x46

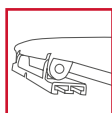

DOWNLOAD

Vedi scheda tecnica
View technical sheet



Caratteristiche tecniche

- Sedile wc universale
- Materiale: resina infrangibile PP
- Peso: 0,850 kg
- Cerniera uniblock a 4 regolazioni e viti in resina

Ricambi - Spare parts (Dettagli - Details pag. 182-185)



1545

Cerniere - Hinges



1545QF - 1549

Kit di fissaggio - Fixing kit

Technical features

- Universal toilet seat
- Material: unbreakable PP resin
- Weight: 0,850 kg
- Adjustable uniblock hinge

Art. / Item

Descrizione / Models







EAN

1105

Sedile Z3 bianco con cerniera uniblock
White wc seat Z3 with uniblock hinge

8029954200108

Info packing

 <p>Dimensioni prodotto singolo Single product dimensions</p>	47x36x4,5	 <p>N° scatole master su pallet N° master box on a pallet</p>	24	 <p>N° pezzi singoli in cartone master N° single pieces in a master box</p>	15
 <p>Peso pezzo singolo Weight single piece</p>	0,85	 <p>Dimensioni pallet Pallet dimensions</p>	80x120x200	 <p>Dimensioni cartone master Master box dimensions</p>	48x37x47

BABY

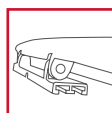

Caratteristiche tecniche

- Sedile wc per vasi wc per bambini
- Materiale: resina infrangibile
- Peso: 0,566 kg
- Cerniera uniblock a 4 regolazioni

Technical features

- Toilet seat suitable to children bowls
- Material: unbreakable resin
- Weight: 0,566 kg
- Adjustable uniblock hinge

Ricambi - Spare parts (Dettagli - Details pag. 182-185)

	1545B	Cerniere - Hinges
	1546B	Paracolpi - Buffers
	1545QF - 1549	Kit di fissaggio - Fixing kit

Art. / Item Descrizione / Models

EAN

1103	Sedile BABY bianco con cerniera uniblock White wc seat BABY with uniblock hinge	8029954040728
------	--	---------------

Info packing

Dimensioni prodotto singolo Single product dimensions	38x30,5x5	N° scatole master su pallet N° master box on a pallet	30	N° pezzi singoli in cartone master N° single pieces in a master box	7
Peso pezzo singolo Weight single piece	0,69	Dimensioni pallet Pallet dimensions	80x120x185	Dimensioni cartone master Master box dimensions	39x37x33

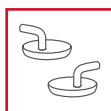

DOWNLOAD

Vedi scheda tecnica
View technical sheet



Caratteristiche tecniche

- Sedile wc universale
- Materiale: legno verniciato bianco
- Peso: 3,600 kg
- Cerniere e viti di fissaggio in metallo

Technical features

- Universal toilet seat
- Material: white varnished wood
- Weight: 3,600 kg
- Metal fastenings and screws

Ricambi - Spare parts (Dettagli - Details pag. 182)



1545E

Cerniere - Hinges

Art. / Item

Descrizione / Models







EAN

1106

Sedile LEGNO bianco con cerniere e viti in metallo
White wood wc seat with metal fastenings and screws

8029954001279

Info packing

 <p>Dimensioni prodotto singolo Single product dimensions</p>	46x38x6	 <p>N° scatole master su pallet N° master box on a pallet</p>	48	 <p>N° pezzi singoli in cartone master N° single pieces in a master box</p>	4
 <p>Peso pezzo singolo Weight single piece</p>	3,90	 <p>Dimensioni pallet Pallet dimensions</p>	107x120x200	 <p>Dimensioni cartone master Master box dimensions</p>	39x26x47

Ricambi per sedili wc Spare parts for toilet seats



Cerniera uniblock con viti e galletti per sedili / *Uniblock hinge an fixing kit for toilet seats:*
K2 Evo 1109, K2 Classic 1107, Z3 1105, Atlantic 1100, Baby 1103

Art. / Item	Descrizione / Models	EAN
1545	Cerniera uniblock <i>Uniblock hinge</i>	8029954004515



Cerniera uniblock per sedile Boxer 1104
Uniblock hinge for toilet seat Boxer 1104

Art. / Item	Descrizione / Models	EAN
1545B	Cerniera uniblock <i>Uniblock hinge</i>	8029954004614



Set cerniere universali per sedili in legno
Universal hinges for wood toilet seats

Art. / Item	Descrizione / Models	EAN
1545E	Set cerniere <i>Set hinges</i>	8029954004607



Set cerniere inox per sedile Boxer 1104X
Stainless steel hinges for toilet seat Boxer 1104X

Art. / Item	Descrizione / Models	EAN
1545F	Set cerniere inox <i>Stainless steel hinges</i>	8029954057221



Set cerniere per sedile Komodo 1108X
Set hinges for toilet seat Komodo 1108X

Art. / Item	Descrizione / Models	EAN
1545G	Set cerniere <i>Set hinges</i>	8029954057214



Set cerniere take-off, top fix per sedili: Malaga 1108G e Everest soft close 1108SC
Set hinges take-off and top fix for toilet seats: Malaga 1108G and Everest soft close 1108SC

Art. / Item	Descrizione / Models	EAN
1545HTF	Set cerniere take-off, top fix <i>Set hinges take-off and top fix</i>	8029954093557



Set cerniere inox per sedile K2 Evo 1109X
Stainless steel hinges for toilet seat K2 Evo 1109X

Art. / Item	Descrizione / Models	EAN
1545L	Set cerniere inox <i>Stainless steel hinges</i>	8029954012473



Set cerniere take-off, top fix per sedile Java 1108F
Set hinges take-off and top fix for toilet seat Java 1108F

Art. / Item	Descrizione / Models	EAN
1545NTF	Set cerniere take-off, top fix <i>Set hinges take-off and top fix</i>	8029954093564

Ricambi per sedili wc Spare parts for toilet seats



Kit viti e galletti fissaggio rapido per sedili / "Quick fix" fixing kit for toilet seats:
Boxer 1104, K2 Evo 1109, K2 Classic 1107, Atlantic 1100, Z3 1105, Baby 1103

Art. / Item	Descrizione / Models	EAN
1545QF	Kit viti e galletti <i>Fixing kit</i>	8029954000647



Set cerniere take-off per sedile Creta 1108E
Set hinges take-off for toilet seat Creta 1108E

Art. / Item	Descrizione / Models	EAN
1545S	Set cerniere take-off <i>Set hinges take-off</i>	8029954012527



Confezione paracolpi per sedile K2 Classic 1107
Set of buffers for toilet seat K2 Classic 1107

Art. / Item	Descrizione / Models	EAN
1546	Set paracolpi <i>Set buffers</i>	8029954004522



Confezione paracolpi per sedili Boxer 1104, 1104X, K2 Evo 1109, 1109X, Baby 1103
Set of buffers for toilet seats: Boxer 1104, 1104X, K2 Evo 1109, 1109X, Baby 1103

Art. / Item	Descrizione / Models	EAN
1546B	Set paracolpi <i>Set buffers</i>	8029954004621

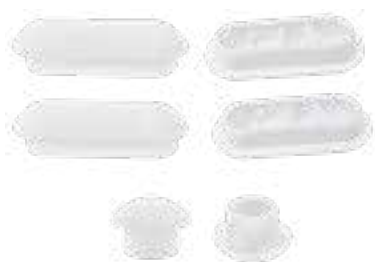

Confezione paracolpi per sedile Creta 1108E
Set of buffers for toilet seat Creta 1108E

Art. / Item	Descrizione / Models	EAN
1546E	Set paracolpi Set buffers	8029954004546



Confezione paracolpi per sedile Java 1108F
Set of buffers for toilet seat Java 1108F

Art. / Item	Descrizione / Models	EAN
1546F	Set paracolpi Set buffers	8029954008179



Confezione paracolpi per sedile Malaga 1108G
Set of buffers for toilet seat Malaga 1108G

Art. / Item	Descrizione / Models	EAN
1546G	Set paracolpi Set buffers	8029954008162



Confezione paracolpi per sedile Everest soft close 1108SC
Set of buffers for toilet seat Everest soft close 1108SC

Art. / Item	Descrizione / Models	EAN
1546SC	Set paracolpi Set buffers	8029954008155



Kit viti e galletti per sedili / Fixing kit for toilet seats:
Boxer 1104, K2 Evo 1109, K2 Classic 1107, Atlantic 1100, Z3 1105, Baby 1103

Art. / Item	Descrizione / Models	EAN
1549	Kit viti e galletti Fixing kit	8029954004577

LEGENDA



Materiale: polipropilene
Material: polypropylene



Adatto ad uso esterno
Suitable for external use



Materiale resistente agli acidi
Acid-resistant material



Realizzato in materiale idoneo per gli alimenti
Suitable for contact with food



Materiale anti-uv
Anti-uv rays plastic



Totalmente lavabile
Easy to clean



Sporgenza al muro di soli 34 cm
Projection from wall 34 cm



Accessoriato con kit di scarico
Equipped with kit siphon+drain



Kit di fissaggio resistente
Strong fixing kit



Imballaggio singolo salvaspazio, impilabile
Smart packaging, space-saver and stackable

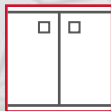

Chiusura a due ante
Two doors closing

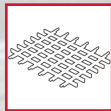

Griglia ordinabile separatamente
Grid sold separately

PILOZZI UTILITY SINKS

La linea dei pilozzi CR: praticità, solidità e design
alla ricerca delle tue comodità

*The line of pilozzi CR: practicality, solidity and design
in search of your comfort*



YOUR SMART SOLUTION



LINEA PILOZZI

Adatta alla tua lavanderia, al tuo giardino o al tuo garage, la linea pilozzi coniuga comodità e cura del dettaglio per soddisfare ogni tua esigenza



Materiale vasca:
polipropilene lucido
sia internamente che
esternamente

Basin material:
Entirely made of
polished polypropylene



Ideale per gli esterni:
resistente agli agenti
atmosferici

Suitable for external use:
weather resistant



Resistenti agli acidi e
agli aggressori chimici

Acid resistant



Realizzato in materiale
idoneo per gli alimenti

Suitable for contact with
food



Materiale anti-uv:
non scolora nel tempo

Anti-uv rays plastic
material: colour stable
during the time



Pilozzo 50

- Dimensioni pilozzo: 50 x 34 x h 21 cm
- Capacità 13,5 litri
- Ripiano portasapone con predisposizione fori per rubinetto e dosatore sapone
- Pilozzo dimensions: 50 x 34 x h 21 cm
- Capacity 13,5 liters
- Shelf with two pre-cut holes for faucet and soap dispenser installation



Pilozzo 55

- Dimensioni pilozzo: 55 x 34 x h 21 cm
- Capacità 18 litri
- Maxi vasca con ampia capacità
- Abbinabile a mobiletto Micro (pag. 192)
- Pilozzo dimensions: 55 x 34 x h 21 cm
- Capacity 13,5 liters
- Maxi basin with wide capacity
- Matching with cabinet Micro (pag. 192)

Colore / Colour	Art. / Item	EAN
	2051	8029954005970
	2051G	8029954008650
	2051M	8029954008698

Colore / Colour	Art. / Item	EAN
	2051A	8029954000722
	2051AG	8029954008667
	2051AM	8029954008704

Info packing

Peso pezzo singolo Weight single piece	PILOZZO 50	2,20	N° scatole singole su pallet N° single box on a pallet	PILOZZO 50	80	Dimensioni pallet Pallet dimensions	PILOZZO 50	80x120x225			
		PILOZZO 55		2,70			PILOZZO 55	80		PILOZZO 55	80x120x225
		PILOZZO 60		2,84			PILOZZO 60	80		PILOZZO 60	80x120x225

Suitable for your laundry, your garden or your garage,
Pilozzi line combines comfort and care of detail to satisfy your every need



Totalmente lavabile
Easy to clean



Sporgenza al muro di soli 34 cm per ottimizzare gli spazi
Projection from wall 34 cm to optimize space



Completo di sifone e piletta con tappo e troppopieno
Complete with siphon and drain with plug and overflow



Kit di fissaggio con viti di alta qualità a testa esagonale, coprivite e doppia staffa
Fixing kit with high quality screws and double fixing bracket



Imballaggio singolo salvaspazio, impilabile
Smart packaging, space-saver and stackable





Pilozzo 60

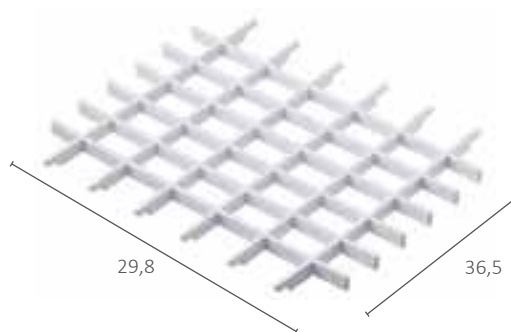

- Dimensioni pilozzo: 59 x 34 x h 21 cm
- Capacità 17 litri
- Ripiano portasapone con predisposizione fori per rubinetto e dosatore sapone
- *Pilozzo dimensions: 59 x 34 x h 21 cm*
- *Capacity 17 liters*
- *Shelf with two pre-cut holes for faucet and soap dispenser installation*





Griglia Pilozzo

- Dimensioni griglia: 36,5 x 29,8 x h 1,6 cm
- Griglia multiuso compatibile con le tre misure di pilozzo
- *Grid dimensions: 36,5 x 29,8 x h 1,6 cm*
- *Multipurpose grid suitable to the three sizes of Pilozzo*

Colore / Colour	Art. / Item	EAN
	2051B	8029954005949
	2051BG	8029954008674
	2051BM	8029954008711

Colore / Colour	Art. / Item	EAN
	2052	8029954005987
	2052G	8029954008681
	2052M	8029954008728

Info packing

 Peso pezzo singolo <i>Weight single piece</i>	GRIGLIA PILOZZO	0,30	 N° pezzi singoli in cartone master <i>N° single pieces in a master box</i>	GRIGLIA PILOZZO	34	 Dimensioni cartone master <i>Master box dimensions</i>	GRIGLIA PILOZZO	60x40x30
--	-----------------	------	---	-----------------	----	--	-----------------	----------

Finiture - Colour finishes

Bianco - White



Mineral



Marmo - Marble





- Griglietta del troppopieno tonda bianca
- Griglia della piletta e coprivite bianchi
- *White overflow grid*
- *White drain grid and screw-covers*



- Griglietta del troppopieno tonda mineral
- Griglia della piletta e coprivite mineral
- *Mineral overflow grid*
- *Mineral drain grid and screw-covers*



- Griglietta del troppopieno tonda in acciaio inox
- Griglia della piletta in acciaio inox
- Viti a vista
- *Stainless steel overflow grid*
- *Stainless steel drain grid*
- *Visible screws*



MICRO

Mobile per pilozzo 55 - Furniture for pilozzo 55



Materiale mobile:
PVC
Furniture material:
PVC



Ideale per gli esterni:
resistente agli agenti
atmosferici
*Suitable for external
use: weather
resistant*



Sporgenza al muro di
soli 34 cm per
ottimizzare gli spazi
*Projection from wall
34 cm to optimize
space*

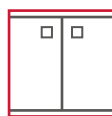

Chiusura con
due ante
Two doors closing

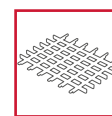

Griglia ordinabile
separatamente
*Grid sold
separately*



Materiale vasca:
polipropilene lucido
sia internamente che
esternamente
*Basin material:
Entirely made of
polished polypropylene*



Art. 5000PK

Art. 2051A

Art. 5000PKC



Art. / Item

EAN

KIT	5000PK	8029954012510
------------	--------	---------------

Art. / Item

EAN

KIT	5000PKC	8029954012503
------------	---------	---------------

Info packing

Dimensioni prodotto singolo <i>Single product dimensions</i>	5000PK	80x29,5x12	Peso pezzo singolo <i>Weight single piece</i>	5000PK	4,00	N° scatole singole su pallet <i>N° single box on a pallet</i>	5000PK	72	Dimensioni pallet <i>Pallet dimensions</i>	5000PK	80x120x231
	5000PKC	80x29,5x47,5		5000PKC	7,50		5000PKC	16		5000PKC	80x120x205

Kit scarico pilozzi

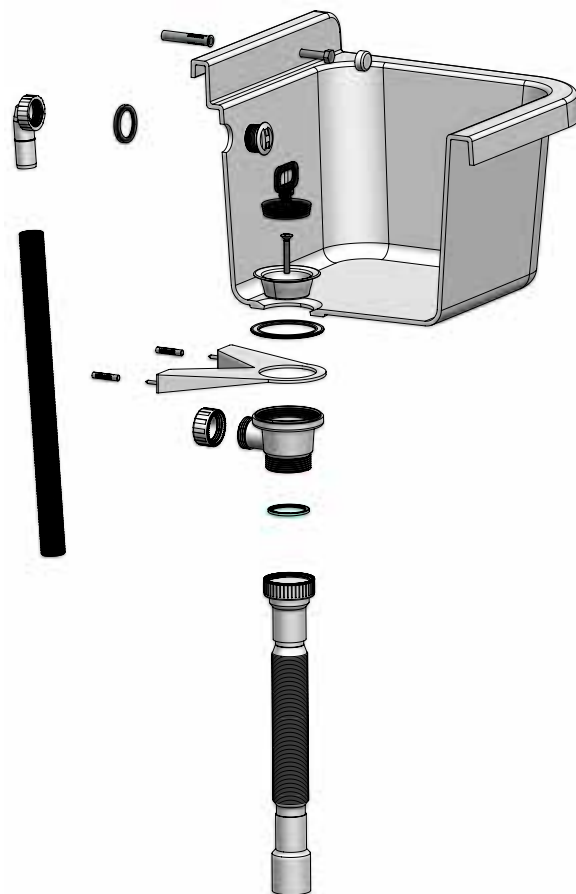

Kit completo di tubo estensibile-comprimibile, staffa, fissaggi e piletta con dettagli **bianchi**

*Kit complete with extensible-flexible pipe, bracket, fixings and drain with **white** details*

Art. / Item		EAN
8058LB	55	8029954040759

Kit completo di tubo estensibile-comprimibile, staffa, fissaggi e piletta con dettagli **mineral**

*Kit complete with extensible-flexible pipe, bracket, fixings and drain with **mineral** details*

Art. / Item		EAN
8058LG	55	8029954040841

Kit completo di tubo estensibile-comprimibile, staffa, fissaggi e piletta con dettagli in **acciaio inox**

*Kit complete with extensible-flexible pipe, bracket, fixings and drain with **stainless steel** details*

Art. / Item		EAN
8058LX	55	8029954040858

LEGENDA



Adatto ad uso interno
Suitable for internal use



Adatto ad uso esterno
Suitable for external use



Chiusura con anta scorrevole
Sliding door closing



Chiusura a due ante
Two doors closing

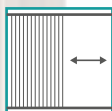

Chiusura con serrandina scorrevole
Sliding door closing



Accessoriato con asse di lavaggio
Equipped with washing board



Accessoriato con cestone multi-uso
Equipped with multipurpose hamper



Accessoriato con kit di scarico
Equipped with kit siphon+drain



Materiale: PVC
Material: PVC



Materiale resistente agli acidi
Acid-resistant material

LAVANDERIA PER INTERNI INTERNAL LAUNDRY

Classe, eleganza e ricerca del dettaglio si intrecciano nell'ampia gamma di AMPHORA, la nuova linea lavanderia pensata e realizzata per soddisfare le tue necessità

Class, elegance and detail research come together in the wide range of AMPHORA, the new laundry line, thought and designed to meet your needs

AMPHORA

Linea Lavanderia

CR presenta AMPHORA, la nuova linea di mobilio per lavanderia. Ampia scelta di finiture moderne come Legno Naturale e Corten Rosso, componenti ricercati e funzionali quali cerniere a chiusura rallentata, ripiani idrorepellenti e accessori di qualità in acciaio INOX, impreziosiscono il tuo bagno che, oltre alla praticità di utilizzo, si arricchisce di eleganza, modernità e attenzione per il design Made in Italy.

CR presents AMPHORA, the new laundry furniture line. Wide selection of modern finishes such as Natural Wood and Red Corten, sophisticated and functional components such as soft-closing hinges, water-proof trays and quality stainless steel accessories, enhance your bathroom that, in addition to the practicality of use, is enriched with elegance, modernity and attention to Made in Italy design.



CR[®]
YOUR SMART
SOLUTION

Pangea



Mobile: Bilaminato
Maniglia: Nichel spazzolato lucido
Vasca: Materiale plastico, forabile per installazione rubinetto
Sportello: Scorrevole, con angoli arrotondati
Asse: Pino verniciato
Scarico: Sifone autopulente con attacco lavatrice, piletta, tappo, troppopieno e particolari inox
Piedini: Regolabili in altezza, 15 mm

Furniture: Bilaminated wood
Handle: Brushed polished nickel
Basin: Plastic material, it can be punched to install the faucet
Door: Sliding, with rounded angles
Washing board: Varnished pine wood
Drain: Self-cleaning siphon with washing-machine coupling, drain, plug and overflow with stainless steel details
Feet: Adjustable height, 15 mm

Finiture colori disponibili - Available colour finishes

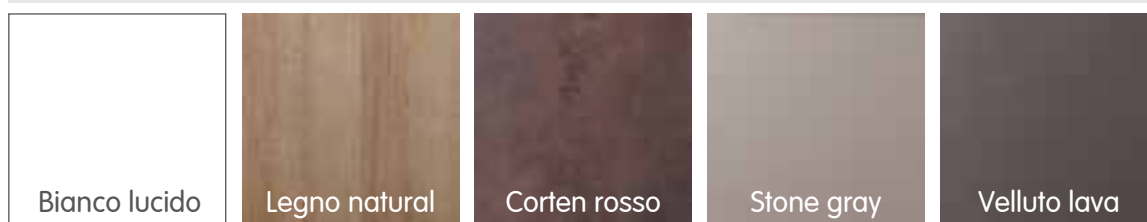

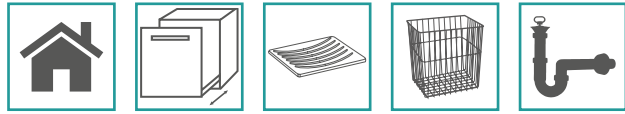

Anta scorrevole con
cestone multi-uso
*Sliding door with
multipurpose hamper*



Vassoio salvafondo in alluminio
Aluminium drip-saving lower tray

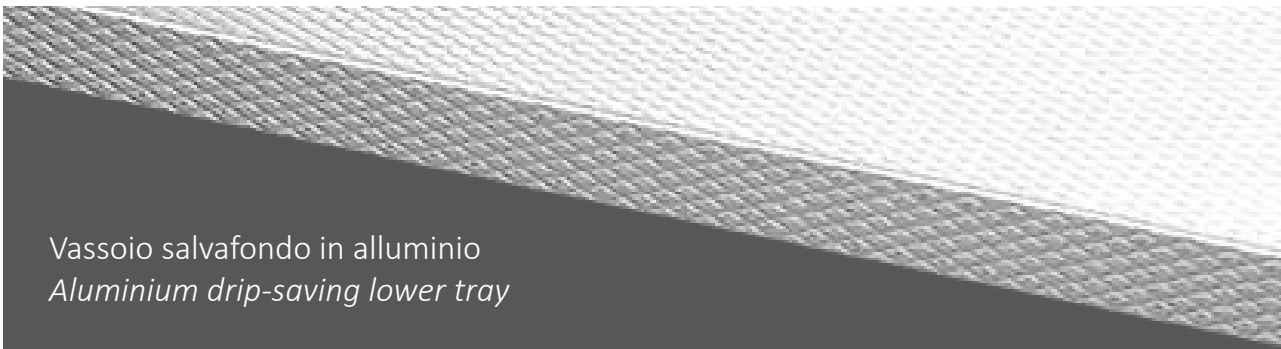

Dettagli piletta inox
Stainless steel details



Pangea



Col.	Art.	EAN
	2006A	8029954013159
	2006ALE	8029954013166
	2006ACR	8029954013173
	2006ASG	8029954013180
	2006AVL	8029954013197

Completi di doppio fondo per alloggiamento asse
Complete with double bottom for washing boarding



Col.	Art.	EAN
	2005A	8029954013203
	2005ALE	8029954013210
	2005ACR	8029954013227
	2005ASG	8029954013234
	2005AVL	8029954013241

Completi di doppio fondo per alloggiamento asse
Complete with double bottom for washing boarding



Col.	Art.	EAN
	2002A	8029954013258
	2002ALE	8029954013265
	2002ACR	8029954013272
	2002ASG	8029954013289
	2002AVL	8029954013296

Completi di doppio fondo per alloggiamento asse
Complete with double bottom for washing boarding



Col.	Art.	EAN
	2007A	8029954013302
	2007ALE	8029954013319
	2007ACR	8029954013326
	2007ASG	8029954013333
	2007AVL	8029954013340

Completi di doppio fondo per alloggiamento asse
Complete with double bottom for washing boarding



Col.	Art.	EAN
	2008ADX	8029954013357
	2008ALEDX	8029954013364
	2008ACRDX	8029954013371
	2008ASGDX	8029954013388
	2008AVLDX	8029954013395

Col.	Art.	EAN
	2008ASX	8029954013401
	2008ALESX	8029954013418
	2008ACRSX	8029954013425
	2008ASGSX	8029954013432
	2008AVLSX	8029954013449

Completi di doppio fondo per alloggiamento asse
Complete with double bottom for washing boarding

Completi di doppio fondo per alloggiamento asse
Complete with double bottom for washing boarding



Col.	Art.	EAN
	2800ADX	8029954013456
	2800ALEDX	8029954013463
	2800ACRDX	8029954013470
	2800ASGDX	8029954013487
	2800AVLDX	8029954013494

Col.	Art.	EAN
	2800ASX	8029954013500
	2800ALESX	8029954013517
	2800ACRSX	8029954013524
	2800ASGSX	8029954013531
	2800AVLSX	8029954013548

Completi di doppio fondo per alloggiamento asse
Complete with double bottom for washing boarding

Completi di doppio fondo per alloggiamento asse
Complete with double bottom for washing boarding



Futura



Mobile: Bilaminato

Maniglie: Nichel spazzolato lucido

Vasca: Materiale plastico, forabile per installazione rubinetto

Sportelli: Con angoli arrotondati

Asse: Pino verniciato

Scarico: Sifone autopulente con attacco lavatrice, piletta, tappo, troppopieno e particolari inox

Piedini: Regolabili in altezza, 15 mm

Zoccolo estraibile per una facile pulizia: In PVC, ricoperto con lamina in alluminio

Furniture: Bilaminated wood

Handles: Brushed polished nickel

Basin: Plastic material, it can be punched to install the faucet

Doors: With rounded angles

Washing board: Varnished pine wood

Drain: Self-cleaning siphon with washing-machine coupling, drain, plug and overflow with stainless steel details

Feet: Adjustable height, 15 mm

Removable base for an easier cleaning: Made of PVC, with aluminum laminated finish



Finiture colori disponibili - Available colour finishes

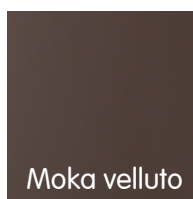
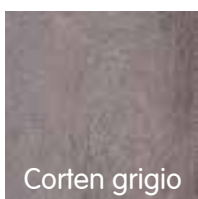
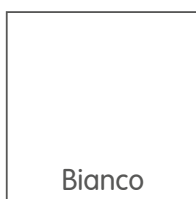

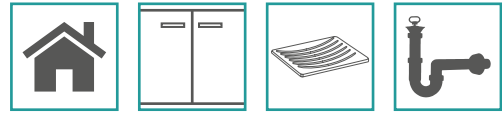

Cerniere a chiusura
rallentata
*Hinges with
soft closing*



Pianale salvafondo in alluminio
Aluminum lower tray



Dettagli piletta inox
Stainless steel details



Futura



Col.	Art.	EAN	Col.	Art.	EAN	Col.	Art.	EAN
	2006FB	8029954013555		2005FB	8029954013586		2003FB	8029954013616
	2006FCG	8029954013562		2005FCG	8029954013593		2003FCG	8029954013623
	2006FMV	8029954013579		2005FMV	8029954013609		2003FMV	8029954013630



Col.	Art.	EAN	Col.	Art.	EAN	Col.	Art.	EAN
	2009FB	8029954013647		2002FB	8029954013678		2007FB	8029954013708
	2009FCG	8029954013654		2002FCG	8029954013685		2007FCG	8029954013715
	2009FMV	8029954013661		2002FMV	8029954013692		2007FMV	8029954013722



Col.	Art.	EAN
	2013FB	8029954013739
	2013FCG	8029954013746
	2013FMV	8029954013753

Col.	Art.	EAN
	2012FB	8029954013760
	2012FCG	8029954013777
	2012FMV	8029954013784



Vasca con discescina
Basin with inclined washing surface

Asse di lavaggio in legno a richiesta
Wooden washing board on request

Col.	Art.	EAN
	2001FB	8029954013791



Tutta vasca
One basin

Col.	Art.	EAN
	2010FB	8029954013807



Col.	Art.	EAN
	2008FBDX	8029954013814
	2008FCGDX	8029954013821
	2008FMVDX	8029954013838

Completi di doppiofondo per alloggiamento asse
Complete with double bottom for washing boarding



Col.	Art.	EAN
	2008FBSX	8029954013845
	2008FCGSX	8029954013852
	2008FMVSX	8029954013869

Completi di doppiofondo per alloggiamento asse
Complete with double bottom for washing boarding



Col.	Art.	EAN
	2800FBDX	8029954013876
	2800FCGDX	8029954013883
	2800FMVDX	8029954013890

Completi di doppiofondo per alloggiamento asse
Complete with double bottom for washing boarding



Col.	Art.	EAN
	2800FBSX	8029954013906
	2800FCGSX	8029954013913
	2800FMVSX	8029954013920

Completi di doppiofondo per alloggiamento asse
Complete with double bottom for washing boarding



Queen



Mobile: Bilaminato
Maniglie: Satinate
Vasca: Ceramica, con foro per installazione rubinetto
Sportelli: Con angoli squadrati
Scarico: Sifone autopulente completo di pilettoni 3"1/2 con accessori in acciaio inox e tappo copri foro vasca
Piedini: Regolabili in altezza, 15 mm

Furniture: Bilaminated wood
Handles: Satin
Basin: Ceramic sink, with hole for faucet installation
Doors: With rounded angles
Drain: Self-cleaning siphon, 3"1/2 drain with stainless steel details and cover-plug for faucet-hole
Feet: Adjustable height, 15 mm

Completo di doppiofondo per alloggiamento asse
 Complete with double bottom for washing boarding

Art.	Min. quant.	EAN
2002BCER	4	8029954005314



Accessori a richiesta - Accessories on request

Portasapone per vasca in ceramica
 Soap dish for ceramic sink

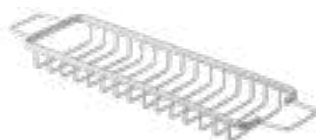

Art.	EAN
PORTASAPK	8029954003198

Asse in pino verniciato per vasca in ceramica
 Washing board made of varnished pine wood for ceramic sink



Art.	EAN
2042K	8029954059379



Vasca in ceramica di grandi dimensioni
Large ceramic basin

Dimensioni interne / Internal dimensions: 46 x 42 x 26 cm

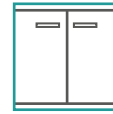

Vasca in ceramica
con pilettone e
dettagli inox
*Ceramic sink with
drain 3"1/2 and
stainless steel details*



Cerniere ante a
chiusura rallentata
*Door's hinges with
soft closing*



Pianale salvafondo in alluminio
Aluminum lower tray

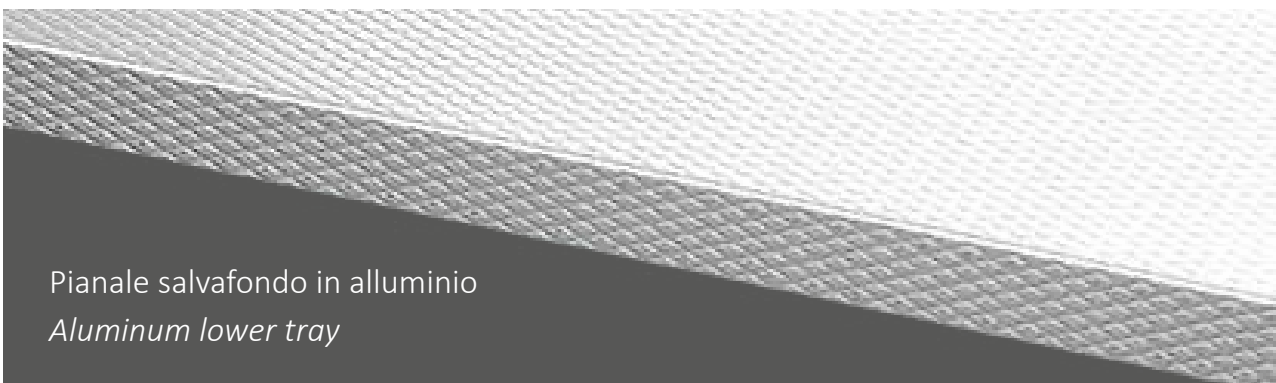

Tappo copriforo rivestito in acciaio inox
Cover plug for hole coated with stainless steel



Ontario

Mobile: Bilaminato con finitura olmo

Maniglie e piedini: Finitura satinata brunita

Vasca: Materiale plastico, forabile per installazione rubinetto

Sportelli: Con angoli squadrate

Asse: Materiale plastico

Scarico: Sifone autopulente con attacco lavatrice, piletta, tappo e troppopieno

Furniture: Bilaminated wood with elm finish

Handles and feet: Satin-brunite finish

Basin: Plastic material, it can be punched to install the faucet

Doors: With squared angles

Washing board: Plastic material

Drain: Self-cleaning siphon with washing machine coupling, drain, plug and overflow

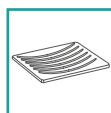
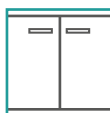

Maniglie finitura satinata brunita

Handles with satin-brunited finish



Piedini satinati bruniti a spigolo vivo

Square-edged feet with satin-brunited finish



Finitura olmo - Elm finish



Ontario



Col.	Art.	EAN	Col.	Art.	EAN	Col.	Art.	EAN
	3006SO	8029954013937		3005SO	8029954013944		3003SO	8029954013951



Col.	Art.	EAN
	3002SO	8029954013968

Col.	Art.	EAN
	3007SO	8029954013975



Col.	Art.	EAN
	3013SO	8029954013982

Col.	Art.	EAN
	3012SO	8029954013999



Vasca con discesina
*Basin with inclined
washing surface*
Asse di lavaggio in
legno a richiesta
*Wooden washing
board on request*

Col.	Art.	EAN
	3001SO	8029954014002



Tutta vasca
One basin

Col.	Art.	EAN
	3010SO	8029954014019



Col.	Art.	EAN
	3008SODX	8029954014026



Col.	Art.	EAN
	3008SOSX	8029954014033



Col.	Art.	EAN
	3800SODX	8029954014040



Col.	Art.	EAN
	3800SOSX	8029954014057



Pratika

Mobile: Bilaminato

Maniglie e piedini: Finitura satinata

Vasca: Materiale plastico, forabile per installazione rubinetto

Sportelli: Con angoli squadrati

Asse: Materiale plastico

Scarico: Sifone autopulente con attacco lavatrice, piletta, tappo e troppopieno

Furniture: Bilaminated wood

Handles and feet: Satin finish

Basin: Plastic material, it can be punched to install the faucet

Doors: With squared angles

Washing board: Plastic material

Drain: Self-cleaning siphon with washing machine coupling, drain, plug and overflow

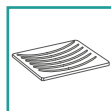
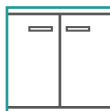

Maniglie finitura satinata
Handles with satin finish



Piedini satinati a spigolo vivo
Square-edged feet with satin finish

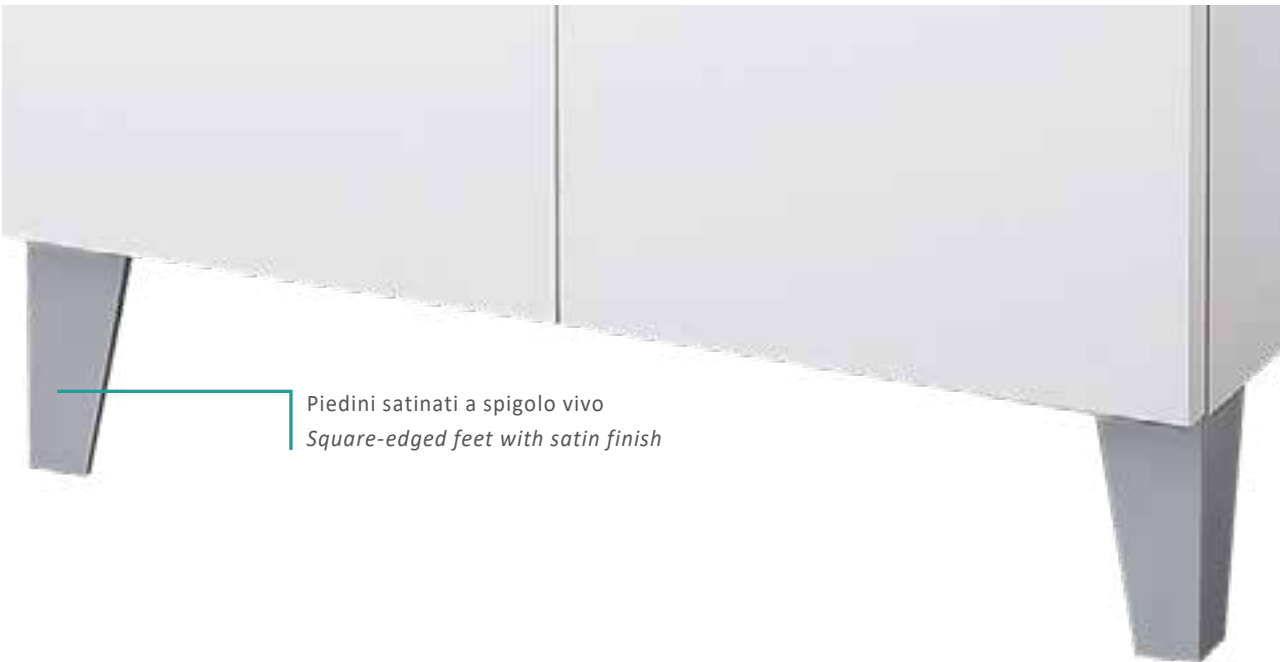

Finitura bianco opaco - White finish



Pratika



Col.	Art.	EAN
<input type="checkbox"/>	3006SB	8029954014064



Col.	Art.	EAN
<input type="checkbox"/>	3005SB	8029954014071



Col.	Art.	EAN
<input type="checkbox"/>	3003SB	8029954014088



Col.	Art.	EAN
<input type="checkbox"/>	3009SB	8029954014095



Col.	Art.	EAN
<input type="checkbox"/>	3002SB	8029954014101



Col.	Art.	EAN
<input type="checkbox"/>	3007SB	8029954014118

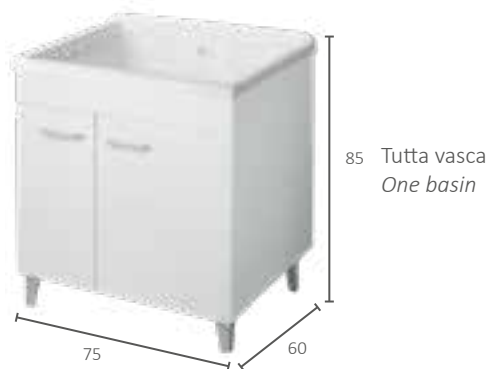

Col.	Art.	EAN
<input type="checkbox"/>	3013SB	8029954014125



Col.	Art.	EAN
<input type="checkbox"/>	3012SB	8029954014132

Pratika



Vasca con discesina
*Basin with inclined
 washing surface*
 Asse di lavaggio in
 legno a richiesta
*Wooden washing
 board on request*

Col.	Art.	EAN
<input type="checkbox"/>	3001SB	8029954014149



Tutta vasca
One basin

Col.	Art.	EAN
<input type="checkbox"/>	3010SB	8029954014156



Col.	Art.	EAN
<input type="checkbox"/>	3008SBDX	8029954014163



Col.	Art.	EAN
<input type="checkbox"/>	3008SBSX	8029954014170



Col.	Art.	EAN
<input type="checkbox"/>	3800SBDX	8029954014187



Col.	Art.	EAN
<input type="checkbox"/>	3800SBSX	8029954014194



Basic

Mobile: Bilaminato

Maniglie: Bianche

Vasca: Materiale plastico, forabile per installazione rubinetto

Sportelli: Con angoli squadri

Asse: Materiale plastico

Scarico: Sifone autopulente con attacco lavatrice, piletta, tappo e troppopieno

Furniture: Bilaminated wood

Handles: White

Basin: Plastic material, it can be punched to install the faucet

Doors: With squared angles

Washing board: Plastic material

Drain: Self-cleaning siphon with washing machine coupling, drain, plug and overflow

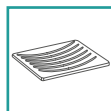
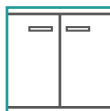



Col.	Art.	EAN
	7006	8029954006656



Col.	Art.	EAN
	7003	8029954007516



Col.	Art.	EAN
	7002	8029954006663



Col.	Art.	EAN
	7007	8029954006670



Rocky

Mobile: Bilaminato

Maniglie e piedini: Satinati

Vasca: Materiale plastico, forabile per installazione rubinetto

Sportelli: Con angoli squadri

Asse: Materiale plastico

Scarico: Sifone autopulente con attacco lavatrice, piletta, tappo e troppopieno

Furniture: Bilaminated wood

Handles and feet: Satin

Basin: Plastic material, it can be punched to install the faucet

Doors: With squared angles

Washing board: Plastic material

Drain: Self-cleaning siphon with washing machine coupling, drain, plug and overflow

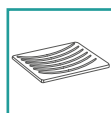
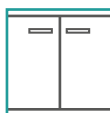



Col.	Art.	EAN
	6006SK	8029954008490



Col.	Art.	EAN
	6003SK	8029954008773



Col.	Art.	EAN
	6002SK	8029954008506



Col.	Art.	EAN
	6007SK	8029954008513



LEGENDA



Adatto ad uso esterno
Suitable for external use



Chiusura con anta scorrevole
Sliding door closing



Chiusura a due ante
Two doors closing

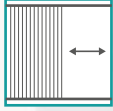

Chiusura con serrandina scorrevole
Sliding door closing

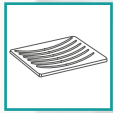

Accessoriato con asse di lavaggio
Equipped with washing board



Accessoriato con cestone multi-uso
Equipped with multipurpose hamper



Accessoriato con kit di scarico
Equipped with kit siphon+drain



Materiale: PVC
Material: PVC



Materiale resistente agli acidi
Acid-resistant material

LAVANDERIA PER ESTERNI EXTERNAL LAUNDRY

La libertà di progettare i tuoi spazi supportata dalle nostre valide soluzioni che ti permettono di arredare gli esterni della tua casa

The freedom to design your place supported by our valid solutions that allow you to furnish the open spaces of your home

AMPHORA

Linea Lavanderia



CR[®]

YOUR SMART
SOLUTION

Kubo

Mobile: Materiale plastico resistente all'acqua

Maniglie e piedini: Cromati

Vasca: Materiale plastico, forabile per installazione rubinetto

Asse: Materiale plastico

Scarico: Sifone autopulente con attacco lavatrice, piletta, tappo e troppopieno

Piedini: Regolabili in altezza, 15 mm

Furniture: Plastic water-proof material

Handles and feet: Chromed

Basin: Plastic material, it can be punched to install the faucet

Washing board: Plastic material

Drain: Self-cleaning siphon with washing machine coupling, drain, plug and overflow

Feet: Adjustable height, 15 mm

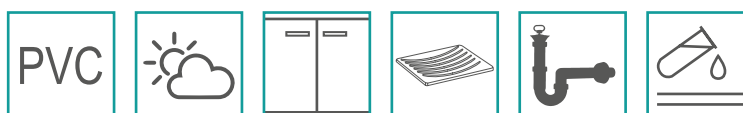



Col.	Art.	EAN
	9046	8029954102730



Col.	Art.	EAN
	9043	8029954103188



Col.	Art.	EAN
	9042	8029954102723



Col.	Art.	EAN
	9047	8029954103058



Junior

Mobile: Materiale plastico resistente all'acqua

Maniglie: Cromate

Vasca: Materiale plastico, forabile per installazione rubinetto

Asse: Materiale plastico

Scarico: Sifone autopulente con attacco lavatrice, piletta, tappo e troppopieno

Piedini: Regolabili in altezza, 15 mm

Furniture: Plastic water-proof material

Handles: Chromed

Basin: Plastic material, it can be punched to install the faucet

Washing board: Plastic material

Drain: Self-cleaning siphon with washing machine coupling, drain, plug and overflow

Feet: Adjustable height, 15 mm

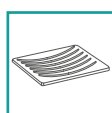



Finiture colori disponibili - Available colour finishes



Junior



Col.	Art.	EAN	Col.	Art.	EAN	Col.	Art.	EAN
	9006	8029954006687		9003	8029954007486		9007	8029954006700
KIT	9006K	8029954007189	KIT	9003K	8029954007226	KIT	9007K	8029954007202



Col.	Art.	EAN
	9002	8029954006694
	9002R	8029954057337
	9002F	8029954103225
	9002W	8029954103218

Col.	Art.	EAN
KIT	9002K	8029954007196
KIT	9002KR	8029954057320
KIT	9002KF	8029954007233
KIT	9002KW	8029954007240

KIT AUTOMONTANTE - SELF-ASSEMBLING KIT

Art. 9006K - 9003K - 9002K



Montaggio veloce
senza l'ausilio di
attrezzi

Fast mounting
without tools



Montaggio semplice e veloce
Easy and fast mounting



Adatto a luoghi esterni ed interni
Suitable for indoor and outdoor



Istruzioni di montaggio
Mounting instructions



Vasca con discesa
Basin with inclined washing surface
 Asse di lavaggio a richiesta
Washing board on request



Tutta vasca
One basin

Col.	Art.	EAN
<input type="checkbox"/>	9001	8029954014200

Col.	Art.	EAN
<input type="checkbox"/>	9010	8029954014217



Col.	Art.	EAN
<input type="checkbox"/>	9008DX	8029954007066
<input type="checkbox"/>	KIT 9008K	8029954012701

Col.	Art.	EAN
<input type="checkbox"/>	9008SX	8029954007059
<input type="checkbox"/>	KIT 9008K	8029954012701



Col.	Art.	EAN
<input type="checkbox"/>	9800DX	8029954007080

Col.	Art.	EAN
<input type="checkbox"/>	9800SX	8029954007073



Pensili

Pensile: Materiale plastico resistente all'acqua

Maniglie: Cromate

Dimensioni: 59 x 21 x 59 cm

Cabinet: Plastic water-proof material

Handles: Chromed

Dimensions: 59 x 21 x 59 cm





Rovere



Frassino



Wengè

	Col.	Art.	EAN
KIT		F760PR	8029954094301
KIT		F760PF	8029954094288
KIT		F760PW	8029954094295



Bianco

Col.	Art.	EAN
KIT	F760P	8029954094271

Finiture colori disponibili - Available colour finishes

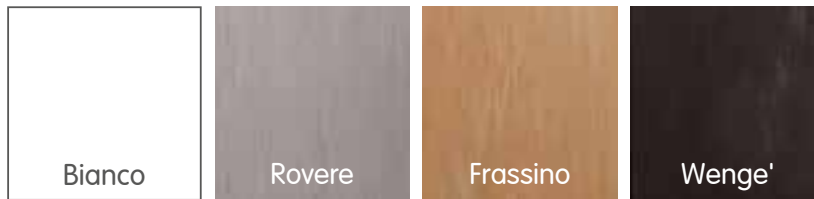

Simpaty



Mobiletto per bagno con specchio, due antine, predisposizione luce e interruttore.

Dimensioni: 58x37x12 cm

Plastic cabinet with mirror, two doors, predisposition for light bulb and switch.

Dimensions: 58x37x12 cm

Col.	Art.	EAN
	1150	8029954001460



Compact

Mobile: Materiale plastico resistente all'acqua

Anta: Serrandina

Vasca: Materiale plastico, forabile per installazione rubinetto

Asse: Materiale plastico

Scarico: Sifone autopulente con attacco lavatrice, pileta, tappo e troppopieno

Piedini: Regolabili in altezza, 15 mm

Furniture: Plastic water-proof material

Door: Sliding shutter

Basin: Plastic material, it can be punched to install the faucet

Washing board: Plastic material

Drain: Self-cleaning siphon with washing machine coupling, drain, plug and overflow

Feet: Adjustable height, 15 mm

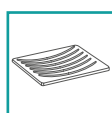
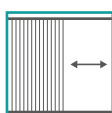

Serrandina salvaspazio - *Space-saving sliding shutter*

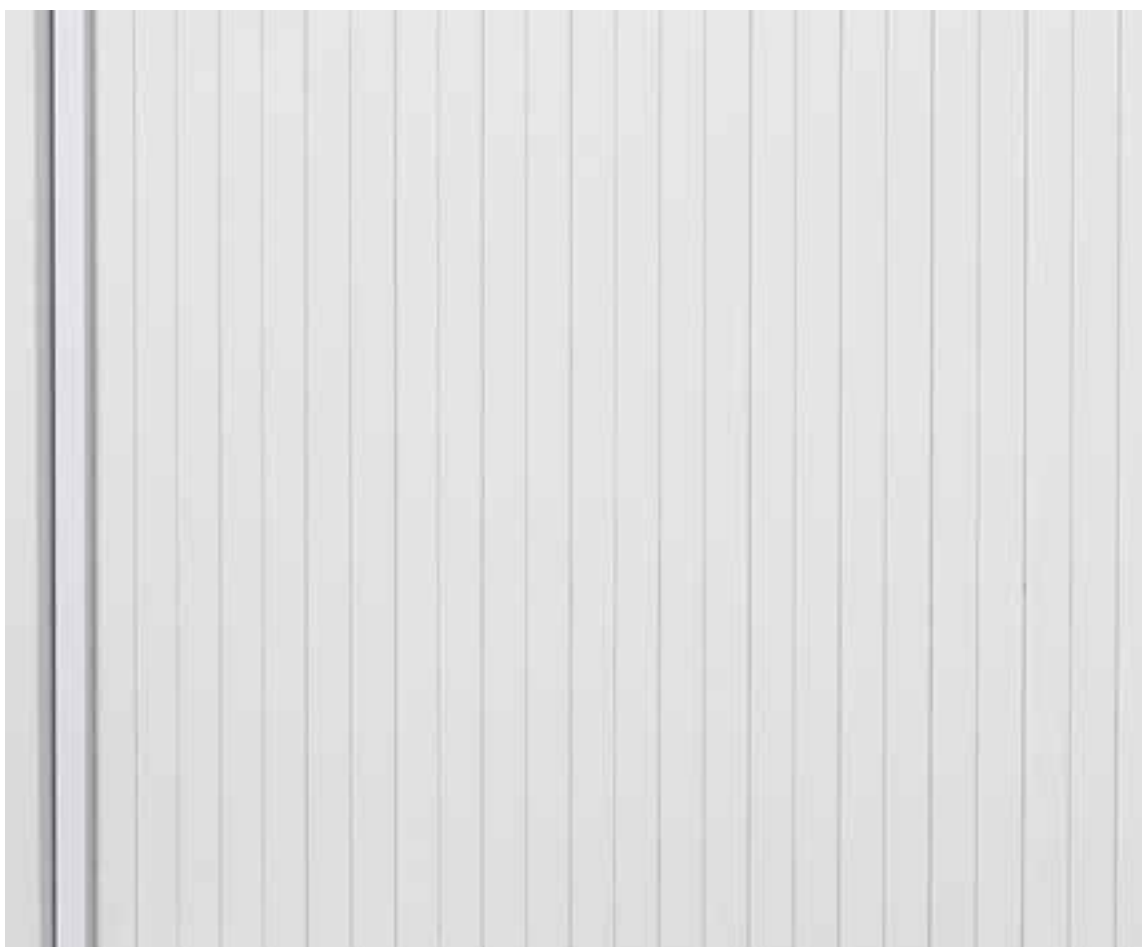

- Non occupa spazi superflui
- Adatto per garage, balconi e piccole lavanderie
- Serrandina funzionale e pratica

- *Compact solution not to waste space*
- *Suitable for garages, balconies and small laundries*
- *Small and practical sliding shutter*



Compact



Col.	Art.	EAN
<input type="checkbox"/>	4006	8029954006540
<input checked="" type="checkbox"/>	4006K	8029954007158

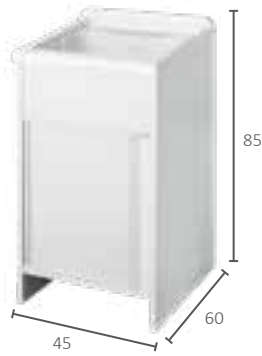

Col.	Art.	EAN
<input type="checkbox"/>	4005	8029954006557
<input checked="" type="checkbox"/>	4005K	8029954007159

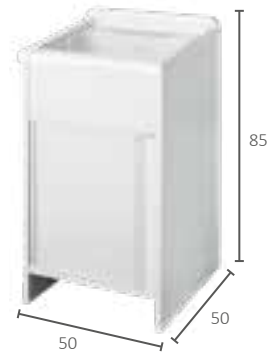

Col.	Art.	EAN
<input type="checkbox"/>	4003	8029954006564
<input checked="" type="checkbox"/>	4003K	8029954007219



Col.	Art.	EAN
<input type="checkbox"/>	4002	8029954006571
<input checked="" type="checkbox"/>	4002K	8029954007165



Col.	Art.	EAN
<input type="checkbox"/>	4007	8029954006588
<input checked="" type="checkbox"/>	4007K	8029954007172



Vasca con discolina
Basin with inclined
washing surface

Col.	Art.	EAN
<input checked="" type="checkbox"/>	4001	8029954006595



Tutta vasca
One basin

Col.	Art.	EAN
<input type="checkbox"/>	4010	8029954006601



Col.	Art.	EAN
	4008DX	8029954006618



Col.	Art.	EAN
	4008SX	8029954006625



Col.	Art.	EAN
	4800DX	8029954006632



Col.	Art.	EAN
	4800SX	8029954006649



MICRO

Lavatoi a profondita' ridotta - *Space-saving furnitures*



Materiale vasca:
polipropilene lucido
sia internamente che
esternamente

*Basin material:
Entirely made of
polished polypropylene*



Materiale mobile:
PVC
*Furniture material:
PVC*



Ideale per esterni:
resistente agli
agenti atmosferici
*Suitable for external
use: weather
resistant*



Sporgenza al muro
di soli 34 cm per
ottimizzare gli spazi
*Projection from wall
34 cm to optimize
space*



Resistente agli acidi
Acid resistant

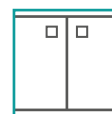

Chiusura con
due ante
Two doors closing

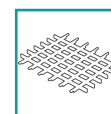

Griglia ordinabile
separatamente
*Grid sold
separately*



Col.	Art.	EAN
	5001PMC	8029954103409
	5000PKC	8029954012503



- Dimensioni griglia: 36,5 x 29,8 x h 1,6 cm
- Griglia multiuso compatibile
- *Grid dimensions: 36,5 x 39,8 x h 1,6 cm*
- *Suitable multipurpose grid*

Col.	Art.	EAN
	2052	8029954005987

Lavatoi a profondita' ridotta - *Space-saving furnitures*



Materiale vasca:
polipropilene lucido
sia internamente che
esternamente

Basin material:
Entirely made of
polished polypropylene



Materiale mobile:
PVC
Furniture material:
PVC



Ideale per esterni:
resistente agli
agenti atmosferici
Suitable for external
use: weather
resistant



Sporgenza al muro
di soli 34 cm per
ottimizzare gli spazi
Projection from wall
34 cm to optimize
space



Resistente agli acidi
Acid resistant

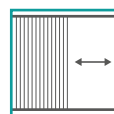

Chiusura con
serrandine
salvaspazio
Space-saving
closing with
sliding doors

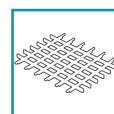

Griglia ordinabile
separatamente
Grid sold
separately



Col.	Art.	EAN
	5000PMC	8029954103164



- Dimensioni griglia: 36,5 x 29,8 x h 1,6 cm
- Griglia multiuso compatibile
- Grid dimensions: 36,5 x 39,8 x h 1,6 cm
- Suitable multipurpose grid

Col.	Art.	EAN
	2052	8029954005987



LEGENDA



Adatto ad uso interno
Suitable for internal use



Adatto ad uso esterno
Suitable for external use



Chiusura con anta scorrevole
Sliding door closing



Chiusura a due ante
Two doors closing

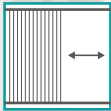

Chiusura con serrandina scorrevole
Sliding door closing

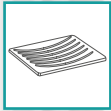

Accessoriato con asse di lavaggio
Equipped with washing board



Accessoriato con cestone multi-uso
Equipped with multipurpose hamper



Accessoriato con kit di scarico
Equipped with kit siphon+drain



Materiale: PVC
Material: PVC



Materiale resistente agli acidi
Acid-resistant material

COPRILAVATRICE WASHING-MACHINE COVER



YOUR SMART
SOLUTION

AMPHORA

Linea Lavanderia



Coprilavatrice

Pangea



Immagine/Image art.2008ALEDX

Col.	Art.	EAN
	2008ADX	8029954013357
	2008ALEDX	8029954013364
	2008ACRDX	8029954013371
	2008ASGDX	8029954013388
	2008AVLDX	8029954013395



Vasca a destra
Basin on the right

Col.	Art.	EAN
	2008ASX	8029954013401
	2008ALESX	8029954013418
	2008ACRSX	8029954013425
	2008ASGSX	8029954013432
	2008AVLSX	8029954013449



Vasca a sinistra
Basin on the left

Completi di doppio fondo per alloggiamento asse
Complete with double bottom for washing boarding



Immagine/Image art.2800ALEDX

Col.	Art.	EAN
	2800ADX	8029954013456
	2800ALEDX	8029954013463
	2800ACRDX	8029954013470
	2800ASGDX	8029954013487
	2800AVLDX	8029954013494



Vasca a destra
Basin on the right

Col.	Art.	EAN
	2800ASX	8029954013500
	2800ALESX	8029954013517
	2800ACRSX	8029954013524
	2800ASGSX	8029954013531
	2800AVLSX	8029954013548



Vasca a sinistra
Basin on the left

Completi di doppio fondo per alloggiamento asse
Complete with double bottom for washing boarding

Futura



Immagine/Image art.2008FCGDX

Col.	Art.	EAN
	2008FBDX	8029954013814
	2008FCGDX	8029954013821
	2008FMVDX	8029954013838

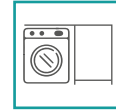

Vasca a destra
Basin on the right

Col.	Art.	EAN
	2008FBSX	8029954013845
	2008FCGSX	8029954013852
	2008FMVSX	8029954013869



Vasca a sinistra
Basin on the left

Completi di doppio fondo per alloggiamento asse
Complete with double bottom for washing boarding



Immagine/Image art.2800FCGDX

Col.	Art.	EAN
	2800FBDX	8029954013876
	2800FCGDX	8029954013883
	2800FMVDX	8029954013890



Vasca a destra
Basin on the right

Col.	Art.	EAN
	2800FBSX	8029954013906
	2800FCGSX	8029954013913
	2800FMVSX	8029954013920

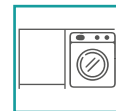

Vasca a sinistra
Basin on the left

Completi di doppio fondo per alloggiamento asse
Complete with double bottom for washing boarding



Coprilavatrice

Ontario



Immagine/Image art.3008SODX

Col.	Art.	EAN
	3008SODX	8029954014026



Vasca a destra
Basin on the right

Col.	Art.	EAN
	3008SOSX	8029954014033



Vasca a sinistra
Basin on the left



Immagine/Image art.3800SODX

Col.	Art.	EAN
	3800SODX	8029954014040

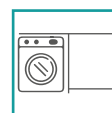

Vasca a destra
Basin on the right

Col.	Art.	EAN
	3800SOSX	8029954014057

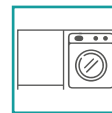

Vasca a sinistra
Basin on the left

Pratika



Immagine/Image art.3008SBDX

Col.	Art.	EAN
	3008SBDX	8029954014163



Vasca a destra
Basin on the right

Col.	Art.	EAN
	3008SBSX	8029954014170



Vasca a sinistra
Basin on the left



Immagine/Image art.3800SBDX

Col.	Art.	EAN
	3800SBDX	8029954014187



Vasca a destra
Basin on the right

Col.	Art.	EAN
	3800SBSX	8029954014194

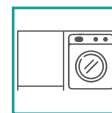

Vasca a sinistra
Basin on the left

Junior



Col.	Art.	EAN
	9008DX	8029954007066
	9008K	8029954012701



Vasca a destra
Basin on the right

Col.	Art.	EAN
	9008SX	8029954007059
	9008K	8029954012701



Vasca a sinistra
Basin on the left



Col.	Art.	EAN
	9800DX	8029954007080

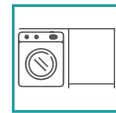

Vasca a destra
Basin on the right

Col.	Art.	EAN
	9800SX	8029954007073

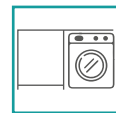

Vasca a sinistra
Basin on the left

Compact



Col.	Art.	EAN
	4008DX	8029954006618



Vasca a destra
Basin on the right

Col.	Art.	EAN
	4008SX	8029954006625



Vasca a sinistra
Basin on the left



Col.	Art.	EAN
	4800DX	8029954006632

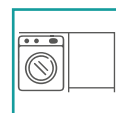

Vasca a destra
Basin on the right

Col.	Art.	EAN
	4800SX	8029954006649

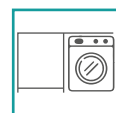

Vasca a sinistra
Basin on the left



Yeti



92,5

**Spazio interno
per lavatrice**
**Internal space available
for washing machine**

Profondità: 53 cm alla base,
56 cm ad altezza oblò
Larghezza: 62 cm
Altezza: 87 cm

*Depth: 53 cm lower base,
56 cm window level
Width: 62 cm
Height: 87 cm*

109

60



Vasca reversibile
Reversible basin

Art.

EAN

KIT 5008P

8029954008582

Mobile: Materiale plastico, resistente all'acqua, con sportelli copri-lavatrice

Maniglie: Cromate

Vasca: Materiale plastico resistente all'acqua, forabile per installazione rubinetto

Asse: Materiale plastico

Scarico: Sifone autopulente con attacco lavatrice, piletta, tappo e troppopieno

Piedini: Regolabili in altezza, 15 mm

Furniture: Plastic water-proof material, with doors that allows to hide the washing machine

Handle: Chromed

Basin: Plastic water-proof material, it can be punched to install the faucet

Washing board: Plastic material

Drain: Self-cleaning siphon with washing machine coupling, equipped of drain, plug and overflow

Feet: Adjustable height, 15 mm



**Spazio interno
per lavatrice**
*Internal space available
for washing machine*

Profondità: 54 cm *Depth: 54 cm*
Larghezza: 63,5 cm *Width: 63,5 cm*
Altezza: 87 cm *Height: 87 cm*



*Cerniere ante a
chiusura rallentata*
*Door's hinges with
soft closing*

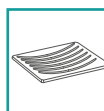

Vasca reversibile
Reversible basin

Art.	EAN
5008A	8029954040865

Mobile: Bilaminato, con sportelli copri-lavatrice

Maniglie: Nichel spazzolato lucido

Vasca: Materiale plastico resistente all'acqua, forabile per installazione rubinetto

Asse: Materiale plastico

Scarico: Sifone autopulente con attacco lavatrice, piletta, tappo e troppopieno

Piedini: Regolabili in altezza, 15 mm

Zoccolino anteriore estraibile: per facilitare la pulizia e l'installazione della lavatrice

Furniture: *Bilaminated material, with doors that allows to hide the washing machine*

Handle: *Brushed polished nickel*

Basin: *Plastic water-proof material, it can be punched to install the faucet*

Washing board: *Plastic material*

Drain: *Self-cleaning siphon with washing-machine coupling, equipped of drain, plug and overflow*

Feet: *Adjustable height, 15 mm*

Removable base: *Make easy the furniture cleaning and the placement of the washing machine*



Igloo



94

60

70

Spazio interno per lavatrice

Internal space available for washing machine

Profondità: 54 cm alla base,
58 cm ad altezza oblò
Larghezza: 64 cm
Altezza: 91 cm

*Depth: 54 cm lower base,
58 cm window level
Width: 64 cm
Height: 91 cm*



Art.	EAN
KIT 5012P	8029954007110

Mobile in materiale plastico resistente all'acqua, con sportelli copri-lavatrice

Piedini regolabili in altezza, 15 mm
Comodo accesso al **filtro** della lavatrice
Completo di **kit di fissaggio** al muro

Washing machine shelter suitable for outdoor use, made of tough plastic water-proof material, with doors that allow to hide the washing-machine
Height of the **feet** 15 mm

Easy access to the **filter** of the washing machine
Complete with **wall fixing kit**

Scudo



Spazio interno per lavatrice
Internal space available for washing machine

Profondità: 58 cm
 Larghezza: 62,5 cm
 Altezza: 91 cm

*Depth: 58 cm
 Width: 62,5 cm
 Height: 91 cm*



Art.	EAN
KIT 5011P	8029954007127

Mobile in materiale plastico resistente all'acqua, con chiusura salvaspazio a serrandina
Piedini regolabili in altezza, 15 mm
 Completo di **kit di fissaggio** al muro

Washing machine shelter suitable for outdoor use, made of tough plastic water-proof material, with sliding shutter
 Height of the **feet** 15 mm
 Complete with **wall fixing kit**



Kasko

EXTRA-LARGE



94

**Spazio interno
per lavatrice**

**Internal space available
for washing machine**

Profondità: 65 cm alla base,
69 cm ad altezza oblò
Larghezza: 68 cm
Altezza: 91 cm

*Depth: 65 cm lower base,
69 cm window level
Width: 68 cm
Height: 91 cm*

71

76,3



Art.	EAN
KIT 5010P	8029954007134

Mobile in materiale plastico resistente all'acqua, con chiusura salvaspazio con due serrandine

Dimensioni maggiorate per contenere lavatrici più profonde

Accesso comodo al **filtro** della lavatrice

Piedini regolabili in altezza, 15 mm

Completo di **kit di fissaggio** al muro

Washing machine shelter suitable for outdoor use, made of tough plastic water-proof material, with two sliding shutters to save space

Extra large sizes to fit bigger washing machines

Easy access to the **filter** of the washing machine

Height of the **feet** 15 mm

Complete with **wall fixing kit**

EXTRA-LARGE



93,5

**Spazio interno
per lavatrice**

**Internal space available
for washing machine**

Profondità: 65 cm alla base,
69 cm ad altezza oblò
Larghezza: 71 cm
Altezza: 90 cm

*Depth: 65 cm lower base,
69 cm window level
Width: 71 cm
Height: 90 cm*

71

76,3



Art.	EAN
KIT 5013P	8029954007257

Mobile in materiale plastico resistente all'acqua, per preservare al meglio lavatrici e asciugatrici di ogni dimensione.

Dimensioni maggiorate per contenere lavatrici più profonde

Comodo accesso al **filtro** della lavatrice

Piedini regolabili in altezza, 15 mm

Completo di **kit di fissaggio** al muro

Washing machine shelter suitable for outdoor use, made of tough plastic water-proof material

Extra large sizes to fit bigger washing machines

Easy access to the **filter** of the washing machine

Height of the **feet** 15 mm

Complete with **wall fixing kit**



Sottoceramica



Col.	Art.	EAN
	2016	8029954102617

Mobiletto per lavatoio di
ceramica in appoggio 60x50 cm
Maniglie e piedini cromati
Compatibile con vasche in ceramica
modello Messico Dolomite*

*Small furniture for fire clay basin 60x50 cm
Chromed handles and chromed feet
Suitable to fire-clay basins,
model Messico Dolomite**



Col.	Art.	EAN
	2017	8029954103911

Mobiletto per lavatoio di
ceramica in appoggio 75x60 cm
Maniglie e piedini cromati
Compatibile con vasche in ceramica
modello Messico Dolomite e Iseo Pozzi Ginori*

*Small furniture for fire clay basin 75x60 cm
Chromed handles and chromed feet
Suitable to fire-clay basins,
model Messico Dolomite and Iseo Pozzi Ginori**

*Tutti i nomi e marchi riportati in questo catalogo appartengono ai legittimi proprietari o licenziatari per il commercio e sono acquistabili presso i normali canali di vendita
*All names and trademarks mentioned in this catalog belong to the rightful owners or licensees for trade and can be purchased at the normal sales channels



Dimensioni esterne / external dimensions 45 x 50 cm

Profondita' 23,5 cm

Dimensioni interne / internal dimensions 37 x 32,5 cm

Art.	EAN
2030	8029954006731



Dimensioni esterne / external dimensions 45 x 60 cm

Profondita' 22,5 cm

Dimensioni interne / internal dimensions 36 x 41,5 cm

Art.	EAN
2029	8029954006748



Dimensioni esterne / external dimensions 50 x 50 cm

Profondita' 23,5 cm

Dimensioni interne / internal dimensions 39,5 x 32,5 cm

Art.	EAN
2023	8029954006755

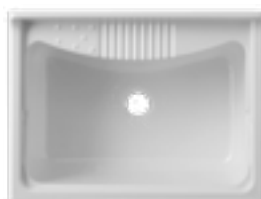

Dimensioni esterne / external dimensions 60 x 45 cm

Profondita' 21,5 cm

Dimensioni interne / internal dimensions 52 x 33 cm

Art.	EAN
2032	8029954006762

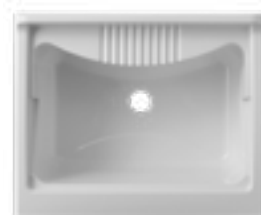

Dimensioni esterne / external dimensions 60 x 50 cm

Profondita' 23,5 cm

Dimensioni interne / internal dimensions 51,5 x 34 cm

Art.	EAN
2028	8029954006779



Vasche



Dimensioni esterne / *external dimensions* 60 x 60 cm

Profondita' 23,5 cm

Dimensioni interne / *internal dimensions* 52 x 45 cm

Art.	EAN
2031	8029954006786



Dimensioni esterne / *external dimensions* 75 x 60 cm

Profondita' 28,5 cm

Dimensioni interne / *internal dimensions* 64,5 x 54,5 cm

Art.	EAN
2021	8029954006816



Dimensioni esterne / *external dimensions* 75 x 60 cm

Profondita' 22,5 ; 19,5 cm

Dimensioni interne / *internal dimensions* 36 x 41,5 cm ;
24 x 41,5 cm

Art.	EAN
2024	8029954006823



Dimensioni esterne / *external dimensions* 80 x 50 cm

Profondita' 26 cm

Dimensioni interne / *internal dimensions* 71 x 39,5 cm

Art.	EAN
2027	8029954006793



Dimensioni esterne / *external dimensions* 80 x 50 cm

Profondita' 26 cm

Dimensioni interne / *internal dimensions* 69 x 38 cm

Art.	EAN
2033	8029954006809

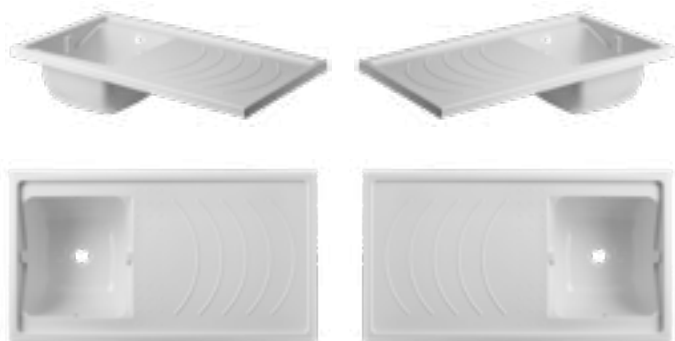

Dimensioni esterne / *external dimensions* 109 x 60 cm

Profondita' 22,5 cm

Dimensioni interne / *internal dimensions* 36,5 x 42,5 cm

Art.	EAN
2035	8029954007295

Reversibile / Reversible



Dimensioni esterne / *external dimensions* 124 x 60 cm

Profondita' 22,5 cm

Dimensioni interne / *internal dimensions* 50,5 x 42,5 cm

Art.	EAN
2036	8029954007035

Reversibile / Reversible



Vasca in CERAMICA - CERAMIC basin

Dimensioni esterne / *external dimensions* 62 x 55 cm

Profondita' 26 cm

Dimensioni interne / *internal dimensions* 46 x 42 cm

Art.	EAN
2028K	8029954008131



Assi per vasche

Asse in resina speciale 38,4x35 cm
Plastic washing board 38,4x35 cm



Art.	EAN
2040CR	8029954007097

Asse in pino verniciato 38,4x34,7 cm
Wooden washing board 38,4x34,7 cm



Art.	EAN
2040	8029954006922

Asse in resina speciale 40,8x35 cm
Plastic washing board 40,8x35 cm



Art.	EAN
2038CR	8029954007103

Asse in pino verniciato 41,4x35 cm
Wooden washing board 41,4x35 cm



Art.	EAN
2038	8029954006939

Asse in resina speciale 53,5x35,5 cm
Plastic washing board 53,5x35,5 cm



Art.	EAN
2042CR	8029954007301

Asse in pino verniciato 53,5x34,8 cm
Wooden washing board 53,5x34,8 cm



Art.	EAN
2042	8029954006946

Asse in pino verniciato 66,3x35,9 cm
Wooden washing board 66,3x35,9 cm



Art.	EAN
2056	8029954006977

Asse in pino verniciato 69,3x34,9 cm
Wooden washing board 69,3x34,9 cm



Art.	EAN
2037	8029954006953

Asse in pino verniciato 71,8x34,9 cm
Wooden washing board 71,8x34,9 cm



Art.	EAN
2054	8029954006960

Asse in pino verniciato 54x31,5 cm
Wooden washing board 54x31,5 cm



Art.	EAN
2042K	8029954059379

• Vedi pagina 253 per compatibilità assi/vasche - See page 253 for compatibility washing boards/basins

PORTASCIUGAMANO CROMATO PER LAVATOI - CHROMED TOWEL RACK FOR FURNITURES



Art.	EAN
PORTASAL	8029954007899

PORTASAPONE PER VASCA IN CERAMICA - SOAP DISH FOR CERAMIC SINK

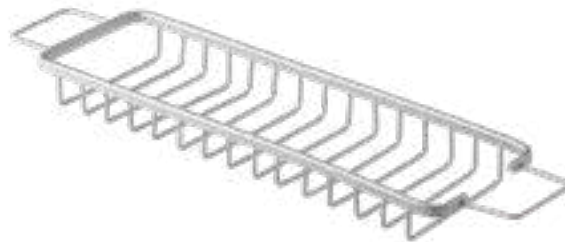
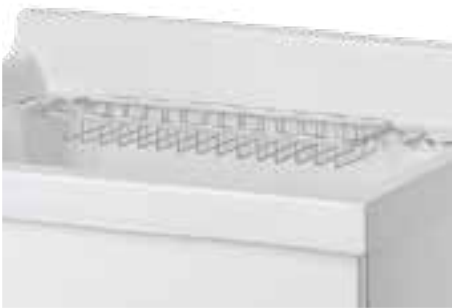

Art.	EAN
PORTASAPK	8029954003198

CESTELLO MULTI-USO - MULTI-PURPOSE HAMPER



Art.	EAN
2020	8029954007028

GRIGLIA PER MICRO E SLIM - GRID FOR MICRO AND SLIM



- Dimensioni griglia: 36,5 x 29,8 x h 1,6 cm
- Griglia multiuso compatibile con art. 5001PMC, 5000PKC, 5000PMC
- Grid dimensions: 36,5 x 39,8 x h 1,6 cm
- Multipurpose grid suitable with art. 5001PMC, 5000PKC, 5000PMC

Art.	EAN
2052	8029954005987



Ricambi scarico lavatoi

Kit scarico lavatoi con dettagli bianchi - Washbasins drain kit with white details

Completo di:

- Sifone a U, 1 via con attacco lavastoviglie
- Piletta con gattinara bianca e troppopieno flessibile tondo lungo 35 cm con griglia bianca
- Tappo bianco

Complete with:

- U siphon, one way with dishwasher coupling
- Drain with white grid and flexible round overflow 35 cm long, with white small grid
- White plug

Art.	EAN
5222LB	8029954007479

Kit scarico lavatoi con dettagli inox - Washbasins drain kit with stainless steel details

Completo di:

- Sifone a U, 1 via con attacco lavastoviglie
- Piletta con gattinara in acciaio inox e troppopieno flessibile tondo lungo 35 cm con griglia inox
- Tappo nero

Complete with:

- U siphon, one way with dishwasher coupling
- Drain with stainless steel grid and flexible round overflow 35 cm long, with stainless steel small grid
- Black plug

Art.	EAN
5222LX	8029954007776

Kit scarico lavatoio bivasca 75x60 con dettagli inox - Double basin drain kit with stainless steel details

Completo di:

- Sifone a U, 2 vie altezze diverse con attacco lavastoviglie
- 2 pilette con gattinara in acciaio inox e troppopieno flessibile tondo lungo 35 cm con griglia inox
- Tappo nero

Complete with:

- U siphon, 2 ways with different heights and dishwasher coupling
- 2 drains with stainless steel grid and flexible round overflow 35 cm long, with stainless steel small grid
- Black plug

Art.	EAN
2UW-01P26C2T14	8029954007783

Kit scarico lavatoio in ceramica con tappo copriforo e dettagli inox - Ceramic basin drain kit with cover plug and stainless steel details

Completo di:

- Sifone a U, 1 via con attacco lavastoviglie
- Pilettone ribassato vite 28 mm con gattinara in acciaio inox e troppopieno flessibile tondo lungo 45 cm con griglia inox
- Tappo copriforo per ceramica rivestito inox con filetto alto

Complete with:

- U siphon, one way with dishwasher coupling
- Drain with stainless steel grid, 28 mm screw and flexible round overflow 45 cm long, with stainless steel small grid
- Cover plug for ceramic hole coated with stainless steel

Art.	EAN
1UWP71C7T15S119-24	8029954007783

Dimensioni vasche lavatoi - Sink dimensions

Art.	Dimensioni esterne (larghezza x sporgenza dal muro) External sizes (width x protusion from wall)	Profondita' vasca (in corrispondenza della piletta) Sink depth	Dimensioni interne (larghezza x lunghezza) Internal sizes (width x length)
2030	45x50 cm	23,5 cm	37 x 32,5 cm
2029	45x60 cm	22,5 cm	36 x 41,5 cm
2023	50x50 cm	23,5 cm	39,5 x 32,5 cm
2032	60x45 cm	21,5 cm	52 x 33 cm
2028	60x50 cm	23,5 cm	51,5 x 34 cm
2031	60x60 cm	23,5 cm	52 x 45 cm
2021	75x60 cm tutta vasca	28,5 cm	64,5 x 54,5 cm
2024	75x60 cm a due vasche	22,5 ; 19,5 cm	36 x 41,5 cm ; 24 x 41,5 cm
2027	80x50 cm con discesina	26 cm	71 x 39,5 cm
2033	80x50 cm tutta vasca	26 cm	69 x 38 cm
2035	109x60 cm coprilavatrice reversibile	22,5 cm	36,5 x 42,5 cm
2036	124x60 cm coprilavatrice reversibile	22,5 cm	50,5 x 42,5 cm
2028K	62x55 ceramica	26 cm	46 x 42 cm

Dimensioni assi lavatoi e compatibilità con vasche CR - Compatibility table

Materiale asse Washing board material												
Dimensioni asse Washing board sizes		38,4x34,7	38,4x35	41,4x35	40,8x35	53,5x35	53,5x35	66,3x35,9	69,3x34,9	71,8x34,9	54x31,5	
Art. vasca Art. Basin	Dimensioni esterne vasca Basin external sizes	Art. Asse Art. Washing Board	2040	2040CR	2038	2038CR	2042	2042CR	2056	2037	2054	2042K
2030	45x50 cm		✓	✓								
2029	45x60 cm		✓	✓								
2023	50x50 cm				✓	✓						
2032	60x45 cm						✓	✓				
2028	60x50 cm						✓	✓				
2031	60x60 cm						✓	✓				
2021	75x60 cm tutta vasca								✓			
2024	75x60 cm a due vasche		✓	✓								
2027	80x50 cm con discesina									✓		
2033	80x50 cm tutta vasca										✓	
2035	109x60 cm coprilavatrice reversibile		✓	✓								
2036	124x60 cm coprilavatrice reversibile						✓	✓				
2028K	62x55 ceramica											✓



LEGENDA

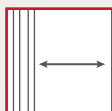

Ampia apertura
Large opening

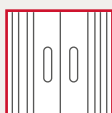

Perfetto parallelismo dei pannelli
all'apertura e alla chiusura del box
*Profiles are always parallel during
opening and closing of the box*



Viti acciaio inox
Stainless steel screws

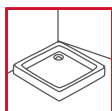

Montaggio semplice anche con parete
e piatto doccia non perpendicolari
*Easy assembly also if wall and shower
tray are not perpendicular*



Indistruttibile e sicuro
Unbreakable and safe



Completo di istruzioni di montaggio
Complete with mounting instructions



Pulibile con qualsiasi prodotto per la casa
Cleanable with every kind of product



Imballo compatto e leggero
Compact and light packaging



Semplice da trasportare e da immagazzinare
Easy to transport and stock



Realizzabili anche su misura
per ogni tua esigenza
*Customizable measures for
all your needs*



Adattabili anche a piatti doccia molto
piccoli o di misure non comuni
*It fits also to very small shower trays or
strange dimensions*

BOX DOCCIA E VASCA SHOWER AND BATH CABIN

La comodità di utilizzo e la sicurezza dell'utente si sposano con una adattabilità senza precedenti grazie alla modularità del prodotto

The user's comfort and safety are combined with unprecedented adaptability thanks to the modularity of the product

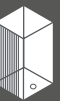

SUPERBRUCO

Box doccia estensibile - Adjustable folding shower cabin

- Adattabile con foderi estensibili
- Permette un'estensibilità di 12 cm per lato (24 cm per modulo porta)
- Maniglie ad incasso, chiusura con guarnizione in gomma
- Nel caso sia necessario raggiungere misure inferiori a quelle espresse nel catalogo, è sempre possibile tagliare le guide inferiori e superiori, sfilando gli eventuali pannelli in eccesso

- Adjustable by extensible sleeves
- It allows 12 cm extensibility for each side (for door 24 cm)
- Built-in door-handle, closing with rubber gasket
- In case of shorter sizes it is possible to reduce dimensions also by cutting the sliding rails

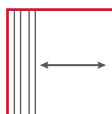

Ampia apertura per un comodo accesso alla doccia e alla vasca
Large opening for easy access to shower

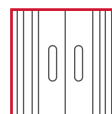

Perfetto parallelismo dei pannelli all'apertura e alla chiusura del box
Profiles are always parallel during opening and closing of the box



Viti acciaio inox
Stainless steel screws

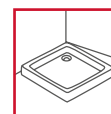

Montaggio semplice anche con parete e piatto doccia non perpendicolari
Easy assembly also if wall and shower tray are not perpendicular

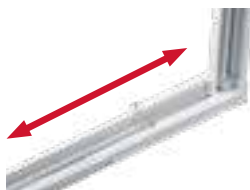

Porta - Door

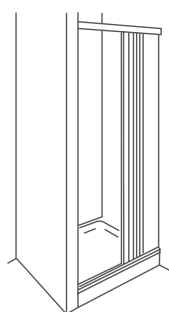

h 184

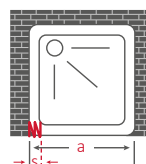

Apertura reversibile
Reversible opening

Art.	a	s	EAN
B1S90	68-92	23,8	8029954020218
B1S116	92-116	27,8	8029954020225
B1S140	116-140	29,8	8029954020232



Due lati - Two sides

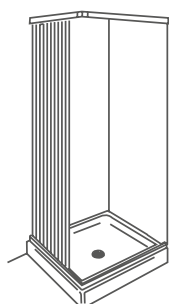

h 184

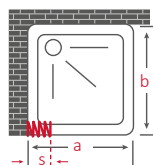

Dx destro / right

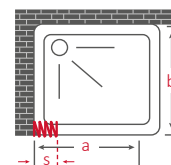

Lato destro corto
Right side shorter

Sx sinistro / left

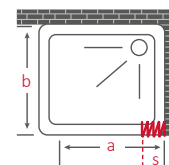

Lato sinistro corto
Left side shorter

Apertura reversibile
Reversible opening

Art.	a	b	dx - sx	s	EAN
B2S80	68-80	68-80		31,8	8029954020249
B2S90D	80-92	68-80	Dx lato destro corto right side shorter	33,8	8029954020256
B2S90S	80-92	68-80	Sx lato sinistro corto left side shorter	33,8	8029954020263
B2S92	80-92	80-92		35,8	8029954020270
B2S100	92-102	92-102		37,8	8029954020287



Indistruttibile e sicuro
Unbreakable and safe



Completo di istruzioni di montaggio
Complete with mounting instructions



Pulibile con qualsiasi prodotto per la casa
Cleanable with every kind of product



Imballo compatto e leggero
Compact and light packaging



Semplice da trasportare e da immagazzinare
Easy to transport and stock



Realizzabili anche su misura per ogni tua esigenza
Customizable measures for all your needs

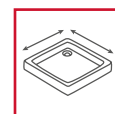

Adattabili anche a piatti doccia molto piccoli o di misure non comuni
It fits also to very small shower trays or strange dimensions



Tre lati - Three sides

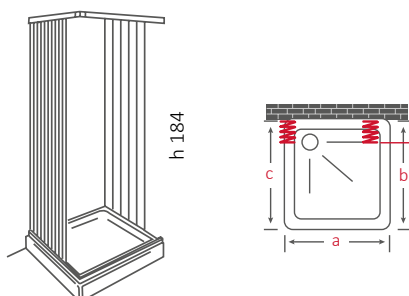

Apertura centrale
Central opening

Art.	a	b	c	s	EAN
B3S80	80	68-80	68-80	41,8	8029954020294
B3S90	90	80-92	80-92	45,8	8029954020300



Semicircolare - Semicircular

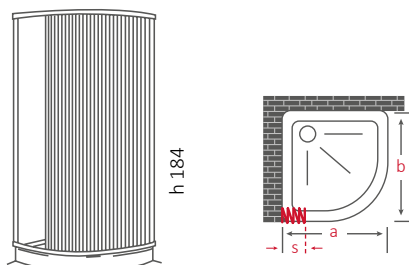

Apertura reversibile
Reversible opening

Art.	a	b	s	EAN
B4S80	78	78	29,8	8029954020317
B4S90	78-90	78-90	33,8	8029954020324



SUPERBRUCO

Box vasca estensibile - Adjustable folding bath cabin

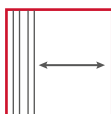

Ampia apertura
per un comodo
accesso alla vasca
Large opening
for easy access
to bath

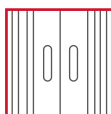

Perfetto parallelismo
dei pannelli all'apertura
e alla chiusura del box
Profiles are always
parallel during opening
and closing of the box



Viti acciaio inox
Stainless steel
screws



Indistruttibile
e sicuro
*Unbreakable
and safe*

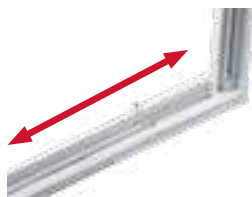

- Adattabile con foderi estensibili
- Permette un'estensibilità di 12 cm per lato (24 cm per modulo porta)
- Maniglie ad incasso, chiusura con guarnizione in gomma
- Nel caso sia necessario raggiungere misure inferiori a quelle espresse nel catalogo, è sempre possibile tagliare le guide inferiori e superiori, sfilando gli eventuali pannelli in eccesso

- Adjustable by extensible sleeves
- It allows 12 cm extensibility for each side (for door 24 cm)
- Built-in door-handle, closing with rubber gasket
- In case of shorter sizes it is possible to reduce dimensions also by cutting the sliding rails



Porta - Door

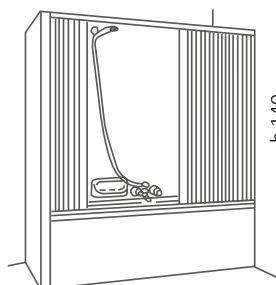

Apertura reversibile
Reversible opening

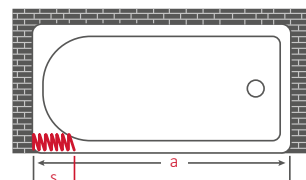

Art.	a	s	EAN
BV1S140	118-142	31,8	8029954020331
BV1S170	146-170	35,8	8029954020348



Completo di istruzioni di montaggio
Complete with mounting instructions



Pulibile con qualsiasi prodotto per la casa
Cleanable with every kind of product



Imballo compatto e leggero
Compact and light packaging



Semplice da trasportare e da immagazzinare
Easy to transport and stock



Realizzabili anche su misura per ogni tua esigenza
Customizable measures for all your needs

Due lati - Two sides

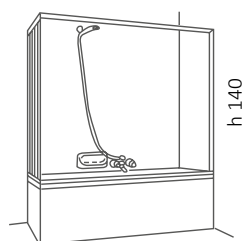

Apertura reversibile
Reversible opening

Dx: Lato destro corto
Right side shorter

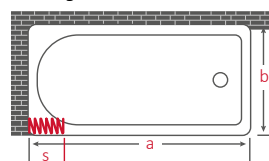

Sx: Lato sinistro corto
Left side shorter

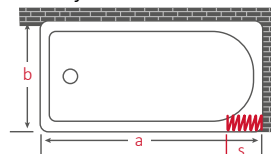

Art.	a	b	Dx - Sx	s	EAN
BV2S140D	130-142	68-80	Dx lato destro corto right side shorter	41,8	8029954020355
BV2S170D	158-170	68-80	Dx lato destro corto right side shorter	47,8	8029954020379
BV2S140S	130-142	68-80	Sx lato sinistro corto left side shorter	41,8	8029954020362
BV2S170S	158-170	68-80	Sx lato sinistro corto left side shorter	47,8	8029954020386

Tre lati - Three sides

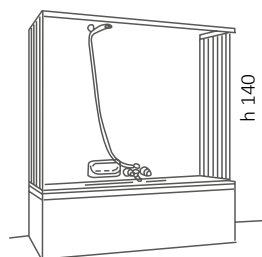

Apertura centrale
Central opening

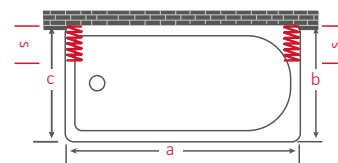

Art.	a	b	c	s	EAN
BV3S140	140	68-80	68-80	32,8	8029954020393
BV3S170	170	68-80	68-80	34,8	8029954020409



BRUCO

Box doccia riducibile - Adjustable folding shower cabin



- Con il semplice taglio delle guide di scorrimento è possibile ottenere misure inferiori a quelle indicate in catalogo

- It's possible to reach lower sizes simply by cutting the sliding rails

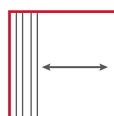

Ampia apertura per un comodo accesso alla doccia e alla vasca
Large opening for easy access to shower

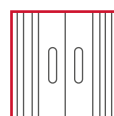

Perfetto parallelismo dei pannelli all'apertura e alla chiusura del box
Profiles are always parallel during opening and closing of the box



Viti acciaio inox
Stainless steel screws

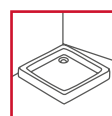

Montaggio semplice anche con parete e piatto doccia non perpendicolari
Easy assembly also if wall and shower tray are not perpendicular

Porta - Door

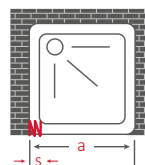
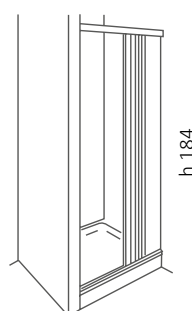

Apertura reversibile
Reversible opening

Art.	a	s	EAN
B1B75	75	21,8	8029954020003
B1B80	80	23,8	8029954020010
B1B90	90	25,8	8029954020027
B1B120	120	27,8	8029954020034

Due lati - Two sides

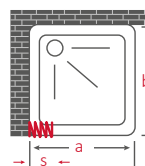
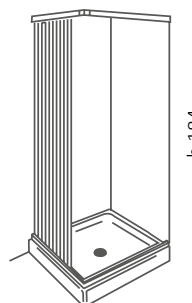

Apertura reversibile
Reversible opening

Art.	a	b	s	EAN
B2B75	75	75	29,8	8029954020041
B2B80	80	80	31,8	8029954020058
B2B90	90	90	33,8	8029954020065



Indistruttibile e sicuro
Unbreakable and safe



Completo di istruzioni di montaggio
Complete with mounting instructions



Pulibile con qualsiasi prodotto per la casa
Cleanable with every kind of product



Imballo compatto e leggero
Compact and light packaging



Semplice da trasportare e da immagazzinare
Easy to transport and stock



Realizzabili anche su misura per ogni tua esigenza
Customizable measures for all your needs

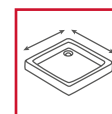

Adattabili anche a piattini doccia molto piccoli o di misure non comuni
It fits also to very small shower trays or strange dimensions



Tre lati - Three sides

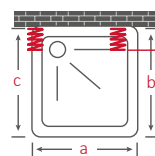
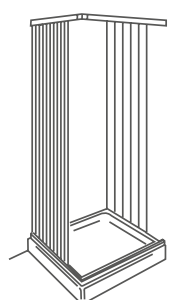

Apertura centrale
Central opening

Art.	a	b	c	s	EAN
B3B70	70	70	70	23,8	8029954020072
B3B80	80	80	80	25,8	8029954020089
B3B90	90	80	80	27,8	8029954020096



Semicircolare - Semicircular

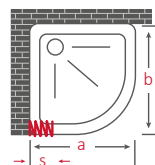
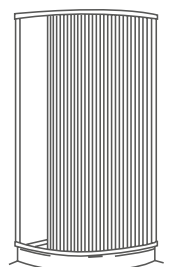

Apertura reversibile
Reversible opening

Art.	a	b	s	EAN
B4B80	80	80	31,8	8029954020119
B4B90	90	90	35,8	8029954020126



BRUCO

Box vasca riducibile - Adjustable folding bath cabin

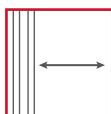

Ampia apertura
per un comodo
accesso alla vasca
Large opening
for easy access
to bath

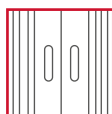

Perfetto parallelismo
dei pannelli all'apertura
e alla chiusura del box
Profiles are always
parallel during opening
and closing of the box



Viti acciaio inox
Stainless steel
screws



Indistruttibile
e sicuro
*Unbreakable
and safe*



- Con il semplice taglio delle guide di scorrimento è possibile ottenere misure inferiori a quelle indicate in catalogo

- It's possible to reach lower sizes simply by cutting the sliding rails



Porta - Door

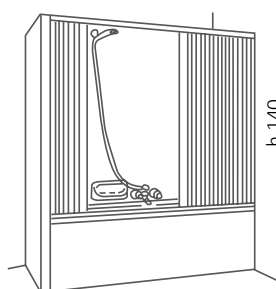

Apertura reversibile
Reversible opening

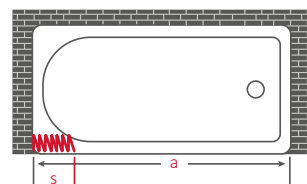

Art.	a	s	EAN
BV1B140	140	29,8	8029954020133
BV1B170	170	33,8	8029954020140



Completo di istruzioni di montaggio
Complete with mounting instructions



Pulibile con qualsiasi prodotto per la casa
Cleanable with every kind of product



Imballo compatto e leggero
Compact and light packaging



Semplice da trasportare e da immagazzinare
Easy to transport and stock



Realizzabili anche su misura per ogni tua esigenza
Customizable measures for all your needs

Due lati - Two sides

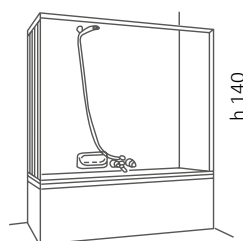

Apertura reversibile
Reversible opening

Dx: Lato destro corto
Right side shorter

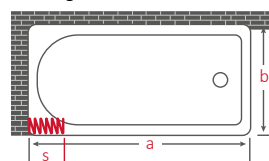

Sx: Lato sinistro corto
Left side shorter

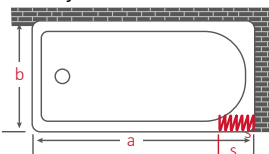

Art.	a	b	dx - sx	s	EAN
BV2B140D	140	75	Dx lato destro corto right side shorter	39,8	8029954020157
BV2B170D	170	75	Dx lato destro corto right side shorter	43,8	8029954020171
BV2B140S	140	75	Sx lato sinistro corto left side shorter	39,8	8029954020164
BV2B170S	170	75	Sx lato sinistro corto left side shorter	43,8	8029954020188

Tre lati - Three sides

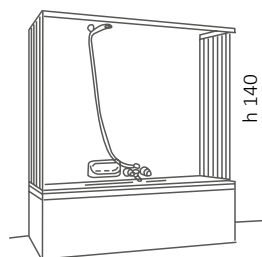

Apertura centrale
Central opening

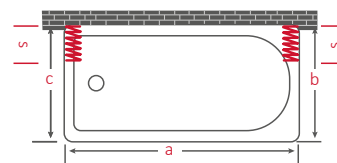

Art.	a	b	c	s	EAN
BV3B140	140	75	75	29,8	8029954020195
BV3B170	170	75	75	31,8	8029954020201



INDICE ARTICOLI
ARTICLE INDEX



CR

INDICE ARTICOLI - ARTICLE INDEX

Art.	Pag.
1030	32
1034	34
1037	61
1041	52
1042	65
1046	54
1050	48
1051	48
1057	64
1070	46
1077	63
1080	30
1081	30
1083	20
1084	20
1085	18
1086	18
1087	60
1100	178
1103	180
1104	175
1105	179
1106	181
1107	177
1109	176
1150	227
1220	167
1221	167
1402	114
1403	114
1406	106
1407	107
1501	92
1502	94
1503	94
1504	99
1505	100

Art.	Pag.
1508	96
1510	82
1513	78
1518	89
1519	97
1520	84
1526	119
1527	119
1537	119
1545	182
1546	184
1549	185
1550	110
1560	56-65
1641	167
1700	166
1701	166
1702	166
1703	166
1704	166
1705	166
1706	166
2016	246
2017	246
2020	251
2021	248
2023	247
2024	248
2027	248
2028	247
2029	247
2030	247
2031	248
2032	247
2033	248
2035	249
2036	249

Art.	Pag.
2037	250
2038	250
2040	250
2042	250
2051	188
2052	189, 232-233
2054	250
2056	250
4001	230
4002	230
4003	230
4005	230
4006	230
4007	230
4010	230
5014	128
5016	128
5082	127
5083	126
5084	127
5085	126
5086	125
5087	130
5088	131
5089	131
5111	160
5112	160
7002	215
7003	215
7006	215
7007	215
8005	141
8006	141
8008	141
8009	141
9001	225
9002	224

Art.	Pag.
9003	224
9006	224
9007	224
9010	225
9042	221
9043	221
9046	221
9047	221
1000AC	50
1000C1	14
1000C1PE	38
1000C1PI	38
1000C2	16
1000C2/07	16
1000C2IDRO	44
1000C2CH	16
1000MC1	40
1000MC2	42
1000S1	22
1000S2	24
1001S1	22
1001S2	24
1007C1	56
1007C2	56
1007S1	58
1007S2	58
1030CH	32
1030S	26
1030S2	28
1031S	26
1031S2	28
1037S	59-60
1037S2	59
1041S	52
1060F	68
1060FA	72
1060FP	68

Art.	Pag.
1060FU	70
1061B2	74
1061C2	74
1061P	74
1062F	75
1063F	75
1065F	75
1087S	57
1087S2	57
1104X	175
1107CH	177
1108E	173
1108F	171
1108G	172
1108SC	170
1108X	174
1109X	176
1185N/01	111
1400B	57-64
1400B2	59
1400C	56-63
1400F	58
1400G	56-64
1400H	57
1401A	65
1401C	65
1402A	115
1402B	116
1402C	117
1402T	118
1403A	115
1403B	116
1403C	117
1403T	118
1407SG	107
1408G	108
1408X	108

Art.	Pag.
1500A	98
1500AC	98
1500ARB	101
1500B	98
1500BC	98
1500C	99
1500CC	99
1501A	92
1501B	93
1501BLACC	93
1503A	95
1503B	95
1505M	100
1506B	69
1507A	97
1508CH	96
1510A	82
1510AP	82
1510L	82
1510NF	87
1510P	82
1511L	88
1513A	78
1513AP	78
1513IT	78
1513L	78
1514AP	80
1514L	80
1514P	80
1515B	86
1515C	86
1515D	86
1515E	86
1516C	110
1518A	89
1518B	89
1518C	89

INDICE ARTICOLI - ARTICLE INDEX

Art.	Pag.	Art.	Pag.	Art.	Pag.
1518D	89	1535/02-10	59,104	2002FCG	202
1518E	89	1535-10	56-64,104	2002FMV	202
1518H	89	1536-10	65,104	2003FB	202
1520A	84	1538-10	56-64,104	2003FCG	202
1520AP	84	1539-10	105	2003FMV	202
1520L	84	1540-10	56-65,105	2005A	202
1520P	84	1543-10	105	2005ACR	198
1521-10	56-65	1540D	119	2005ALE	198
1522-10	65	1540V-10	105	2005ASG	198
1522A-10	64	15420-10	88	2005AVL	198
1523-10	102	1542R2-10	88	2005FB	198
1523A-10	102	1542R3-10	88	2005FCG	202
1524-10	103	1542S-10	88	2005FMV	202
1524A-10	103	1545B	182	2006A	202
1524B-10	103	1545E	182	2006ACR	198
1526QF	62,63-119	1545F	182	2006ALE	198
1526X	119	1545G	183	2006ASG	198
1527/02	119	1545HTF	183	2006AVL	198
1530A	119	1545L	183	2006FB	198
1530B	119	1545NTF	183	2006FCG	202
1530C	119	1545QF	184	2006FMV	202
1530D	119	1545S	184	2007A	202
1531A	61,64	1546B	184	2007ACR	198
1531D	63	1546E	185	2007ALE	198
1531E	60	1546F	185	2007ASG	198
1531F3	58	1546G	185	2007AVL	198
1531N	57	1546SC	185	2007FB	198
1531N3	57	1641E	167	2007FCG	202
1531R3	56-64	1UWP71C7T15S119-24	252	2007FMV	202
1531R4	56,63	2001FB	203	2008ACRDX	202
1531S	59,60	2002A	198	2008ACRSX	199
1531S2	59	2002ACR	198	2008ADX	199
1531-10	64-65	2002ALE	198	2008ALEDX	199
1532-10	56-64	2002ASG	198	2008ALESX	199
1532A-10	65	2002AVL	198	2008ASGDX	199
1533-10	56-64	2002BCER	204	2008ASGSX	199
1533A-10	65	2002FB		2008ASX	199

Art.	Pag.
2008AVLDX	199
2008AVLSX	199
2008FBDX	199
2008FBSX	203
2008FCGDX	203
2008FCGSX	203
2008FMVDX	203
2008FMVSX	203
2009FB	203
2009FCG	202
2009FMV	202
2010FB	202
2012FB	203
2012FCG	202
2012FMV	202
2013FB	202
2013FCG	202
2013FMV	202
2028K	202
2038CR	249
2040CR	250
2042CR	250
2042K	250
2051A	250
2051AG	188
2051AM	188
2051B	188
2051BG	189
2051BM	189
2051G	189
2051M	188
2052G	188
2052M	188
2800ACRDX	188
2800ACRSX	199
2800ADX	199
2800ALEDX	199

Art.	Pag.
2800ALESX	199
2800ASGDX	199
2800ASGSX	199
2800ASX	199
2800AVLDX	199
2800AVLSX	199
2800FBDX	199
2800FBSX	203
2800FCGDX	203
2800FCGSX	203
2800FMVDX	203
2800FMVSX	203
2UW-01P26C2T14	203
3001SB	252
3001SO	213
3002SB	213
3002SO	212
3003SB	212
3003SO	212
3005SB	212
3005SO	212
3006SB	212
3006SO	212
3007SB	212
3007SO	212
3008SBDX	212
3008SBSX	213
3008SODX	213
3008SOSX	213
3009SB	213
3010SB	212
3010SO	213
3012SB	213
3012SO	212
3013SB	212
3013SO	212
3310-10	212

Art.	Pag.
3310B-10	161
3311-10	161
3312-10	161
3313-10	161
3800SBDX	161
3800SBSX	213
3800SODX	213
3800SOSX	213
4002K	213
4003K	230
4006K	230
4007K	230
4008DX	230
4008SX	231
4800DX	231
4800SX	231
5000PK	231
5000PKC	192
5000PMC	192,232
5001PMC	233
5008A	232
5008P	241
5010P	240
5011P	244
5012CL	243
5012FPL/02	129
5012P	129
5012PL	242
5013P	129
5086RVG	245
5087RVG	133
5222LB	133
5222LX	269
6002SK	269
6003SK	217
6006SK	217
6007SK	217

INDICE ARTICOLI - ARTICLE INDEX

Art.	Pag.
8000-20	217
8002-20	140
8006RS40	140
8008/O	141
8009/O	141
8058LB	141
8058LG	193
8058LX	193
9002F	193
9002K	224
9002KF	224
9002KR	224
9002KW	224
9002R	224
9002W	224
9003K	224
9006K	224
9007K	224
9008DX	224
9008K	225
9008SX	225
9800DX	225
9800SX	225
B1B120	225
B1B75	260
B1B80	260
B1B90	260
B1S116	260
B1S140	256
B1S90	256
B2B75	256
B2B80	260
B2B90	260
B2S100	260
B2S80	256
B2S90D	256
B2S90S	256

Art.	Pag.
B2S92	256
B3B70	256
B3B80	261
B3B90	261
B3S80	261
B3S90	257
B4B80	257
B4B90	261
B4S80	261
B4S90	257
BV1B140	257
BV1B170	262
BV1S140	262
BV1S170	258
BV2B140D	258
BV2B140S	263
BV2B170D	263
BV2B170S	263
BV2S140D	263
BV2S140S	259
BV2S170D	259
BV2S170S	259
BV3B140	259
BV3B170	263
BV3S140	263
BV3S170	259
C1B	259
C1B2	148
C1B2-M	134
C1BP32C2	134
C1BW	150
C1BWP32C2	148
C1F	150
C1FP32C2	152
C1FW	154
C1FWP32C2	152
C1LUW	154

Art.	Pag.
C1LUW-S	156
C1U	156
C1U3	144
C1U3-M	135
C1UP32C2	135
C1UW	146
C1UWP32C2	144
C1X10	146
C1X12	136
C1X13	137
C1X14	137
C1X17	137
C1X18	137
C1X19	137
C1X2	137
C1X20	136
C1X2M	137
C1X3	136
C1X3M	136
C1X4	136
C1X4M	136
C1X4P1C1	136
C1X6	138
C1X6M	136
C1X8	136
C1X8M	136
C1X8P32C2	136
C1X8P3C2	138
C1X8P68C7	138
C1X9	138
C1X9M	136
C1X9P32C2	136
C1X9P3C2	138
C1X9P68C7	138
C2B	138
C2BP32C2	149
C2BW	151

Art.	Pag.
C2BWP32C2	149
C2F	151
C2FP32C2	153
C2FW	155
C2FWP32C2	153
C2LUW-01	155
C2LUW-01S	156
C2U	156
C2UP32C2	145
C2UW	147
C2UWP32C2	145
C2X8	147
C2X8P32C2	137
C2X8P3C2	139
C2X8P68C7	139
C2X9	139
C2X9P32C2	137
C2X9P3C2	139
C2X9P68C7	139
CP11C2	139
CP1C1	158
CP26C2T17	135
CP26C2T3	159
CP32C2	158
CP68C7	159
CP72C7T17	157
CP72C7T3	157
EXPO01	157
EXPO02	272
EXPO03	272
EXPO05	273
EXPO05C	273
EXPO05J	273
EXPO05M	273
EXPO07	273
EXPO08/01	272
EXPO09	272

Art.	Pag.
F760P	272
F760PF	227
F760PR	226
F760PW	226
G19-10	226
G24-10	165
G3-10	165
G4-10	165
G5-10	65,105,165
G7-10	165
G8-10	165
GF1-10	165
IDROKIT	165
M12	111
M14	165
M20	165
M21	164
M22	164
M33	164
PE	164
PEC	62,75,108
PI	109
PIC	62,75,108
PORTASAL	75,109
PORTASAPK	251
PPE	204,251
PPI	109
R21	75, 109
R27	164
R31	164
R40	164
R400K	164
R400KG	123
R400X	132
R400XG	123
R5	132
R500K	164

Art.	Pag.
R500KG	123
R500X	132
R500XG	123
R700K	132
R700KG	123
R700X	132
R700XG	123
R800K	132
R800KG	123
R800X	132
R800XG	123
R900K	132
R900KG	123
R900X	132
R900XG	123
RVG	132
SCAT18	133
SM0158	162, 271
TAPGR18	110
	163, 271

ESPOSITORI



Art. / Item	Descrizione / Models	EAN
EXPO01	Espositore in metallo per 3 cassette esterne <i>Metal display for 3 exposed cisterns</i>	8029954011827
EXPO02	Espositore da banco in plexiglass per cassetta esterna <i>Desk plexi display for exposed cistern</i>	8029954011834

Art. / Item	Descrizione / Models	EAN
EXPO09	Espositore da banco per galleggianti Nanotek con 2 galleggianti montati <i>Desk plexi display for Nanotek filling valves with 2 samples mounted</i>	8029954011841



Art. / Item	Descrizione / Models	EAN
EXPO07	Espositore in legno per linea canaline Nilo <i>Wood display for Nilo shower drains</i>	8029954011858
EXPO08/01	Espositore da banco in plexiglass con canalina Nilo R400X sezionata <i>Desk plexi display with sectioned shower drain Nilo R400X</i>	8029954011865







Fornito con un sedile montato e spazio per 12 pezzi
 Supplied with one mounted toilet seat and entry space for 12 pcs

Art. / Item	Descrizione / Models	EAN
EXPO05	Espositore in legno per Everest con 1 sedile montato <i>Wood display for Everest with one toilet seat</i>	8029954011872
EXPO05J	Espositore in legno per Java con 1 sedile montato <i>Wood display for Java with one toilet seat</i>	8029954011889
EXPO05M	Espositore in legno per Malaga con 1 sedile montato <i>Wood display for Malaga with one toilet seat</i>	8029954011896
EXPO05C	Espositore in legno per Creta con 1 sedile montato <i>Wood display for Creta with one toilet seat</i>	8029954011902

Art. / Item	Descrizione / Models	EAN
EXPO03	Espositore in metallo per 3 pilozzi <i>Metal display for 3 utility sinks</i>	8029954011919



Art. / Item	Descrizione / Models	Ø griglia / Ø grid	Per piletta / For drain			EAN
SCAT18	Espositore completo di 18 pz Scattino <i>Display with 18 pcs "Scattino"</i>	Ø80	3"1/2	2	23,5x23,5x31	8032642520556
TAPGR18	Espositore completo di 18 pz Tap-gril <i>Display with 18 pcs "Tap-gril"</i>	Ø50	2"	2	20x20x27	8032642520662

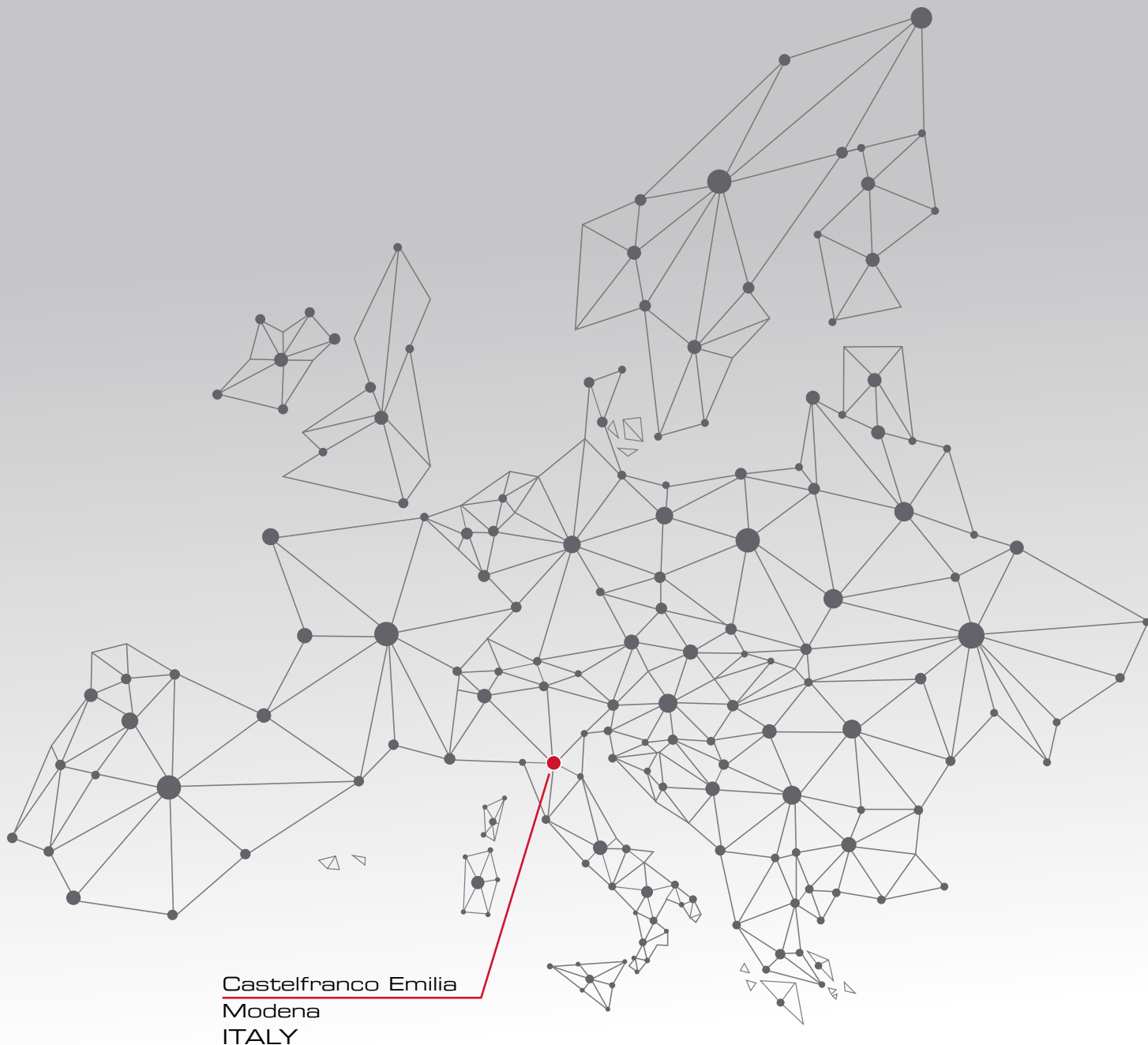

Castelfranco Emilia
Modena
ITALY



YOUR SMART
SOLUTION

C.R. srl

VIA DEI LIUTAI 3/5
41013 CASTELFRANCO EMILIA (MO)
ITALY
TEL. + 39 059 924 713
FAX +39 059 927 980
CR@CRSMART.IT
WWW.CRSMART.IT

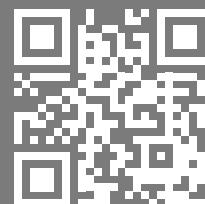

www.crsmart.it

I dati contenuti in questo catalogo possono subire variazioni o modifiche senza alcun preavviso.
I dati eventualmente riscontrati difformi non possono essere motivo di contestazione.

*The data contained in this catalog are subject to change without prior notice.
Any difference found cannot be ground for a claim.*